

ZyAIR G-4100

802.11g Wireless Hotspot Gateway

User's Guide

Version 1.00
11/2005

The logo for ZyXEL, featuring the word "ZyXEL" in a bold, blue, sans-serif font. The "Zy" is in a smaller font size than "XEL".

Copyright

Copyright © 2005 by ZyXEL Communications Corporation.

The contents of this publication may not be reproduced in any part or as a whole, transcribed, stored in a retrieval system, translated into any language, or transmitted in any form or by any means, electronic, mechanical, magnetic, optical, chemical, photocopying, manual, or otherwise, without the prior written permission of ZyXEL Communications Corporation.

Published by ZyXEL Communications Corporation. All rights reserved.

Disclaimer

ZyXEL does not assume any liability arising out of the application or use of any products, or software described herein. Neither does it convey any license under its patent rights nor the patent rights of others. ZyXEL further reserves the right to make changes in any products described herein without notice. This publication is subject to change without notice.

Trademarks

ZyNOS (ZyXEL Network Operating System) is a registered trademark of ZyXEL Communications, Inc. Other trademarks mentioned in this publication are used for identification purposes only and may be properties of their respective owners.

Interference Statements and Warnings

Federal Communications Commission (FCC) Statement

This device complies with Part 15 of FCC rules. Operation is subject to the following two conditions:

- This device may not cause harmful interference.
- This device must accept any interference received, including interference that may cause undesired operations.

FCC Warning

This equipment has been tested and found to comply with the limits for a Class B digital device pursuant to Part 15 of the FCC Rules. These limits are designed to provide reasonable protection against harmful interference in a commercial environment. This equipment generates, uses, and can radiate radio frequency energy, and if not installed and used in accordance with the instructions, may cause harmful interference to radio communications.

If this equipment does cause harmful interference to radio/television reception, which can be determined by turning the equipment off and on, the user is encouraged to try to correct the interference by one or more of the following measures:

1. Reorient or relocate the receiving antenna.
2. Increase the separation between the equipment and the receiver.
3. Connect the equipment into an outlet on a circuit different from that to which the receiver is connected.
4. Consult the dealer or an experienced radio/TV technician for help.

Notice 1

Changes or modifications not expressly approved by the party responsible for compliance could void the user's authority to operate the equipment.



Antenna Warning! This device meets ETSI and FCC certification requirements when using the included antenna(s). Only use the included antenna(s).

This Class B digital apparatus complies with Canadian ICES-003.

Cet appareil numérique de la classe B est conforme à la norme NMB-003 du Canada.

Certifications

1. Go to www.zyxel.com.
2. Select your product from the drop-down list box on the ZyXEL home page to go to that product's page.
3. Select the certification you wish to view from this page.

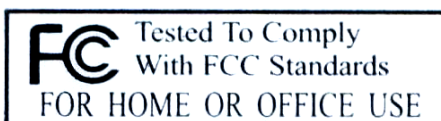

This product has been designed for the WLAN 2.4 GHz network throughout the EC region and Switzerland, with restrictions in France.



Safety Warnings

For your safety, be sure to read and follow all warning notices and instructions.

- Do NOT open the device or unit. Opening or removing covers can expose you to dangerous high voltage points or other risks. ONLY qualified service personnel can service the device. Please contact your vendor for further information.
- Connect the power cord to the right supply voltage (110V AC in North America or 230V AC in Europe).
- Place connecting cables carefully so that no one will step on them or stumble over them. Do NOT allow anything to rest on the power cord and do NOT locate the product where anyone can walk on the power cord.
- The PoE (Power over Ethernet) devices that supply or receive power and their connected Ethernet cables must all be completely indoors.
- If you wall mount your device, make sure that no electrical, gas or water pipes will be damaged.
- Do NOT install nor use your device during a thunderstorm. There may be a remote risk of electric shock from lightning.
- Do NOT expose your device to dampness, dust or corrosive liquids.
- Do NOT use this product near water, for example, in a wet basement or near a swimming pool.
- Make sure to connect the cables to the correct ports.
- Do NOT obstruct the device ventilation slots, as insufficient airflow may harm your device.
- Do NOT store things on the device.
- Connect ONLY suitable accessories to the device.

ZyXEL Limited Warranty

ZyXEL warrants to the original end user (purchaser) that this product is free from any defects in materials or workmanship for a period of up to two years from the date of purchase. During the warranty period, and upon proof of purchase, should the product have indications of failure due to faulty workmanship and/or materials, ZyXEL will, at its discretion, repair or replace the defective products or components without charge for either parts or labor, and to whatever extent it shall deem necessary to restore the product or components to proper operating condition. Any replacement will consist of a new or re-manufactured functionally equivalent product of equal or higher value, and will be solely at the discretion of ZyXEL. This warranty shall not apply if the product has been modified, misused, tampered with, damaged by an act of God, or subjected to abnormal working conditions.

Note

Repair or replacement, as provided under this warranty, is the exclusive remedy of the purchaser. This warranty is in lieu of all other warranties, express or implied, including any implied warranty of merchantability or fitness for a particular use or purpose. ZyXEL shall in no event be held liable for indirect or consequential damages of any kind to the purchaser.

To obtain the services of this warranty, contact ZyXEL's Service Center for your Return Material Authorization number (RMA). Products must be returned Postage Prepaid. It is recommended that the unit be insured when shipped. Any returned products without proof of purchase or those with an out-dated warranty will be repaired or replaced (at the discretion of ZyXEL) and the customer will be billed for parts and labor. All repaired or replaced products will be shipped by ZyXEL to the corresponding return address, Postage Paid. This warranty gives you specific legal rights, and you may also have other rights that vary from country to country.

Customer Support

Please have the following information ready when you contact customer support.

- Product model and serial number.
- Warranty information.
- Date that you received your device.
- Brief description of the problem and the steps you took to solve it.

METHOD LOCATION	SUPPORT E-MAIL	TELEPHONE ¹	WEB SITE	REGULAR MAIL
	SALES E-MAIL	FAX	FTP SITE	
CORPORATE HEADQUARTERS (WORLDWIDE)	support@zyxel.com.tw	+886-3-578-3942	www.zyxel.com www.europe.zyxel.com	ZyXEL Communications Corp. 6 Innovation Road II Science Park Hsinchu 300 Taiwan
	sales@zyxel.com.tw	+886-3-578-2439	ftp.zyxel.com ftp.europe.zyxel.com	
CZECH REPUBLIC	info@cz.zyxel.com	+420 241 091 350	www.zyxel.cz	ZyXEL Communications Czech s.r.o. Modranská 621 143 01 Praha 4 – Modrany Česká Republika
	info@cz.zyxel.com	+420 241 091 359		
DENMARK	support@zyxel.dk	+45 39 55 07 00	www.zyxel.dk	ZyXEL Communications A/S Columbusvej 5 2860 Soeborg Denmark
	sales@zyxel.dk	+45 39 55 07 07		
FINLAND	support@zyxel.fi	+358-9-4780-8411	www.zyxel.fi	ZyXEL Communications Oy Malminkaari 10 00700 Helsinki Finland
	sales@zyxel.fi	+358-9-4780 8448		
FRANCE	info@zyxel.fr	+33 (0)4 72 52 97 97	www.zyxel.fr	ZyXEL France 1 rue des Vergers Bat. 1 / C 69760 Limonest France
		+33 (0)4 72 52 19 20		
GERMANY	support@zyxel.de	+49-2405-6909-0	www.zyxel.de/	ZyXEL Deutschland GmbH. Adenauerstr. 20/A2 D-52146 Wuerselen Germany
	sales@zyxel.de	+49-2405-6909-99		
HUNGARY	mailto:support@zyxel.hu	+36-1-3361649	www.zyxel.hu/	ZyXEL Hungary 48, Zoldomb Str. H-1025, Budapest Hungary
	mailto:info@zyxel.hu	+36-1-3259100		
KAZAKHSTAN	http://zyxel.kz/support	+7-3272-590-698	www.zyxel.kz/	ZyXEL Kazakhstan 43, Dostyk ave., Office 414 Dostyk Business Centre 050010, Almaty Republic of Kazakhstan
	sales@zyxel.kz	+7-3272-590-689		
NORTH AMERICA	support@zyxel.com	+1-800-255-4101 +1-714-632-0882	www.us.zyxel.com ftp.us.zyxel.com	ZyXEL Communications Inc. 1130 N. Miller St. Anaheim CA 92806-2001 U.S.A.
	sales@zyxel.com	+1-714-632-0858		
NORWAY	support@zyxel.no	+47 22 80 61 80	www.zyxel.no	ZyXEL Communications A/S Nils Hansens vei 13 0667 Oslo Norway
	sales@zyxel.no	+47 22 80 61 81		
POLAND	info@pl.zyxel.com	+48-22-5286603	www.pl.zyxel.com/	ZyXEL Communications

¹ “+” is the (prefix) number you enter to make an international telephone call.

METHOD LOCATION	SUPPORT E-MAIL	TELEPHONE ¹	WEB SITE	REGULAR MAIL
	SALES E-MAIL	FAX	FTP SITE	
		+48-22-5206701		ul.Emilli Plater 53 00-113 Warszawa Poland
RUSSIA	http://zyxel.ru/support	+7-095-542-89-29	www.zyxel.ru/	ZyXEL Russia Ostrovityanova 37a Str. Moscow, 117279 Russia
	sales@zyxel.ru	+7-095-542-89-25		
SPAIN	support@zyxel.es	+34 902 195 420	www.zyxel.es	ZyXEL Communications Alejandro Villegas 33 1º, 28043 Madrid Spain
	sales@zyxel.es	+34 913 005 345		
SWEDEN	support@zyxel.se	+46 31 744 7700	www.zyxel.se	ZyXEL Communications A/S Sjöporten 4, 41764 Göteborg Sweden
	sales@zyxel.se	+46 31 744 7701		
UKRAINE	support@ua.zyxel.com	+380-44-247-69-78	www.ua.zyxel.com/	ZyXEL Ukraine 13, Pimonenko Str. Kiev, 04050 Ukraine
	sales@ua.zyxel.com	+380-44-494-49-32		
UNITED KINGDOM	support@zyxel.co.uk	+44 (0) 1344 303044 08707 555779 (UK only)	www.zyxel.co.uk	ZyXEL Communications UK Ltd., 11, The Courtyard, Eastern Road, Bracknell, Berkshire, RG12 2XB, United Kingdom (UK)
	sales@zyxel.co.uk	+44 (0) 1344 303034	ftp.zyxel.co.uk	

Table of Contents

Copyright.....	ii
Interference Statements and Warnings	iii
Safety Warnings.....	v
ZyXEL Limited Warranty	vi
Customer Support.....	vii
List of Figures.....	xv
List of Tables	xix
Preface	xxi
Getting Started.....	I
<i>Chapter 1 Getting to Know Your ZyAIR</i>	<i>1-1</i>
1.1 Introducing the ZyAIR.....	1-1
1.2 Features.....	1-1
1.3 Applications	1-4
1.3.1 Internet Access for LAN Networks	1-4
1.3.2 Internet Access in Public Areas	1-5
<i>Chapter 2 The Web Configurator</i>	<i>2-1</i>
2.1 Introducing the Web Configurator	2-1
2.2 Accessing the Web Configurator	2-1
2.3 Wizard Setup Screens	2-2
2.4 Navigating the Web Configurator	2-2
2.5 Screens Overview	2-3
2.6 Login Accounts.....	2-6
2.6.1 Changing Login Account Usernames and Passwords.....	2-7
2.7 Methods of Restoring Factory-Defaults.....	2-9
2.7.1 Using the Reset Button to Restore Factory-Defaults	2-9
2.7.2 Using the Web Configurator to Restore Factory-Defaults.....	2-10
2.8 Restarting the ZyAIR.....	2-11
2.9 Logging Out of the Web Configurator.....	2-11
<i>Chapter 3 General System Setup</i>	<i>3-1</i>
3.1 General System Setup	3-1
3.2 System Name	3-1
3.3 Domain Name	3-1
3.4 iPnP	3-1

3.4.1	How iPnP Works.....	3-2
3.5	General System Settings	3-2
<i>Chapter 4 WAN, LAN and Server Setup</i>		<i>4-1</i>
4.1	Factory Ethernet Defaults	4-1
4.2	LANs and WANs.....	4-1
4.3	IP Address Assignment.....	4-1
4.4	DHCP Configuration	4-1
4.4.1	IP Address and Subnet Mask	4-1
4.4.2	Private IP Addresses	4-2
4.5	DNS Server Address.....	4-2
4.6	PPPoE.....	4-2
4.6.1	PPP MTU	4-3
4.6.2	TCP MSS	4-3
4.7	PPTP.....	4-3
4.8	Configuring the WAN and LAN Settings.....	4-3
4.9	Server Configuration	4-6
Subscriber Account Management.....		II
<i>Chapter 5 Authentication.....</i>		<i>5-1</i>
5.1	About the Built-in Authentication	5-1
5.2	Authentication Settings.....	5-1
<i>Chapter 6 RADIUS.....</i>		<i>6-1</i>
6.1	About RADIUS	6-1
6.2	RADIUS Settings.....	6-1
<i>Chapter 7 Billing.....</i>		<i>7-1</i>
7.1	About the Built-in Billing.....	7-1
7.1.1	Accumulation Accounting Method.....	7-1
7.1.2	Time-to-finish Accounting Method	7-1
7.2	Billing Settings	7-1
<i>Chapter 8 Accounting.....</i>		<i>8-1</i>
8.1	About Subscriber Accounts	8-1
8.2	Discount Price Plan.....	8-1
8.2.1	Charge by Levels	8-1
8.3	Accounting Settings.....	8-1
8.3.1	Charge By Levels Example.....	8-4
8.4	Creating Accounts	8-5
8.4.1	Creating Accounts in the Web Configurator.....	8-5
8.4.2	Using an Exclusive Printer to Create and Print Subscriber Statements	8-7
8.5	Viewing the Account List.....	8-7
<i>Chapter 9 Credit Card.....</i>		<i>9-1</i>
9.1	About the Credit Card Screen.....	9-1
9.2	Credit Card Settings.....	9-1
Advanced Subscriber Account Management.....		III

<i>Chapter 10 Keypad</i>	10-1
10.1 About the Keypad	10-1
10.2 Keypad Settings	10-1
10.3 Keypad Configuration Examples	10-2
10.3.1 Keypad with Pre-Paid Billing Example	10-2
10.3.2 Keypad with Post-Paid Billing Example	10-4
<i>Chapter 11 Customization</i>	11-1
11.1 About the Customization Screens	11-1
11.2 About the Login Page Screen	11-1
11.3 Customizing the Subscriber Login Screen	11-1
11.3.1 Standard Subscriber Login Screen	11-2
11.3.2 Redirect Subscriber Login Screen	11-4
11.3.3 Advanced Subscriber Login Screen	11-5
11.3.4 Framed Subscriber Login Screen	11-7
11.4 Adding a Logo	11-8
11.5 About the Information Windows	11-9
11.5.1 Customizing the Information Windows	11-9
11.6 About the Account Printout	11-12
11.6.1 Customizing the Account Printout	11-12
11.7 Customizing the Credit Card	11-17
11.7.1 Credit Card Standard Login Page	11-17
11.7.2 Credit Card Service Selection Page	11-18
11.7.3 Credit Card Successful Page	11-21
11.7.4 Credit Card Fail Page	11-23
<i>Chapter 12 Pass Through</i>	12-1
12.1 About the Pass Through	12-1
12.2 Configuring Pass Through	12-1
<i>Chapter 13 Filtering</i>	13-1
13.1 About Filtering	13-1
13.2 Configuring Filtering	13-1
<i>Chapter 14 Share</i>	14-1
14.1 About Share	14-1
14.2 Configuring Share	14-1
Advanced Subscriber Account Management 2	IV
<i>Chapter 15 Portal Page, Advertisement Links and Walled Garden</i>	15-1
15.1 Portal Page Advertisement Links and Walled Garden Overview	15-1
15.2 Portal Page	15-1
15.3 Advertisement Links	15-1
15.4 Walled Garden	15-2
15.4.1 Walled Garden Login Example	15-3
<i>Chapter 16 DDNS</i>	16-1
16.1 About DDNS	16-1
16.1.1 DYNDNS Wildcard	16-1

16.2	Configuring DDNS	16-1
<i>Chapter 17 LAN Devices</i>		<i>17-1</i>
17.1	LAN Devices and NAT Overview	17-1
17.1.1	Port Mapping	17-1
17.2	Configuring LAN Devices Port Mapping	17-1
17.2.1	LAN Device Management Example	17-3
17.2.2	Specifying an Inside Server Example	17-4
<i>Chapter 18 Syslog</i>		<i>18-1</i>
18.1	Syslog Configuration	18-1
18.2	Syslog Log Settings Configuration	18-2
<i>Chapter 19 Session Trace</i>		<i>19-1</i>
19.1	Session Trace	19-1
19.2	Session Trace Configuration	19-1
19.3	Session Trace Filename Convention	19-2
<i>Chapter 20 Bandwidth</i>		<i>20-1</i>
20.1	Bandwidth	20-1
20.2	Bandwidth Configuration	20-1
<i>Chapter 21 Wireless LAN</i>		<i>21-1</i>
21.1	Wireless LAN Overview	21-1
21.1.1	IBSS	21-1
21.1.2	BSS	21-1
21.1.3	ESS	21-2
21.2	Wireless LAN Basics	21-2
21.2.1	Wireless Standards	21-2
21.2.2	Wireless LAN Coverage	21-3
21.2.3	Channel	21-3
21.2.4	Introduction to WPA	21-3
21.2.5	WEP Encryption	21-3
21.2.6	RTS/CTS	21-4
21.2.7	Fragmentation Threshold	21-5
21.3	Wireless LAN Setup	21-5
System Status, System Tools and Troubleshooting.....		V
<i>Chapter 22 System Status</i>		<i>22-1</i>
22.1	About System Status	22-1
22.2	View System Information	22-1
22.3	Account List	22-4
22.4	Account Log	22-4
22.5	Current Users	22-6
22.6	DHCP Clients	22-6
22.7	Session List	22-7
22.8	LAN Devices	22-9
22.8.1	Accessing a LAN Device	22-9

<i>Chapter 23 Configuration, Firmware and Accounting Log Maintenance</i>	23-1
23.1 Filename Conventions.....	23-1
23.2 Configuration File Maintenance	23-1
23.2.1 Backup Configuration Using HTTP	23-1
23.2.2 Backup Configuration Using TFTP	23-3
23.2.3 Restore Configuration Using HTTP	23-4
23.2.4 Restore Configuration Using TFTP	23-5
23.3 Firmware Upgrade	23-5
23.3.1 Manual Firmware Upgrade Using the Web Configurator	23-6
23.3.2 Manual Firmware Upgrade via TFTP Server	23-7
23.3.3 Manual Boot Code Upgrade Using the Web Configurator.....	23-8
23.3.4 Scheduled Firmware Upgrade.....	23-9
<i>Chapter 24 SSL (Secure Socket Layer) Security</i>	24-1
24.1 About SSL.....	24-1
24.2 Activating SSL Security for Management Connections	24-1
24.3 Viewing and Installing the SSL Security Certificate	24-2
24.4 Activating SSL Security for Subscriber Logins	24-6
24.5 SSL Certificate Download	24-6
<i>Chapter 25 Ping Command</i>	25-1
25.1 About Ping Command.....	25-1
25.2 Using Ping Command	25-1
<i>Chapter 26 Restart</i>	26-1
26.1 Restart	26-1
<i>Chapter 27 Troubleshooting</i>	27-1
27.1 Using LEDs to Diagnose Problems.....	27-1
27.1.1 The Power LED	27-1
27.1.2 The LAN Port LEDs	27-1
27.1.3 The WAN Port LED	27-1
27.2 Web Configurator	27-1
27.3 Internet Access.....	27-2
27.4 Statement Printer.....	27-3
Additional Information	VI
<i>Appendix A. Setting up Your Computer's IP Address</i>	<i>A</i>
<i>Appendix B. IP Address Assignment Conflicts</i>	<i>J</i>
<i>Appendix C. Wireless LAN and IEEE 802.11</i>	<i>L</i>
<i>Appendix D. General Antenna Information</i>	<i>O</i>
<i>Appendix E. PPPoE</i>	<i>Q</i>
<i>Appendix F. PPTP</i>	<i>S</i>
<i>Appendix G. IP Subnetting</i>	<i>V</i>
<i>Appendix H. Subscriber Login</i>	<i>BB</i>
<i>Appendix I. Power and Cable Specifications</i>	<i>CC</i>

Appendix J. Report Printing Using the SP-200 GG

Index **39**

List of Figures

Figure 1-1 Application: Internet Access for LAN Networks	1-5
Figure 1-2 Application: Internet Access in Public Areas.....	1-5
Figure 2-1 Entering ZyAIR IP Address in Internet Explorer.....	2-1
Figure 2-2 Web Configurator: Login.....	2-2
Figure 2-3 Web Configurator Navigation.....	2-3
Figure 2-4 WIZARD Submenu.....	2-3
Figure 2-5 Quick View	2-5
Figure 2-6 SYSTEM TOOLS: SYSTEM ACCOUNT	2-8
Figure 2-7 Side Panel.....	2-10
Figure 2-8 Reset to Default Settings.....	2-10
Figure 2-9 Restart	2-11
Figure 2-10 Logging Out	2-11
Figure 3-1 SYSTEM.....	3-3
Figure 4-1 WAN/LAN.....	4-4
Figure 4-2 SERVER.....	4-7
Figure 5-1 AUTHENTICATION.....	5-1
Figure 5-2 Redirect Page Sample Code	5-3
Figure 6-1 RADIUS.....	6-2
Figure 7-1 BILLING.....	7-2
Figure 8-1 ACCOUNTING	8-2
Figure 8-2 Charge By Levels Example.....	8-4
Figure 8-3 Account Generator Panel	8-5
Figure 8-4 Web-based Account Generator Printout Preview Example.....	8-6
Figure 8-5 Web-based PC-connected Printout Preview Example.....	8-6
Figure 8-6 Account List.....	8-7
Figure 9-1 CREDIT CARD	9-1
Figure 10-1 KEYPAD.....	10-1
Figure 10-2 Select Pre-Paid Billing	10-2
Figure 10-3 Define Pre-Paid Billing Profiles.....	10-3
Figure 10-4 Billing Profiles 1 and 2 Examples	10-3
Figure 10-5 Select Post-Paid Billing.....	10-4
Figure 10-6 Define Post-Paid Billing Plan.....	10-4
Figure 10-7 Post-Paid Account Printout Example	10-5
Figure 10-8 Post-Paid Account Bill Printout Example	10-5
Figure 11-1 Customization	11-2
Figure 11-2 Login Page: Standard	11-3
Figure 11-3 Login Page Example: Standard	11-4
Figure 11-4 Login Page: Redirect.....	11-4
Figure 11-5 Login Page: Redirect Code.....	11-5
Figure 11-6 Login Page: Advanced	11-6
Figure 11-7 Login Page: Color Grid.....	11-7
Figure 11-8 Subscriber Login Screen Example: Advanced	11-7
Figure 11-9 Subscriber Login Screen: Frame	11-8
Figure 11-10 Subscriber Login Screen Example: Frame	11-8
Figure 11-11 Logo	11-9
Figure 11-12 Customization: Information Windows	11-10
Figure 11-13 Account Printout	11-12
Figure 11-14 Preview of PC-connected Printer Example	11-14
Figure 11-15 Preview of Account Generator Printer Example	11-15
Figure 11-16 Preview of Post-Paid Printout Example	11-16
Figure 11-17 Credit Card: Standard Login Page.....	11-16
Figure 11-18 Credit Card Standard Login Page Example.....	11-17

Figure 11-19 Credit Card Service Selection Page	11-18
Figure 11-20 Credit Card Service Selection Page Preview	11-20
Figure 11-21 Credit Card Successful Page	11-21
Figure 11-22 Credit Card Successful Page Preview	11-22
Figure 11-23 Credit Card Service Fail Page	11-22
Figure 11-24 Credit Card Failed Page Preview	11-23
Figure 12-1 PASS THROUGH	12-2
Figure 13-1 FILTERING	13-1
Figure 14-1 SHARE	14-1
Figure 15-1 PORTAL PAGE	15-1
Figure 15-2 ADVERTISEMENT	15-2
Figure 15-3 WALLED GARDEN	15-3
Figure 15-4 Walled Garden Login Example	15-4
Figure 16-1 DDNS	16-2
Figure 17-1 LAN DEVICES	17-2
Figure 17-2 LAN Device Remote Management Example 1	17-3
Figure 17-3 LAN Devices: Example 1	17-3
Figure 17-4 LAN Device Remote Management Example 2	17-4
Figure 17-5 LAN Devices: Example 2	17-4
Figure 18-1 Syslog	18-1
Figure 18-2 Log Settings	18-3
Figure 19-1 SESSION TRACE	19-1
Figure 19-2 Session Trace Information Example	19-2
Figure 20-1 BANDWIDTH	20-1
Figure 21-1 IBSS (Ad-hoc) Wireless LAN	21-1
Figure 21-2 Basic Service set	21-1
Figure 21-3 Extended Service Set	21-2
Figure 21-4 RTS/CTS	21-4
Figure 21-5 WIRELESS	21-6
Figure 22-1 SYSTEM	22-2
Figure 22-2 ACCOUNT LOG	22-5
Figure 22-3 CURRENT USER	22-6
Figure 22-4 DHCP CLIENTS	22-7
Figure 22-5 SESSION LIST	22-8
Figure 22-6 LAN DEVICES	22-9
Figure 23-1 CONFIGURATION: Backup Using HTTP	23-2
Figure 23-2 Configuration Backup: File Download	23-2
Figure 23-3 Configuration Backup: Save As	23-3
Figure 23-4 CONFIGURATION: Backup Using TFTP	23-3
Figure 23-5 Configuration Backup: Using TFTP Successful	23-4
Figure 23-6 CONFIGURATION: Restore Using HTTP	23-4
Figure 23-7 CONFIGURATION: Restore Using TFTP	23-5
Figure 23-8 Manual Firmware Upgrade Using the Web Configurator	23-6
Figure 23-9 System Restart	23-7
Figure 23-10 Manual Firmware Upgrade via TFTP Server	23-7
Figure 23-11 Manual Boot Code Upgrade Using the Web Configurator	23-8
Figure 23-12 System Restart	23-8
Figure 23-13 Scheduled Firmware Upgrade	23-9
Figure 23-14 Synchronization Check File Example	23-10
Figure 24-1 System Settings: Server Configuration: Enable SSL Security	24-1
Figure 24-2 Installing the SSL Security Certificate: First Security Alert	24-2
Figure 24-3 Installing the SSL Security Certificate: Second Security Alert	24-2
Figure 24-4 Installing the SSL Security Certificate: View Certificate	24-3
Figure 24-5 Installing the SSL Security Certificate: Certificate Import Wizard	24-3
Figure 24-6 Certificate Import Wizard: Location	24-4
Figure 24-7 Certificate Import Wizard: Finish	24-4

Figure 24-8 Root Certificate Store..... 24-4
Figure 24-9 Certificate Import Wizard 24-5
Figure 24-10 Certificate: Details..... 24-5
Figure 24-11 Security Alert: Trusted..... 24-5
Figure 24-12 AUTHENTICATION: Activate SSL Login..... 24-6
Figure 24-13 SSL CERTIFICATE 24-7

List of Tables

Table 2-1 Web Configurator Screens Overview	2-4
Table 2-2 Quick View	2-5
Table 2-3 SYSTEM TOOLS: SYSTEM ACCOUNT	2-8
Table 2-4 Reset to Default Settings	2-11
Table 3-1 SYSTEM	3-4
Table 4-1 WAN/LAN	4-4
Table 4-2 SERVER	4-7
Table 5-1 AUTHENTICATION	5-1
Table 6-1 RADIUS	6-3
Table 7-1 BILLING	7-2
Table 8-1 ACCOUNTING	8-3
Table 8-2 Charge By Levels Example	8-5
Table 8-3 Account List	8-7
Table 9-1 CREDIT CARD	9-2
Table 10-1 KEYPAD	10-2
Table 11-1 Login Page: Standard	11-3
Table 11-2 Login Page: Redirect	11-4
Table 11-3 Login Page: Advanced	11-6
Table 11-4 Subscriber Login Screen: Frame	11-8
Table 11-5 Logo	11-9
Table 11-6 Customization: Information Windows	11-10
Table 11-7 Account Printout	11-13
Table 11-8 Credit Card: Standard Login Page	11-17
Table 11-9 Credit Card Service Selection Page	11-19
Table 11-10 Credit Card Successful Page	11-21
Table 11-11 Credit Card Service Fail Page	11-22
Table 12-1 PASS THROUGH	12-2
Table 13-1 FILTERING	13-2
Table 14-1 SHARE	14-1
Table 15-1 PORTAL PAGE	15-1
Table 15-2 ADVERTISEMENT	15-2
Table 15-3 WALLED GARDEN	15-3
Table 16-1 DDNS	16-2
Table 17-1 LAN DEVICES	17-2
Table 18-1 Syslog	18-1
Table 18-2 Log Settings	18-3
Table 18-3 Log Formats	18-4
Table 19-1 SESSION TRACE	19-2
Table 19-2 Session Trace File Fields	19-3
Table 20-1 BANDWIDTH	20-2
Table 21-1 IEEE 802.11b Data Rates and Modulation	21-2
Table 21-2 IEEE 802.11g Data Rates and Modulation	21-3
Table 21-3 Wireless LAN Coverage	21-3
Table 21-4 WIRELESS	21-7
Table 22-1 System	22-3
Table 22-2 ACCOUNT LOG	22-5
Table 22-3 CURRENT USER	22-6
Table 22-4 DHCP CLIENTS	22-7
Table 22-5 SESSION LIST	22-8
Table 22-6 LAN DEVICES	22-9
Table 23-1 Scheduled Firmware Upgrade	23-10
Table 24-1 SSL CERTIFICATE	24-7

Table 25-1 PING COMMAND	25-1
Table 27-1 Troubleshooting Power LED.....	27-1
Table 27-2 Troubleshooting LAN LEDs.....	27-1
Table 27-3 Troubleshooting WAN LEDs.....	27-1
Table 27-4 Troubleshooting the Web Configurator.....	27-2
Table 27-5 Troubleshooting the Internet Browser Display	27-2
Table 27-6 Troubleshooting Internet Access.....	27-2
Table 27-7 Troubleshooting a Statement Printer	27-3

Preface

Congratulations on your purchase of the ZyXEL ZyAIR G-4100 Hot Spot Gateway.

The ZyAIR Hot Spot Gateway combines an IEEE 802.11b wireless access point, router, 4-port switch and service gateway in one box. If you have an “exclusive printer”, you can connect it directly to the ZyAIR, allowing you to easily print subscriber statements. The ZyAIR is ideal for offices, coffee shops, libraries, hotels and airport terminals catering to subscribers that seek Internet access. You should have an Internet account already set up and have been given usernames, passwords etc. required for Internet access.

This user's guide is designed to guide you through the configuration of your ZyAIR using the web configurator.



Register your product online to receive e-mail notices of firmware upgrades and information at www.zyxel.com for global products or at www.us.zyxel.com for North American products.

Related Documentation

- Supporting Disk
Refer to the included CD for support documents.
- Quick Start Guide
The Quick Start Guide is designed to help you get up and running right away. It contains information on the hardware connections and installation.
- ZyXEL Web Site
The ZyXEL download library at www.zyxel.com contains additional support documentation. Please also refer to www.zyxel.com for an online glossary of networking terms.











User Guide Feedback

Help us help you. E-mail all User Guide-related comments, questions or suggestions for improvement to techwriters@zyxel.com.tw or send regular mail to The Technical Writing Team, ZyXEL Communications Corp., 6 Innovation Road II, Science-Based Industrial Park, Hsinchu, 300, Taiwan. Thank you.

Syntax Conventions

- “Enter” means for you to type one or more characters (and press the carriage return). “Select” or “Choose” means for you to use one of the predefined choices.
- Mouse action sequences are denoted by commas. For example, “In Windows, click **Start**, **Settings**, **Control Panel**” means first click the **Start** button, then put your mouse on **Programs**, and finally select **Control Panel**.
- “e.g.” is a shorthand for “for instance”, and “i.e.” means “that is” or “in other words”.
- The ZyXEL ZyAIR G-4100 Hot Spot Gateway may be referred to as the “ZyAIR” in this manual.
- The ZyXEL ZyAIR SP-200 Statement Printer may be referred to as the “SP-200”, “statement printer”, “three-button printer” or “exclusive printer” in this manual.

Graphics Icons Key

 ZyAIR	 Statement Printer	 Notebook Computer
 Server	 Computer	 Broadband Modem or Router
 Wireless Signal	 Switch	 Router
 DSLAM (Digital Subscriber Line Access Multiplexer)		

Part I:

Getting Started

This part introduces the ZyAIR, the web configurator and general system setup.

Chapter 1

Getting to Know Your ZyAIR

This chapter introduces the features and applications of the ZyAIR.

1.1 Introducing the ZyAIR

The ZyAIR Hot Spot Gateway combines an IEEE 802.11g wireless access point, router, 4-port switch and service gateway in one box. If you have an “exclusive printer”, you can connect it directly to the ZyAIR, allowing you to easily print subscriber statements. The ZyAIR is ideal for offices, coffee shops, libraries, hotels and airport terminals catering to subscribers that seek Internet access. You should have an Internet account already set up and have been given usernames, passwords etc. required for Internet access.

1.2 Features

Your ZyAIR provides the following features to accommodate subscribers with a variety of network configurations with little or no technical support.

iPnP

The IP Plug and Play feature allows a computer to access the Internet or the ZyAIR without changing the network settings (such as IP address and subnet mask) of the computer, even when the IP addresses of the computer and the ZyAIR are not in the same subnet.

WEP Data Encryption

WEP (Wired Equivalent Privacy) encrypts data frames before transmitting over the wireless network to help keep network communications private. The ZyAIR uses 64-bit or 128-bit WEP encryption.

WPA Data Encryption

Wi-Fi Protected Access (WPA) encrypts data frames before transmitting over the wireless network to help keep network communications private. WPA provides user authentication and better data encryption than WEP.

VPN (Virtual Private Network) Pass Through

The ZyAIR allows subscribers to create VPN networks (which use data encryption and the Internet to provide secure communications) that go through the ZyAIR.

VLAN

The ZyAIR uses port-based VLAN (Virtual Local Area Network) on the LAN Ethernet ports to block direct communications between subscribers. This is called layer 2 isolation.

SSL Secure Login

With Secure Socket Layer (SSL) activated upon login, data exchanged between the ZyAIR and client computers are encrypted and protected.

PPTP Support

Point-to-Point Tunneling Protocol (PPTP) is a network protocol that enables secure transfer of data from a remote client to a private server, creating a Virtual Private Network (VPN) using a TCP/IP-based network. PPTP supports on-demand, multi-protocol and virtual private networking over public networks, such as the Internet. Use PPTP to connect to a broadband modem to achieve access to high-speed data networks via a familiar "dial-up networking" user interface.

PPPoE Support (RFC2516)

PPPoE (Point-to-Point Protocol over Ethernet) emulates a dial-up connection. It allows your ISP to use their existing network configuration with newer broadband technologies such as ADSL. The PPPoE driver on the ZyAIR is transparent to the computers on the LAN, which see only Ethernet and are not aware of PPPoE thus saving you from having to manage PPPoE clients on individual computers.

Network Address Translation (NAT)

NAT (Network Address Translation - NAT, RFC 1631) allows the translations of multiple IP addresses used within one network to different IP addresses known within another network.

DHCP Support

DHCP (Dynamic Host Configuration Protocol) allows the individual computers (DHCP clients) to obtain TCP/IP configuration at start-up from a centralized DHCP server. The ZyAIR has built-in DHCP server capability. It can assign IP addresses, an IP default gateway and DNS servers to DHCP clients. The ZyAIR can also act as a surrogate DHCP server (DHCP Relay) where it relays IP address assignment from the actual real DHCP server to the DHCP clients.

E-mail Forwarding

The ZyAIR is able to forward and retrieve e-mail messages when the subscriber's default email server is down or behind a firewall.

DNS Proxy

With DNS proxy, the ZyAIR provides DNS redirection when a subscriber's configured DNS server is behind a firewall or located in a private Intranet.

Local Subscriber Database

The ZyAIR allows you to maintain a subscriber database on the ZyAIR without setting up an external RADIUS server. Subscriber accounting and authentication are done using the local subscriber database.

RADIUS

The ZyAIR can use an external RADIUS (Remote Authentication Dial In User Service defined in RFC2138 and 2139) server for subscriber authentication and accounting.

Accounting

The ZyAIR has a built-in accounting feature for keeping track of subscriber Internet usage time.

iPass

The iPass company provides connectivity services for mobile Internet users. The ZyAIR can authenticate iPass clients through an external RADIUS server that is Wi-Fi based Wireless Internet Service Provider roaming (WISPr) compliant.

Local Content and Advertising Links

Once connected to the network, the ZyAIR directs the subscriber to a specified web site and display advertisement links. This can be a source of extra online advertising revenues and increased business exposure.

Access Control (Walled Garden)

With the walled garden feature, subscribers are able to access predetermined web sites without logging in. The ZyAIR blocks full Internet access until the subscribers log in.

Subscriber Login Page Customization

You can customize the subscriber login page according to your business needs. The advanced settings allow you to include welcome messages, company logo and basic formatting.

Web Configurator Management

The ZyAIR comes with an embedded web-based configurator. It offers advanced management features and allows you to manage the ZyAIR remotely using Internet Explorer.

SNMP

SNMP (Simple Network Management Protocol) is a protocol used for exchanging management information between network devices. SNMP is a member of the TCP/IP protocol suite. Your ZyAIR supports SNMP agent functionality, which allows a manager station to manage and monitor the ZyAIR through the network. The ZyAIR supports SNMP version 2c (SNMPv2c).

Watchdog

The ZyAIR can continue working by resetting itself after a system crash.

Upgrade Firmware

The firmware of the ZyAIR can be upgraded via the web configurator.

Syslog

The ZyAIR's syslog function allows network administrators to monitor the usage status of subscribers from a remote site. You can set up a syslog server to receive the log of information on current logged-in subscribers that the ZyAIR sends periodically.

IEEE 802.11g Wireless LAN Standard

The ZyAIR complies with the IEEE 802.11g wireless standard, which supports data speeds of up to 54 Mbps.

IEEE 802.11b Wireless LAN Standard

The ZyAIR is also fully compatible with the 802.11b standard. This means an IEEE 802.11b radio card can interface directly with the ZyAIR (and vice versa) at 11 Mbps or lower depending on range.

Antennas

The ZyAIR is equipped with two reverse SMA connectors and two detachable omni-directional 2dBi antennas to provide a clear radio signal between the wireless stations and the access points. Refer to the *Antennas* appendix for more information.

4-Port Switch

A combination of switch and Internet gateway makes your ZyAIR a cost-effective and viable network solution. You can connect up to four computers to the LAN ports on the ZyAIR without the cost of a hub. To connect more than four Ethernet devices, attach a hub or switch.

10/100M Auto-negotiating Ethernet/Fast Ethernet Interface

This auto-negotiating feature allows the ZyAIR to detect the speed of incoming transmissions and adjust appropriately without manual intervention. It allows data transfer of either 10 Mbps or 100 Mbps in either half-duplex or full-duplex mode depending on your Ethernet network.

Reset Button

Use the reset button to restore the ZyAIR back to its factory defaults.

Statement Printer

A statement printer allows you to generate subscriber accounts on the ZyAIR and print out the account information on-site without using a computer.

The statement printer is also known as an “account generator”, “three-button printer” or “exclusive printer”.

Ease of Installation

Your ZyAIR is designed for quick, intuitive and easy installation. It can be mounted on a desktop or a wall.

1.3 Applications

The following sections describe network application examples in which the ZyAIR is used. ¹

1.3.1 Internet Access for LAN Networks

With a broadband modem or router (A), the ZyAIR allows the attached computers to enjoy high speed Internet access.

¹ The total number of concurrent WLAN users allowed is 24. The total number of concurrent users (WLAN and Wired) allowed is 100

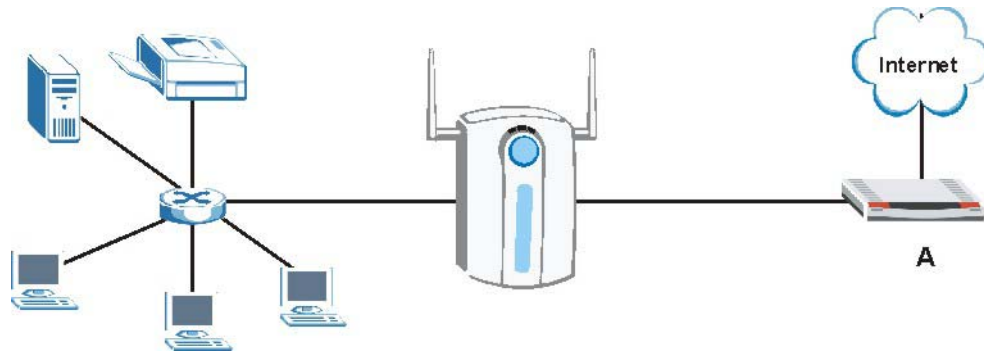

Figure 1-1 Application: Internet Access for LAN Networks

1.3.2 Internet Access in Public Areas

In public areas, such as a hotel, the ZyAIR provides high speed Internet access to subscribers. Account billing and authentication can be done using a statement printer (B) and the built-in billing function and local subscriber database.

The ZyAIR functions as an access point (AP) to bridge the wired and the wireless network allowing wireless stations to access the Internet through the ZyAIR.

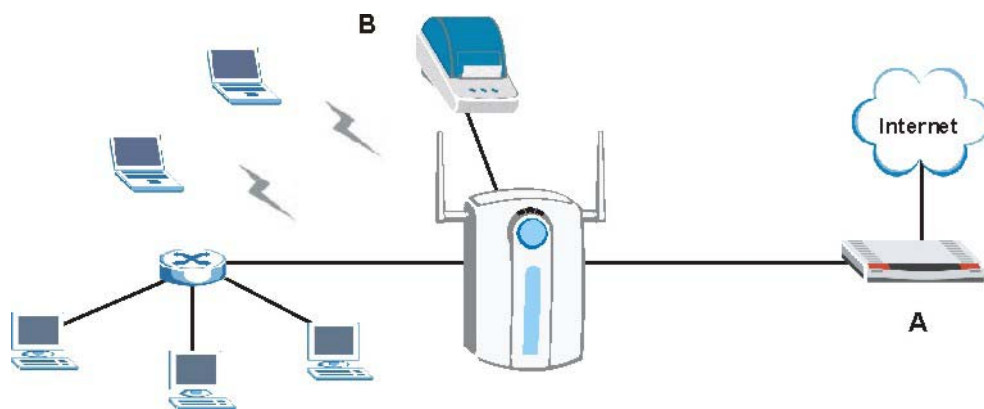

Figure 1-2 Application: Internet Access in Public Areas

Chapter 2

The Web Configurator

This chapter introduces how to access the web configurator to perform general system configuration.

2.1 Introducing the Web Configurator

The web configurator is best viewed with Internet Explorer (version 4.0 or above) or Netscape Navigator (version 6.0 or above). Your browser must have JavaScript support enabled.

2.2 Accessing the Web Configurator

Follow the steps below to access the web configurator.



The ZyAIR allows only one web configurator session at a time.

- Step 1.** Make sure your ZyAIR is properly connected (refer to instructions in the *Quick Start Guide* on hardware installation and connections).
- Step 2.** Launch your web browser and type the WAN or LAN IP address of the ZyAIR as the web address (it is recommended that you connect your computer to the LAN and use the LAN IP address for initial configuration). **192.168.1.1** is the default IP address for the LAN port. If you are using a different port number (between 8000 and 8099) for the web server, you must also append the port number to the LAN IP address separated with a colon “:”, for example, <http://192.168.1.1:8080>.

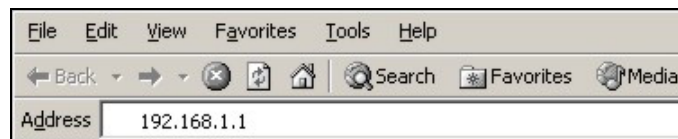

Figure 2-1 Entering ZyAIR IP Address in Internet Explorer

- Step 3.** A login screen displays. Type “admin” (default) as the user name and "1234" (default) as the password and click **Login**.



The user name and password are case sensitive.



Figure 2-2 Web Configurator: Login

Step 4. You should see the first screen of the Wizard Setup. Refer to the *Quick Start Guide* for more information on configuring the Wizard Setup screens.



The ZyAIR automatically logs you out if there is no activity for longer than five minutes after you log in. If this happens, simply log back in again. You can change the time period in the ADVANCED SERVER screen's Administrator Inactivity Timer field.

2.3 Wizard Setup Screens

The Wizard Setup screens display when you first access the ZyAIR. Refer to the *Quick Start Guide* for information on how to configure the Wizard Setup screens.

2.4 Navigating the Web Configurator

After you finish the Wizard Setup screens, you first see the **Quick View** screen after login.



Click the  icon (located in the top right corner of most screens) to view online help.

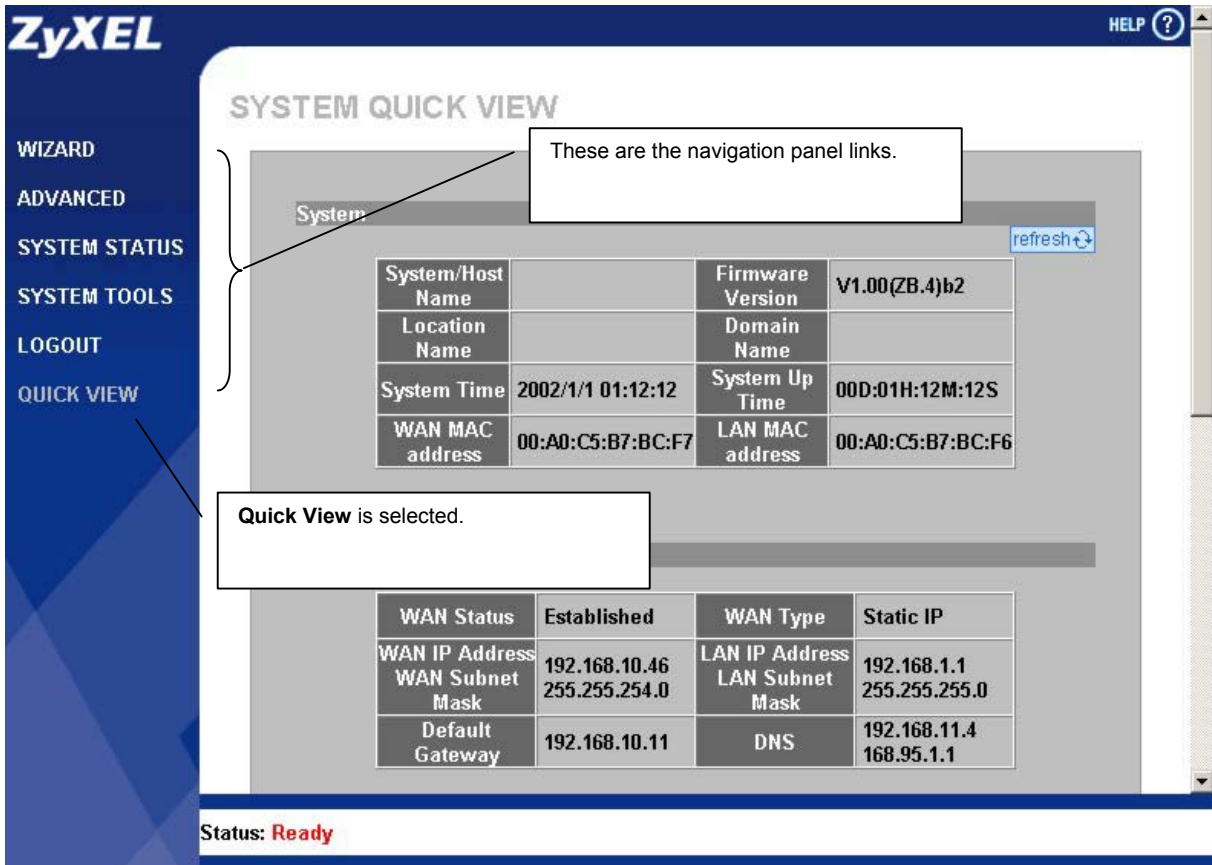

Figure 2-3 Web Configurator Navigation

Click a navigation panel link to open a submenu of links to individual screens. For example, click **WIZARD** to display the following submenu.



Figure 2-4 WIZARD Submenu

2.5 Screens Overview

The following table lists the various web configurator screens.

Table 2-1 Web Configurator Screens Overview

WIZARD	ADVANCED	SYSTEM STATUS	SYSTEM TOOLS
INTERNET	SYSTEM	SYSTEM	CONFIGURATION
WIRELESS	WAN/LAN	ACCOUNT LIST	FIRMWARE
E-MAIL	SERVER	ACCOUNT LOG	Manual Firmware Upgrade
AUTHENTICATION	AUTHENTICATION	CURRENT USER	Scheduled Firmware Upgrade
BILLING	RADIUS	DHCP CLIENT	
PRINTER	BILLING	SESSION LIST	
ACCOUNTING	ACCOUNTING	LAN DEVICES	SYSTEM ACCOUNT
SYSTEM	CREDIT CARD		SSL CERTIFICATE
	KEYPAD		PING COMMAND
	CUSTOMIZATION		RESTART
	Login Page		
	Logo		
	Information Windows		
	Account Printout		
	Credit Card		
	PASS THROUGH		
	FILTERING		
	SHARE		
	PORTAL PAGE		
	ADVERTISEMENT		
	WALLED GARDEN		
	DDNS		
	LAN DEVICES		
	SYSLOG		
	Syslog		
	Log Settings		
	SESSION TRACE		
	BANDWIDTH		
	WIRELESS		

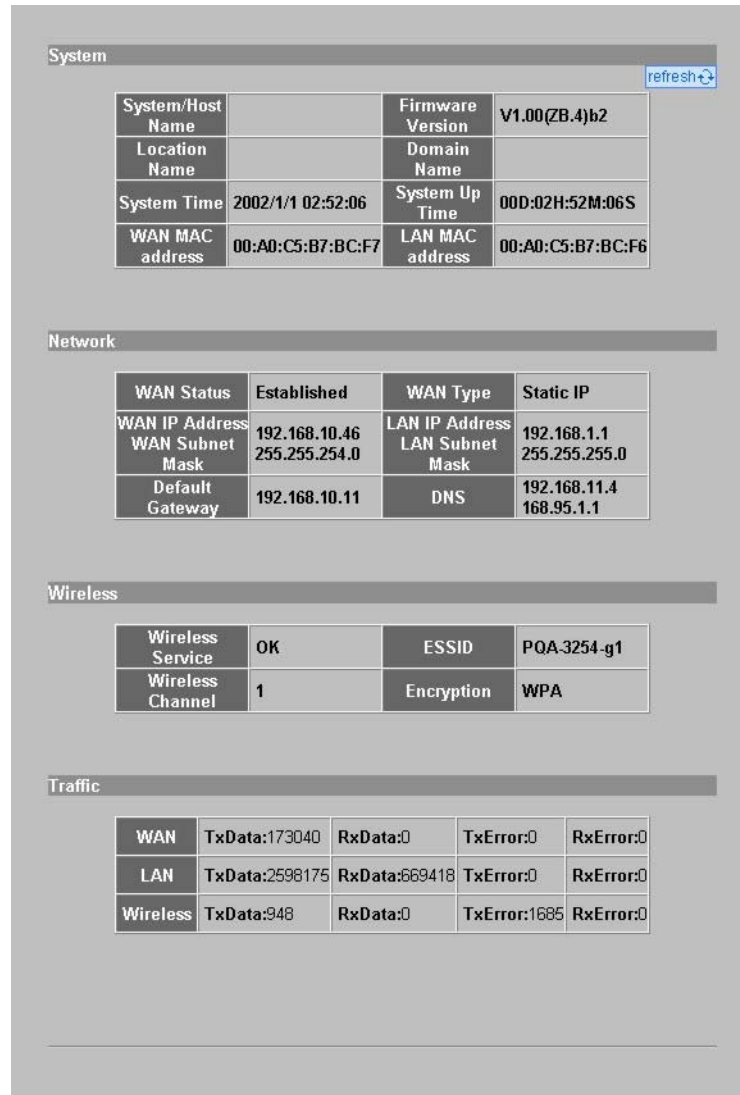

Figure 2-5 Quick View

The following table describes the labels in this screen.

Table 2-2 Quick View

LABEL	DESCRIPTION
System	
Refresh	Click Refresh to update this screen.
System/Host Name	This field displays the description name of the ZyAIR for identification purposes.
Firmware Version	This field displays the version of the firmware on the ZyAIR.
Location Name	This field displays the device's geographical location.
Domain Name	This field displays the domain name of the ZyAIR.
System Time	This field displays the ZyAIR's current time.
System Up Time	This field displays the how long the ZyAIR has been operating since it was last started.

Table 2-2 Quick View

LABEL	DESCRIPTION
WAN MAC Address	This field displays the MAC address of the ZyAIR on the WAN.
LAN MAC Address	This field displays the MAC address of the ZyAIR on the LAN.
Network	
WAN Status	This field displays the status of the ZyAIR's connection to the Internet (Established or Not Established).
WAN Type	This field displays the DHCP mode of the WAN port. It displays DHCP Client , Static IP Setting , PPPoE , or PPTP .
WAN IP Address WAN Subnet Mask	This field displays the IP address and the subnet mask of the WAN port on the ZyAIR.
LAN IP Address LAN Subnet Mask	This field displays the IP address and the subnet mask of the LAN port on the ZyAIR.
Default Gateway	This field displays the IP address of the default gateway of the WAN port on the ZyAIR.
DNS	This field displays the IP address of the DNS server that the ZyAIR is using.
Wireless	
Wireless Service	This field displays the status of the ZyAIR's wireless LAN.
ESSID	This field displays the ZyAIR's Extended Service Set IDentity.
Wireless Channel	This field displays the channel that the ZyAIR is using.
Encryption	This field displays the type of data encryption that the ZyAIR is using. WEP displays if the ZyAIR is using WEP data encryption. WPA displays if ZyAIR is using WPA data encryption. Disable displays if the ZyAIR is not using data encryption.
Traffic	
WAN	This field displays traffic statistics for the ZyAIR's WAN connection.
LAN	This field displays traffic statistics for the ZyAIR's LAN connection.
Wireless	This field displays traffic statistics for the ZyAIR's wireless LAN connection.

2.6 Login Accounts

There are four system accounts that you can use to log in to the ZyAIR: administrator, account manager, supervisor and super subscriber.

The administrator account allows you full access to all system configurations. The default administrator user name is "admin" and the default password is "1234".

The account manager account is used for proprietary subscriber account management only. No system configuration is allowed. This account is useful for front desk personnel (such as in a hotel) for setting up subscriber accounts without tampering with the system configuration. The account manager default user name and password are "account".

With the supervisor account, you can only view the system status and change the supervisor account password. This account is useful for allowing a manager to view the device's status and lists of accounts and logged in subscribers without changing the system configuration. The default supervisor account user name and password is "supervisor".

Use the super subscriber account to test the Internet connection between the ZyAIR and the ISP. The ZyAIR does not impose time limitations or charges on this account. Thus, anyone who logs in with this account is able to gain Internet access for free. The default super subscriber user name and password are “super”.



You can only log in using the super subscriber account in the subscriber login screen.

2.6.1 Changing Login Account Usernames and Passwords



It is recommended you change the account passwords.

Click **SYSTEM TOOLS** and **SYSTEM ACCOUNT**.

SYSTEM ACCOUNT

Administrator Account
 Administrator can fully control this system and modify all settings.

Username:

Password:

Confirm:

Web-based Accounting Operator
 Web-based accounting operator can operate the proprietary web-based accounting system.

Username:

Password:

Confirm:

Supervisor Account
 Supervisor can only view system status and change his password.

Username:

Password:

Confirm:

Super Subscriber Account
 Super subscriber is a built-in subscriber account for system test or premium usage.

Username:

Password:

Confirm:

Figure 2-6 SYSTEM TOOLS: SYSTEM ACCOUNT



The account user names and passwords are case sensitive.

Table 2-3 SYSTEM TOOLS: SYSTEM ACCOUNT

LABEL	DESCRIPTION
Administrator Account	
Username	Enter the user name for the administrative account. The default is admin .
Password	Enter a new administrative account password.
Confirm	Enter the new administrator password again for confirmation.
Web-based Accounting Manager	
Username	Enter the user name for the account manager account. The default is account .
Password	Enter a new account manager password.

Table 2-3 SYSTEM TOOLS: SYSTEM ACCOUNT

LABEL	DESCRIPTION
Confirm	Enter the new account manager password again for confirmation.
Supervisor Account	
Username	Enter the user name for the supervisor account. The default is supervisor .
Password	Enter a new supervisor password.
Confirm	Enter the new supervisor password again for confirmation.
Super Subscriber Account	
 You can only log in using the super subscriber account in the subscriber login screen.	
Username	Enter the user name for the super subscriber account. The default is super .
Password	Enter a new super subscriber account password.
Confirm	Enter the new super subscriber account password again for confirmation.
Apply	Click Apply to save the changes back to the ZyAIR.

2.7 Methods of Restoring Factory-Defaults

There are two methods you can use to erase the current configuration and restore factory defaults.

2.7.1 Using the Reset Button to Restore Factory-Defaults

The reset button is located on the side panel. Use a pointed object to press this button in once to reset the ZyAIR back to the factory defaults.



All of your custom configuration including the local subscriber database will be erased.

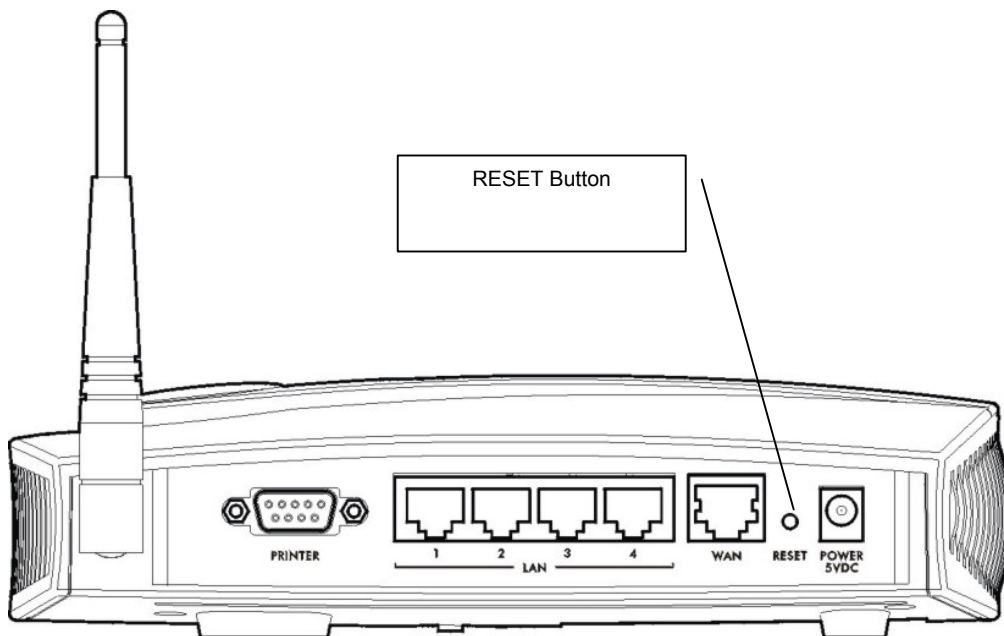

Figure 2-7 Side Panel

2.7.2 Using the Web Configurator to Restore Factory-Defaults

To reset the ZyAIR back to the factory defaults, click **SYSTEM TOOLS** and **CONFIGURATION** to display the screen as shown next.

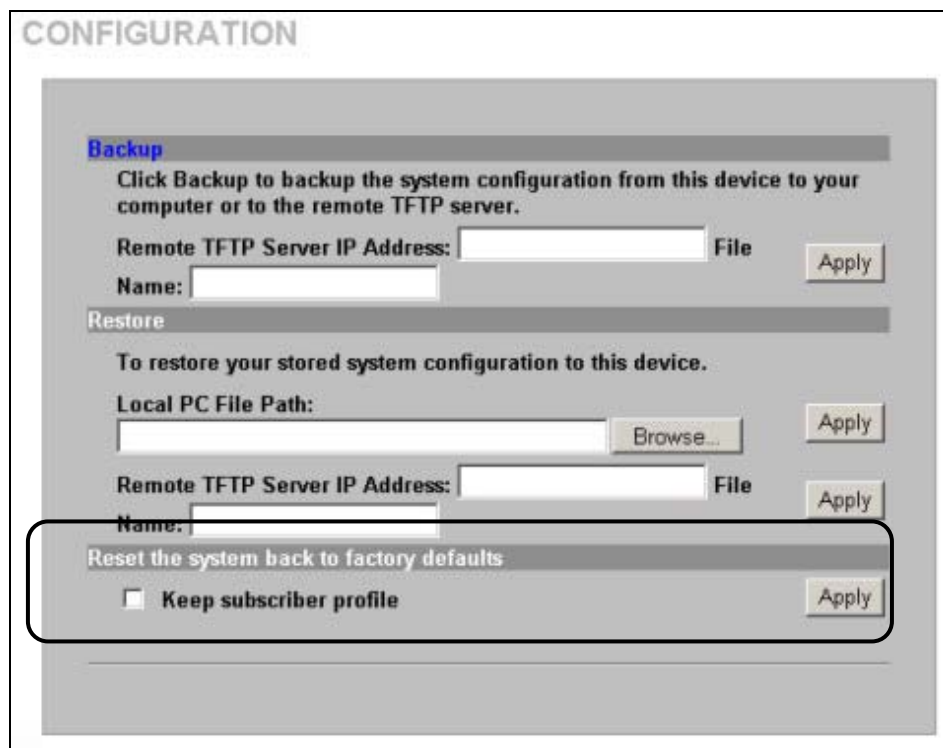

Figure 2-8 Reset to Default Settings

The following table describes the labels in this screen.

Table 2-4 Reset to Default Settings

LABEL	DESCRIPTION
	Reset the system back to factory defaults
Keep subscriber profile	Select this option to reset the system configuration back to the factory default but retain subscriber account information. All other custom configuration is erased.
Apply	Click Apply to reset system configuration back to the factory defaults.

2.8 Restarting the ZyAIR

You *must* restart the ZyAIR every time you change the system IP address or upload a firmware or configuration file.

Click **SYSTEM TOOLS**, **RESTART** and then **Apply**.

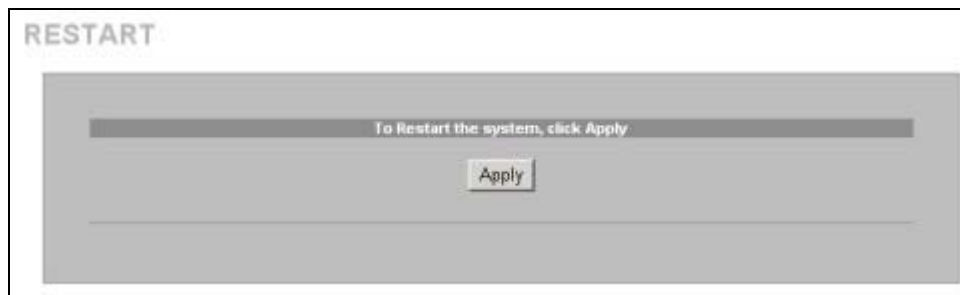

Figure 2-9 Restart



When the ZyAIR restarts, all connections will be terminated. Anyone using a system account will need to log in again. The subscribers may also need to log in again.

2.9 Logging Out of the Web Configurator

Click **LOGOUT** to exit from the web configurator.

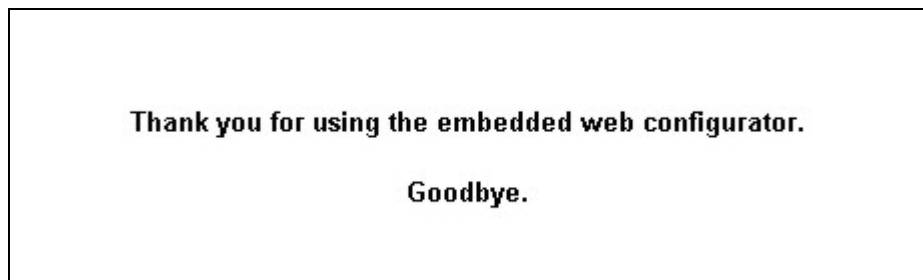

Figure 2-10 Logging Out

Chapter 3

General System Setup

*This chapter describes how to configure the **SYSTEM** advanced setup screens.*

3.1 General System Setup

Use this screen to configure administrative and system-related general settings for your ZyAIR.

3.2 System Name

System Name is for identification purposes. However, because some ISPs check this name you should enter your computer's "Computer Name".

- In Windows 95/98 click **Start, Settings, Control Panel, Network**. Click the Identification tab, note the entry for the **Computer Name** field and enter it as the **System Name**.
- In Windows 2000, click **Start, Settings and Control Panel** and then double-click **System**. Click the **Network Identification** tab and then the **Properties** button. Note the entry for the **Computer name** field and enter it as the **System Name**.
- In Windows XP, click **Start, My Computer, View system information** and then click the **Computer Name** tab. Note the entry in the **Full computer name** field and enter it as the ZyAIR **System Name**.

3.3 Domain Name

The **Domain Name** entry is what is propagated to the DHCP clients on the LAN. If you leave this blank, the domain name obtained by a DHCP server is used. While you must enter the host name (System Name), the domain name can be assigned from the ZyAIR via DHCP.

3.4 iPnP

Traditionally, you must set the IP addresses and the subnet masks of a computer and the ZyAIR to be in the same subnet to allow the computer to access the Internet (through the ZyAIR). In cases where your computer is required to use a static IP address in another network, you may need to manually configure the network settings of the computer every time you want to access the Internet via the ZyAIR.

With the iPnP feature and NAT enabled, the ZyAIR allows a computer to access the Internet without changing the network settings (such as IP address and subnet mask) of the computer, when the IP addresses of the computer and the ZyAIR are not in the same subnet. Whether a computer is set to use a dynamic or static (fixed) IP address, you can simply connect the computer to the ZyAIR and access the Internet.

The following figure depicts a scenario where a computer is set to use a static private IP address in the corporate environment. In a residential house where a ZyAIR is installed, you can still use the computer to access the Internet without changing the network settings, even when the IP addresses of the computer and the ZyAIR are not in the same subnet.

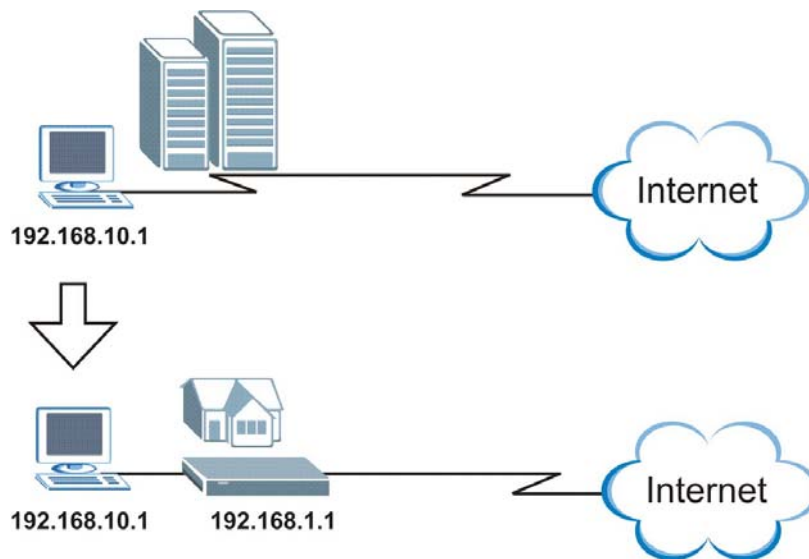

The iPnP feature does not apply to a computer using either a dynamic IP address or a static IP address that is in the same subnet as the ZyAIR's IP address.



You *must* enable NAT to use the iPnP feature.

3.4.1 How iPnP Works

Address Resolution Protocol (ARP) is a protocol for mapping an Internet Protocol address (IP address) to a physical machine address, also known as a Media Access Control or MAC address, on the local area network. IP routing table is defined on IP Ethernet devices (the ZyAIR) to decide which hop to use, to help forward data along to its specified destination.

The following lists out the steps taken, when a computer tries to access the Internet for the first time through the ZyAIR.

1. When a computer (which is in a different subnet) first attempts to access the Internet, it sends packets to its default gateway (which is not the ZyAIR) by looking at the MAC address in its ARP table.
2. When the computer cannot locate the default gateway, an ARP request is broadcast on the LAN.
3. The ZyAIR receives the ARP request and replies to the computer with its own MAC address.
4. The computer updates the MAC address for the default gateway to the ARP table. Once the ARP table is updated, the computer is able to access the Internet through the ZyAIR.
5. When the ZyAIR receives packets from the computer, it creates an entry in the IP routing table so it can properly forward packets intended for the computer.

After all the routing information is updated, the computer can access the ZyAIR and the Internet as if it is in the same subnet as the ZyAIR.

3.5 General System Settings

Click **ADVANCED** and then **SYSTEM** to open this screen.

SYSTEM

System/Host Name
 Domain Name

Location Information

Location Name: (Max =50)
 Address: (Max =200)
 City: (Max =50)
 State / Province: (Max =50)
 Zip / Postal Code: (Max =10)
 Country: (Max =50)
 Contact Name: (Max =50)
 Contact Telephone: (Max =50)
 Contact FAX: (Max =50)
 Contact Email: (Max =50)

Date/Time

Date: 2004 / 11 / 11 (Year/Month/Day)
 Time: 10 : 50 : 46 (Hour : Minute : Second)

Use NTP (Network Time Protocol) Time Server
 Server IP/Domain Name
 Time Zone GMT-12:00
 Update Time 0 hours
 Daylight Saving Time Start Date: 4 / 1 / Day
 End Date: 10 / 31 / Day

NAT (Network Address Translation)

Enable
 IP Plug and Play (IPnP Technology)
 DNS Fake IP Reply
 Disable

User Session Limited

Unlimited
 64 (1-1024)

Layer 2 Isolation Security

Enable Disable

Secure administrator IP addresses

Any
 Specify

<input type="text"/>	~	<input type="text"/>
<input type="text"/>	~	<input type="text"/>
<input type="text"/>	~	<input type="text"/>
<input type="text"/>	~	<input type="text"/>

Multicast Pass Through

Enable Disable

Allow remote user to ping the device

Enable Disable

SSL Certificate

Default Customer Certificate

Figure 3-1 SYSTEM

The following table describes the labels in this screen.

Table 3-1 SYSTEM

LABEL	DESCRIPTION
System/Host Name	Enter a descriptive name (up to 40 characters) for identification purposes.
Domain Name	Enter the domain name (if you know it) here. If you leave this field blank, the ZyAIR may obtain a domain name from a DHCP server. The domain name entered by you is given priority over the DHCP server assigned domain name.
Location Information	
Location Name	Enter the device's geographical location.
Address	Enter the street address of the device's location.
City	Enter the city of the device's location.
State/Province	Enter the state or province of the device's location.
ZIP/ Postal Code	Enter the zip code or postal code for the device's location.
Country	Enter the country of the device's location.
Contact Name	Enter the name of the person responsible for this device.
Contact Telephone	Enter the telephone number of the person responsible for this device.
Contact FAX	Enter the fax number of the person responsible for this device.
Contact Email	Enter the e-mail address of the person responsible for this device.
Date/Time	Set the system date and time by selecting the appropriate choices from the drop-down list boxes.
Get from my Computer	Click this button to set the time and date on the ZyAIR to be the same as the management computer.
Get from NTP server	Click this button to set the time and date on the ZyAIR to be the same as the management computer.
Use NTP (Network Time Protocol) Time Server	Select this check box to set the ZyAIR to get time and date information from an NTP (Network Time Protocol) time server.
Server IP/Domain Name	Enter the IP address or URL of your time server. Check with your ISP/network administrator if you are unsure of this information.
Time Zone	Choose the time zone of your location. This will set the time difference between your time zone and Greenwich Mean Time (GMT).
Update Time	Enter a number to determine how often the ZyAIR uses the NTP server to update the time and date.
Daylight Saving Time	Select this option if you use daylight savings time. Daylight saving is a period from late spring to early fall when many countries set their clocks ahead of normal local time by one hour to give more daytime light in the evening.
Start Date	Select the month and day that your daylight-savings time starts on if you selected Daylight Saving Time .
End Date	Select the month and day that your daylight-savings time ends on if you selected Daylight Saving Time .
NAT (Network Address Translation)	Enable NAT to have the ZyAIR translate Internet protocol addresses used within one network (for example a private IP address used in a local network) to a different IP address known within another network (for example a public IP address used on the Internet). See the <i>LAN Devices</i> chapter for more on NAT.

Table 3-1 SYSTEM

LABEL	DESCRIPTION
IP Plug and Play (iPnP Technology)	<p>Select this option to activate the iPnP feature. This allows a computer to access the Internet without changing the network settings (such as IP address and subnet mask) of the computer, even when the IP addresses of the computer and the ZyAIR are not in the same subnet.</p> <p>When you disable the iPnP feature, only computers with dynamic IP addresses or static IP addresses in the same subnet as the ZyAIR's LAN IP address can connect to the ZyAIR or access the Internet through the ZyAIR.</p>
DNS Fake IP Reply	<p>Some subscribers' Internet browsers may be set to use an HTTP proxy with a private domain. Select this option to have the ZyAIR send a default IP address (169.254.1.1) in response to DNS queries. This way the subscribers' computers can send HTTP requests that the ZyAIR can redirect so the subscribers can login.</p> <hr/> <p style="text-align: center;"> You <i>must</i> enable NAT to use this feature.</p>
User Session Limited	<p>Select Unlimited to not place any restriction on the number of sessions that each user connected to the ZyAIR can use.</p> <p>Select the other radio button and type a number (from 1 to 1024) if you want to specify how many sessions each user connected to the ZyAIR can use.</p>
Layer 2 Isolation Security	<p>If you activate NAT, select Enable in this field to prevent communication between subscribers. This is the default selection.</p> <p>Select Disable, to deactivate layer 2 security and allow communication between subscribers.</p>
Secure administrator IP addresses	<p>Select Any to use any computer to access the web configurator on the ZyAIR.</p> <p>Select Specify and then enter the IP address(es) or ranges of IP addresses of the computer(s) that are allowed to log in to configure the ZyAIR. The addresses can be on the LAN or the WAN.</p>
Multicast Pass Through	<p>Select Enable to allow multicast traffic to pass through the ZyAIR. This may affect your network performance.</p> <p>Select Disable to prevent any multicast traffic from passing through the ZyAIR. This is the default setting.</p>
Allow remote user to ping the device	<p>This feature affects the security of the ZyAIR's WAN port. Ping (Packet Internet Groper) is a protocol that sends out ICMP echo requests to test whether or not a remote host is reachable. Select Enable to have the ZyAIR respond to incoming Ping requests from the WAN. This is less secure since someone on the Internet can see that the ZyAIR is there by pinging it.</p> <p>Select Disable to have the ZyAIR not respond to incoming Ping requests from the WAN. This is more secure since someone on the Internet cannot see that the ZyAIR is there by pinging it.</p>
SSL Certificate	<p>Secure Socket Layer (SSL) security allows you to create secure connections between the ZyAIR and the management or subscriber computer(s).</p> <p>Select Default to use the default system-generated SSL certificate.</p> <p>Select Customer Certificate to use a certificate obtained from a certificate authority.</p> <p>Refer to the <i>SSL (Secure Socket Layer) Security</i> chapter for more information.</p>
Apply	Click Apply to save the changes.

Chapter 4

WAN, LAN and Server Setup

This chapter shows you how to configure LAN and WAN ports and server settings.

4.1 Factory Ethernet Defaults

The Ethernet parameters of the ZyAIR are preset to the following values:

- Dynamic WAN IP address.
- LAN IP address of 192.168.1.1 with subnet mask of 255.255.255.0
- DHCP server enabled on the LAN with a 253 client IP address pool starting from 192.168.1.2.

These parameters should work for the majority of installations. If you wish to change the factory defaults or to learn more about TCP/IP, please read on.

4.2 LANs and WANs

A LAN (Local Area Network) is a computer network limited to the immediate area, usually the same building or floor of a building. A WAN (Wide Area Network), on the other hand, is an outside connection to another network or the Internet.

4.3 IP Address Assignment

A static IP is a fixed IP that the ZyAIR obtains from a DHCP server on a network. A dynamic IP is not fixed; the DHCP server provides an IP address to the ZyAIR each time it connects to the network. When an Ethernet device is configured to obtain a dynamic IP address from a DHCP server, it is known as a DHCP client.

4.4 DHCP Configuration

DHCP (Dynamic Host Configuration Protocol) allows the individual clients (Ethernet device) to obtain the TCP/IP configuration at start-up from a centralized DHCP server. The ZyAIR has built-in DHCP server capability, which means it can assign IP addresses, an IP default gateway and DNS servers to computer systems that support the DHCP client when this feature is activated. The ZyAIR can also act as a surrogate DHCP server where it relays IP address assignment from the actual DHCP server to the clients.

4.4.1 IP Address and Subnet Mask

Like houses on a street that share a common street name, the computers on a LAN share one common network number.

Where you obtain your network number depends on your particular situation. If the ISP or your network administrator assigns you a block of registered IP addresses, follow their instructions in selecting the IP addresses and the subnet mask.

The Internet Assigned Number Authority (IANA) reserved a block of addresses specifically for private use (refer to *Section 4.4.2*); please do *not* use any other number unless you are told otherwise. Let's

say you select 192.168.1.0 as the network number; which covers 254 individual addresses, from 192.168.1.1 to 192.168.1.254 (zero and 255 are reserved). In other words, the first three numbers specify the network number while the last number identifies an individual computer on that network.

The subnet mask specifies the network number portion of an IP address.

4.4.2 Private IP Addresses

Every machine on the Internet must have a unique address. If your networks are isolated from the Internet, for example, only between your two branch offices, you can assign any IP addresses to the hosts without problems. However, the Internet Assigned Numbers Authority (IANA) has reserved the following three blocks of IP addresses specifically for private networks:

10.0.0.0 — 10.255.255.255
172.16.0.0 — 172.31.255.255
192.168.0.0 — 192.168.255.255

You can obtain your IP address from the IANA, from an ISP or it can be assigned from a private network. If you belong to a small organization and your Internet access is through an ISP, the ISP can provide you with the Internet addresses for your local networks. On the other hand, if you are part of a much larger organization, you should consult your network administrator for the appropriate IP addresses.

Regardless of your particular situation, do not create an arbitrary IP address; always follow the guidelines above. For more information on address assignment, please refer to RFC 1597, *Address Allocation for Private Internets* and RFC 1466, *Guidelines for Management of IP Address Space*.

4.5 DNS Server Address

DNS (Domain Name System) is for mapping a domain name to its corresponding IP address and vice versa. The DNS server is extremely important because without it, you must know the IP address of a machine before you can access it. The DNS server addresses that you enter in the DHCP setup are passed to the client machines along with the assigned IP address and subnet mask.

There are two ways that an ISP disseminates the DNS server addresses. The first is for an ISP to tell a customer the DNS server addresses, usually in the form of an information sheet, when s/he signs up. The second is to obtain the DNS server information automatically when a computer is set as a DHCP client.

4.6 PPPoE

Point-to-Point Protocol over Ethernet (PPPoE) functions as a dial-up connection. PPPoE is an IETF (Internet Engineering Task Force) standard specifying how a host personal computer interacts with a broadband modem (for example DSL, cable, wireless, etc.) to achieve access to high-speed data networks.

For the service provider, PPPoE offers an access and authentication method that works with existing access control systems (for instance, RADIUS).

One of the benefits of PPPoE is the ability to let end users access one of multiple network services, a function known as dynamic service selection. This enables the service provider to easily create and offer new IP services for specific users.

Operationally, PPPoE saves significant effort for both the subscriber and the ISP/carrier, as it requires no specific configuration of the broadband modem at the subscriber's site.

By implementing PPPoE directly on the ZyAIR (rather than individual computers), the computers on the LAN do not need PPPoE software installed, since the ZyAIR does that part of the task. Furthermore, with NAT, all of the LAN's computers will have Internet access.

4.6.1 PPP MTU

A maximum transmission unit (MTU) is the largest size packet or frame, specified in octets (eight-bit bytes) that can be sent in a packet- or frame-based network. The Transmission Control Protocol (TCP) uses the MTU to determine the maximum size of each packet in any transmission. Too large an MTU size may mean retransmissions if the packet encounters a router that can't handle that large a packet. Too small an MTU size means relatively more header overhead and more acknowledgements that have to be sent and handled.

4.6.2 TCP MSS

The maximum segment size (MSS) is the largest amount of data, specified in bytes, that a computer or communications device can handle in a single, unfragmented piece. For optimum communications, the number of bytes in the data segment and the header must add up to less than the number of bytes in the maximum transmission unit (MTU).

4.7 PPTP

Point-to-Point Tunneling Protocol (PPTP) is a network protocol that enables transfers of data from a remote client to a private server, creating a Virtual Private Network (VPN) using TCP/IP-based networks.

PPTP supports on-demand, multi-protocol, and virtual private networking over public networks, such as the Internet.

4.8 Configuring the WAN and LAN Settings

To configure the WAN and LAN settings on the ZyAIR, click **ADVANCED** and **LAN/WAN** to display the screen shown next.

Figure 4-1 WAN/LAN

The following table describes the labels in this screen.

Table 4-1 WAN/LAN

LABEL	DESCRIPTION
LAN	
IP Address	Enter the LAN IP address of the ZyAIR in dotted decimal notation. The default is 192.168.1.1 .
Subnet Mask	Enter the LAN subnet mask in dotted decimal notation. The default is 255.255.255.0 .

Table 4-1 WAN/LAN

LABEL	DESCRIPTION
WAN MAC Address	Select Default to use the factory assigned MAC address. If your ISP requires MAC address authentication, select Change to and enter the MAC address of a computer on the LAN in the fields provided.
WAN Port Mode	
DHCP Client	Select this option to set the ZyAIR to act as a DHCP client on the WAN. The ZyAIR obtains TCP/IP information (IP address, DNS server information, etc.) from a DHCP server. This is the default setting.
Static IP	Select this option to set the ZyAIR to use a static (or fixed) IP address.
IP Address	Enter the static IP address in dotted decimal notation.
Subnet Mask	Enter the subnet mask in dotted decimal notation.
Gateway IP address	Enter the IP address of the default gateway device. The gateway is a router or switch on the same network segment as the ZyAIR. The gateway helps forward packets to their destinations. Leave this field as 0.0.0.0 if you do not know it.
Primary/Secondary DNS Server	Enter the IP addresses of the primary and/or secondary DNS servers.
PPPoE	Select this option to activate PPPoE support. Refer to <i>Section 4.6</i> for more information.
Username	Enter the user name exactly as your ISP assigned. If assigned a name in the form user@domain where domain identifies a service name, then enter both components exactly as given.
Password	Enter the password associated with the user name above.
PPP MTU Setting	Enter the MTU (Maximum Transfer Unit) size.
TCP MSS Setting	Enter the MSS (Maximum Segment Size) size.
Service Name	Enter the name of your PPPoE service.
Connect on Demand	Select this option when you don't want the connection up all the time and specify an idle timeout in the Max Idle Time field. This is the default setting with an idle timeout of 10 minutes.
Keep Alive	Select this option when you want the Internet connection up all the time and specify a redial period in the Redial Period field. When disconnected, the ZyAIR will attempt to bring up the connection after the redial period.
PPTP	Select this option to activate PPTP support. Refer to <i>Section 4.7</i> for more information.
My IP Address	Enter the IP address assigned to you.
My Subnet Mask	Enter the subnet mask assigned to you.
Gateway IP address	Enter the IP address of the gateway device.
PPTP Server IP Address	Enter the IP address of your ISP's PPTP server.
Username	Enter the user name exactly as your ISP assigned. If assigned a name in the form user@domain where domain identifies a service name, then enter both components exactly as given.
Password	Enter the password associated with the user name above.
PPP MTU Setting	Enter the MTU (Maximum Transfer Unit) size.
TCP MSS Setting	Enter the MSS (Maximum Segment Size) size.

Table 4-1 WAN/LAN

LABEL	DESCRIPTION
Connection ID/Name	Enter your identification name of the PPTP server assigned to you by the ISP.
Connect on Demand	Select this option when you don't want the connection up all the time and specify an idle timeout in the Max Idle Time field. This is the default setting with an idle timeout of 10 minutes.
Keep Alive	Select this option when you want the Internet connection up all the time and specify a redial period in the Redial Period field. When disconnected, the ZyAIR will attempt to bring up the connection after the redial period.
Apply	Click Apply to save the changes.

4.9 Server Configuration

Use the **SERVER** screen to set the embedded web server, the LAN DHCP server and specify the e-mail server for e-mail redirection on the ZyAIR.

Click the **ADVANCED SETUP** and **SERVER** to display the screen as shown next.

The screenshot shows a configuration window with three sections:

- Web Server:**
 - HTTP Port: 80 (80, 8010 - 8060)
 - HTTPS Port: 443 (443, 4430 - 4440)
 - Administrator Idle-Timeout: 5 Min(s) (1 - 1440)
- DHCP Server:**
 - DHCP Disable
 - DHCP Relay
 - DHCP Server IP Address: []
 - DHCP Server (Default)
 - IP Pool Starting Address: 192.168.1.2
 - Pool Size: 253 (Max. = 253)
 - Lease Time: 300 (Minutes)
 - Primary DNS Server: 168.95.1.1
 - Secondary DNS Server: []
- Email Server Redirect:**
 - IP Address or Domain Name: []
 - SMTP Port: 25 (25, 2500 - 2599)

An "Apply" button is located at the bottom center of the window.

Figure 4-2 SERVER

The following table describes the fields in this screen.

Table 4-2 SERVER

LABEL	DESCRIPTION
Web Server	
HTTP Port	<p>Select this radio button if you want to access the ZyAIR using unsecured HTTP.</p> <p>Specify the port number of the embedded web server on the ZyAIR for accessing the web configurator. The default port number is 80. Changing the port number helps protect the ZyAIR's web configurator from hacker attacks.</p> <p>Enter a number between 8010 and 8060 to access the web configurator behind a NAT-enabled network.</p> <p>If you enter a number between 8010 and 8060, you need to append the port number to the WAN or LAN port IP address to access the web configurator. For example, if you enter "8010" as the web server port number, then you must enter "http://192.168.1.1:8010" where 192.168.1.1 is the WAN or LAN port IP address.</p>

Table 4-2 SERVER

LABEL	DESCRIPTION
HTTPS Port	<p>Select this radio button if you want to access the ZyAIR using secure HTTPS.</p> <p>Secure Socket Layer (SSL) security allows you to create secure connections between the ZyAIR and the management computer(s). Refer to the <i>SSL (Secure Socket Layer) Security</i> chapter for more information.</p> <p>Specify the port number of the embedded web server on the ZyAIR for accessing the web configurator. The default port number is 443. Changing the port number helps protect the ZyAIR's web configurator from hacker attacks.</p> <p>Enter a number between 4430 and 4440 to access the web configurator behind a NAT-enabled network.</p> <p>If you enter a number between 4430 and 4440, you need to append the port number to the WAN or LAN port IP address to access the web configurator. For example, if you enter "4430" as the web server port number, then you must enter "https://192.168.1.1:4430" where 192.168.1.1 is the WAN or LAN port IP address.</p>
Administrator Idle-Timeout	<p>Type how many minutes a management session can be left idle before the session times out. The default is 5 minutes. After it times out you have to log in with your password again. Very long idle timeouts may have security risks. A value of "0" means a management session never times out, no matter how long it has been left idle (not recommended).</p>
<p>DHCP Server</p> <p>Select the DHCP mode on the LAN.</p>	
DHCP Disable	<p>Select this option to disable DHCP server on the LAN.</p>
DHCP Relay	<p>Use this if you have a DHCP server (either a computer or another router) and you want that DHCP server to also assign network information (IP address, DNS information etc.) to the devices that connect to the ZyAIR. Select this option to set the ZyAIR to forward network configuration requests to a DHCP server.</p> <p>Then configure the DHCP Server IP Address field.</p>
DHCP Server IP Address	<p>If you select DHCP Relay, enter the IP address of a DHCP server (on the WAN).</p>
DHCP Server (Default)	<p>Select this option to set the ZyAIR to assign network information (IP address, DNS information etc.) to Ethernet device(s) connected to the LAN port(s). This is the default setting.</p>
IP Pool Starting Address	<p>Enter the first of the continuous addresses in the IP address pool.</p> <p>The default is 192.168.1.2.</p>
DHCP Pool Size	<p>This field specifies the size or count of the IP address pool. Enter a number not greater than 1024. The default is 253.</p>
Lease Time	<p>Specify the time (in minutes between 1 and 71582788) a DHCP client is allowed to use an assigned IP address. When the lease time expires, the DHCP client is given a new, unused IP address.</p>
Primary/Secondary DNS Server	<p>Enter the IP address of the DNS server(s) in the Primary DNS IP Address and/or Secondary DNS IP Address fields.</p> <hr/> <p> You must specify a DNS server.</p> <hr/>
E-mail Server Redirect	

Table 4-2 SERVER

LABEL	DESCRIPTION
IP Address or Domain Name	Specify the IP address or the domain name of the e-mail server to which the ZyAIR forwards e-mail.
SMTP Port	Enter the port number (25, or between 2500 and 2599) for the mail server. The default is 25 .
Apply	Click Apply to save the settings.

Part II:

Subscriber Account Management

This part covers the **ADVANCED AUTHENTICATION, RADIUS, BILLING, ACCOUNTING** and **CREDIT CARD** screens.

Chapter 5

Authentication

This chapter shows you how to set up subscriber authentication on the ZyAIR.

5.1 About the Built-in Authentication

You can use the built-in subscriber database to manage the subscribers. The ZyAIR also provides a built-in billing mechanism to set up accounting information without using accounting software or an accounting server (such as RADIUS).

5.2 Authentication Settings

Click **ADVANCED** and **AUTHENTICATION** to display the screen as shown next.

Figure 5-1 AUTHENTICATION

The following table describes the labels in this screen.

Table 5-1 AUTHENTICATION

LABEL	DESCRIPTION
No Authentication	Select this option to disable subscriber authentication. Subscribers can access the Internet without entering user names and passwords. This is the default setting.
Built-in Authentication	Select this option to authenticate the subscribers using the local subscriber database. <div style="text-align: center;">  <p>When you select this option, you <i>must</i> also configure the Accounting screen.</p> </div>

Table 5-1 AUTHENTICATION

LABEL	DESCRIPTION
Current User Information Backup	<p>The system provides automatic backup of account information and status. Use this field to set the number of minutes between backups. The default value is 1 minute. The valid range is 1 to 1440.</p> <p>If you create a subscriber account and the ZyAIR restarts before backing up the account information, the subscriber account will not be saved. You will need to create a new account for the subscriber.</p>
User Agreement	Select User Agreement to redirect a subscriber to an Internet service usage agreement page before accessing the Internet.
Redirect Login Page URL	Specify the URL of the user agreement page in the field provided. Click Code to display the HTML source code of a default sample page. The user agreement page must include the HTML source code in the default sample page in order for the user agreement page to send the subscribers' agreement or disagreement to the ZyAIR.
SSL Login Page Security	<p>Select Enable to activate SSL security upon accessing the subscriber login screen so that the subscribers' user names and passwords are encrypted before being transmitted to the ZyAIR. This applies when you select Built-in Authentication or User Agreement.</p> <p>Select Disable to de-activate SSL security for the subscriber login screen.</p> <p>Refer to the <i>SSL (Secure Socket Layer) Security</i> chapter for more information.</p>
Apply	Click Apply to save the changes.

Click **ADVANCED**, **AUTHENTICATION** and then **Code** to display the HTML source code of a default sample page (shown next). The user agreement page must include the HTML source code in the default sample page in order for the user agreement page to send the subscribers' agreement or disagreement to the ZyAIR.

```
Redirect Page Sample Code

<html>
<body>
<center>
<table width="100%" border="0">
<tr>
<td align="right" width="45%">
<form method="post" action="http://1.1.1.1/agree.cgi" name="agree">
<input type="submit" name="agree" value="Agree">
</form>
</td>
<td width="10%">&nbsp;</td>
<td width="45%">
<form method="post" action="http://1.1.1.1/disagree.cgi" name="disagree">
<input type="submit" name="disagree" value="Do not agree">
</form>
</td>
</tr>
</table>
</center>
</body>
</html>
```

Figure 5-2 Redirect Page Sample Code

Chapter 6

RADIUS

This chapter shows you how to configure the ZyAIR to use an external RADIUS server.

6.1 About RADIUS

You can use an external RADIUS (Remote Authentication Dial-In User Service) server to authenticate the subscriber connections and keep track of accounting information.

RADIUS is based on a client-server model that supports authentication, authorization and accounting. This system is the client and the server is the external RADIUS server.

RADIUS is a simple package exchange in which the ZyAIR acts as a message relay between the subscribers and the RADIUS server to establish a connection. When you enable RADIUS authentication, the ZyAIR uses RADIUS protocol (RFC 2865, 2866) to send subscriber authentication information to the external RADIUS server.

When you use an external RADIUS server for accounting, you can use either accumulation or time to finish accounting. See *Chapter 7* for information on accumulation and time to finish accounting.

6.2 RADIUS Settings

Click **ADVANCED** and then **RADIUS** to display the screen as shown next.

RADIUS

RADIUS Setup

Disable
 Enable

Accumulation --Idle Time Out **Min(s)**(1 - 1440)
 Time to Finish (Idle Time Out will be Disable)

Primary RADIUS Server:

Server IP address
 Authentication Port
 Accounting Port
 Shared Secret Key

Secondary RADIUS Server:

Server IP address
 Authentication Port
 Accounting Port
 Shared Secret Key

Retry times when Primary fail

Accounting Service:

Disable
 Enable

Interim Update Time: **Min(s)**

Authentication Method

Smart Client

IPASS GIS

Login Mode:

Directly Reply
 Proxy Reply with "Redirect Login Page" URL
 Proxy Reply with Specific URL

Figure 6-1 RADIUS

The following table describes the labels in this screen.

Table 6-1 RADIUS

LABEL	DESCRIPTION
RADIUS Setup	<p>Select Disable if you will not use an external RADIUS server to authenticate subscribers.</p> <p>Select Enable to use an external RADIUS server to authenticate subscribers. You may also use an external RADIUS server to perform accounting for the subscriber accounts.</p> <hr/> <p> Disabling authentication in the AUTHENTICATION screen also disables authentication via an external RADIUS server, regardless of what you set here.</p> <hr/>
Accumulation	<p>Select this option to allow each subscriber multiple re-login until the time allocated is used up.</p> <p>This applies to subscribers that are authenticated by the RADIUS server; the setting in the BILLING screen applies to subscribers that are authenticated by the local user database. You must also enable the accounting service below.</p>
Idle Time Out	<p>The ZyAIR automatically disconnects a computer from the network after a period of inactivity. The subscriber may need to enter the username and password again before access to the network is allowed.</p> <p>Specify the idle timeout between 1 and 1440 minutes. The default is 5 minutes.</p>
Time to Finish	<p>Select this option to allow each subscriber a one-time login. Once the subscriber logs in, the system starts counting down the pre-defined usage even if the subscriber stops the Internet access before the time period is finished.</p> <p>If a subscriber disconnects and reconnects before the allocated time expires, the subscriber does not have to enter the user name and password to access the Internet again.</p> <p>This applies to subscribers that are authenticated by the RADIUS server; the setting in the BILLING screen applies to subscribers that are authenticated by the local user database. You must also enable the accounting service below.</p>
Primary RADIUS Server	
Server IP address	Enter the IP address of the RADIUS server in dotted decimal notation.
Authentication Port	Enter the port number that the RADIUS server uses for authentication. You only need to change this value from the default if your network administrator gave you a specific port number to use. The allowed numbers are from 0 to 65535.
Accounting Port	Enter the port number that the RADIUS server uses for accounting. You only need to change this value from the default if your network administrator gave you a specific port number to use. The allowed numbers are from 0 to 65535.
Shared Secret Key	Enter a password (up to 64 characters) as the key to be shared between the RADIUS server and the ZyAIR. The key is not sent over the network. This key must be the same on the RADIUS server and the ZyAIR.
Secondary RADIUS Server	
Server IP address	Enter the IP address of the RADIUS server in dotted decimal notation.
Authentication Port	Enter the port number that the RADIUS server uses for authentication. You only need to change this value from the default if your network administrator gave you a specific port number to use. The allowed numbers are from 0 to 65535.

Table 6-1 RADIUS

LABEL	DESCRIPTION
Accounting Port	Enter the port number that the RADIUS server uses for accounting. You only need to change this value from the default if your network administrator gave you a specific port number to use. The allowed numbers are from 0 to 65535.
Shared Secret Key	Enter a password (up to 64 characters) as the key to be shared between the RADIUS server and the ZyAIR. The key is not sent over the network. This key must be the same on the RADIUS server and the ZyAIR.
Retry times when Primary fail	<p>At times the ZyAIR may not be able to use the primary RADIUS server. Select the number of times the ZyAIR should reattempt to use the primary RADIUS server before attempting to use the secondary RADIUS server. This also sets how many times the ZyAIR will attempt to use the secondary RADIUS server.</p> <p>For example, you set this field to 3. If the ZyAIR does not get a response from the primary RADIUS server, it tries again up to three times. If there is no response, the ZyAIR tries the secondary RADIUS server up to three times.</p> <p>If there is also no response from the secondary RADIUS server, the ZyAIR stops attempting to authenticate the subscriber. The subscriber will see a message that says the RADIUS server was not found.</p>
Accounting Service	<p>Select Disable if you will not use an external RADIUS server to perform accounting for the wireless client accounts.</p> <p>Select Enable to use an external RADIUS server to perform accounting for the wireless client accounts.</p>
Interim Update Time	Specify the time interval for how often the ZyAIR is to send a subscriber status update to the RADIUS server.
Authentication Method	<p>Enter the authentication protocol that the RADIUS server uses.</p> <p>PAP (Password Authentication Protocol) requires users to enter a password before accessing a secure system. The user's name and password are sent over the wire to a server where they are compared with a database of user account names and passwords.</p> <p>CHAP (Challenge Handshake Authentication Protocol) avoids sending passwords over the wire by using a challenge/response technique.</p>
IPASS GIS	The iPass company provides connectivity services for mobile Internet users. Select this check box to have the ZyAIR use the iPass Generic Interface Specification (GIS) method to authenticate iPass clients. Your external RADIUS servers must be Wi-Fi based Wireless Internet Service Provider roaming (WISPr) compliant in order to authenticate iPass clients.
Login Mode	<p>When using iPass GIS, your ISP will provide you with login mode information.</p> <p>Select Directly Reply, Proxy Reply with "Redirect Login Page" URL or Proxy Reply with Specific URL (and enter the URL in the field provided). The login mode information for the iPass GIS connection. (Provided by your ISP).</p>
Apply	Click Apply to save the changes.

Chapter 7

Billing

This chapter shows you how to set up subscriber billing on the ZyAIR.

7.1 About the Built-in Billing

You can use the built-in billing function to setup billing profiles. A billing profile describes how to charge subscribers.

7.1.1 Accumulation Accounting Method

The accumulation accounting method allows multiple re-logins until the allocated time period or until the subscriber account is expired. The ZyAIR accounts the time that the subscriber is logged in for Internet access.

7.1.2 Time-to-finish Accounting Method

The time-to-finish accounting method is good for one-time logins. Once a subscriber logs in, the ZyAIR stores the MAC address of the subscriber's computer for the duration of the time allocated. Thus the subscriber does not have to enter the user name and password again for re-login within the allocated time.

Once activated, the subscriber account is valid until the allocated time is reached even if the subscriber disconnects Internet access for a certain period within the allocated time. For example, Joe purchases a one-hour time-to-finish account. He starts using the Internet for the first 20 minutes and then disconnects his Internet access to go to a 20-minute meeting. After the meeting, he only has 20 minutes left on his account.

7.2 Billing Settings

Click **ADVANCED** and **BILLING** to display the screen as shown next.

BILLING

Pre-Paid
 Enable Credit Card Service
 Time to Finish
 Accumulation
 Idle Time Out Min(s) (1 - 1440)

Post-Paid
 Idle Time Out Min(s) (1 - 1440)

Billing Profile

Currency: \$ (Number of decimals places: (Dot))
 Tax Percentage: %

No	Active	Name (max. 12 characters)	Account Usage	Time	Charge
1	<input checked="" type="checkbox"/>	30 minutes	30	minutes	1.00
2	<input checked="" type="checkbox"/>	1 hour	1	hours	2.00
3	<input checked="" type="checkbox"/>	2 hours	2	hours	3.00
4	<input type="checkbox"/>	3 hours	3	hours	4.00
5	<input type="checkbox"/>	5 hours	5	hours	5.00
6	<input type="checkbox"/>	10 hours	10	hours	6.00
7	<input type="checkbox"/>	1 day	1	days	10.00
8	<input type="checkbox"/>	2 days	2	days	20.00
9	<input type="checkbox"/>	7 days	7	days	50.00
10	<input type="checkbox"/>	30 days	30	days	200.00

Figure 7-1 BILLING

The following table describes the labels in this screen.



If you change the billing mode, the system erases all accounts and disconnects all on-line subscribers.

Table 7-1 BILLING

LABEL	DESCRIPTION
Pre-Paid	Enable this option to allow the subscribers to access the Internet for a pre-defined time period.
Enable Credit Card Service	Enable the credit card service to authorize, process, and manage credit transactions directly through the Internet. Before you enable credit card service, make sure that your credit service is configured to work and the currency is American dollars. You must convert all prices on your billing page into American dollars (U.S. dollars). See the section on credit card for details.

Table 7-1 BILLING

LABEL	DESCRIPTION
Time to Finish	<p>Select this option to allow each subscriber a one-time login. Once the subscriber logs in, the system starts counting down the pre-defined usage even if the subscriber stops the Internet access before the time period is finished.</p> <p>If a subscriber disconnects and reconnects before the allocated time expires, the subscriber does not have to enter the user name and password to access the Internet again.</p>
Accumulation	<p>Select this option to allow each subscriber multiple re-login until the time allocated is used up.</p>
Idle Time Out	<p>The ZyAIR automatically disconnects a computer from the network after a period of inactivity. The subscriber may need to enter the username and password again before access to the network is allowed.</p> <p>Specify the idle timeout between 1 and 1440 minutes. The default is 5 minutes.</p>
Post-Paid	<p>A subscriber can access the Internet without a pre-defined usage time. The printout only shows the username and password. The hot spot operator can also use the optional keypad to terminate an account.</p> <hr/> <p style="text-align: center;"> You must use an optional keypad with the three-button printer in order to use the post-paid function.</p> <hr/>
Idle Time Out	<p>The ZyAIR automatically disconnects a computer from the network after a period of inactivity. The subscriber may need to enter the username and password again before access to the network is allowed.</p> <p>Specify the idle timeout between 1 and 1440 minutes. The default is 5 minutes.</p>
Currency	<p>Enter the appropriate currency unit or currency symbol.</p>
Number of decimals places	<p>Define the number of decimal places (up to 3) to be used for billing. You can also select whether you would like to use a period (.) or a comma (,) for the decimal point.</p>
Tax Percentage	<p>Select this check box to charge sales tax for the account. Enter the tax rate (a 5% sales tax is entered as 5).</p>
No.	<p>The index numbers of the billing profiles.</p>
Active	<p>Select the check box, to activate the billing profile or clear the check box to deactivate the billing profile.</p>
Name	<p>Enter a name (up to 12 characters) for the billing profile.</p>
Account Usage Time	<p>Use these fields to set the duration of the billing period. When this period expires, the subscriber's access will be stopped.</p> <p>Select a time period (minutes, hours, or days) and enter the time unit in the field provided to define each "profile's" maximum Internet access time.</p>
Charge	<p>Define each profile's price, up to 999999, per time unit (configured in the Account Usage Time field).</p>
Apply	<p>Click Apply to save the changes.</p>

Chapter 8

Accounting

This chapter shows you how to set up and manage subscriber accounts.

8.1 About Subscriber Accounts

Once the time allocated to a dynamic account is used up or a dynamic account remains un-used after the expiration time, the account is deleted from the account list. Accounts are automatically generated either by pressing a button on a connected exclusive printer or using the web configurator (the **Account Generator Panel** screen).

8.2 Discount Price Plan

You can configure a custom discount pricing plan. This is useful for providing reduced rates for purchases of longer periods of time. You can charge higher rates per unit at lower levels (fewer units purchased) and lower rates per unit at higher levels (more units purchased).

The discount price plan only works when the hot spot operator does the billing through a statement printer or the web-based account generator panel. The discount price plan does not apply to subscribers purchasing access time online with a credit card.

8.2.1 Charge by Levels

The discount price plan gives you the option to charge by levels. This allows you to charge the rate at each successive level from the first level (most expensive per unit) to the highest level (least expensive per unit) that the total purchase reaches.

Otherwise you can disable the charge by level function and charge all of the time units only at the highest (least expensive) level that the total purchase reaches.

See *section 8.3.1* for an example of the charge by levels accounting function.

8.3 Accounting Settings

Click **ADVANCED** and **ACCOUNTING** to display the screen as shown next.

ACCOUNTING

Expiration **Un-used account will be deleted after** **hours**
automatically.(1-60)
Accumulation account will be deleted after logged in

Printout **Number of copies to print :**
Replenish **Can be replenished by subscriber**

Web-based Account Generator Panel

Button A
Button B
Button C

Print to... **Account Generator Printer** **PC-Connected Printer**

Three-Buttons Printer

Button A same as Web-based Button A
Button B same as Web-based Button B
Button C same as Web-based Button C

Print to... **Account Generator Printer** **PC-Connected Printer**

Use **Discount Price Plan based on "Button Presses"**

Discount Price Plan based on "Button Presses" **Charge by levels**

Level	Conditions	Button Presses	Unit Price
1	when > =	1	same as base charge
2	when > =	<input type="text" value="0"/>	<input type="text" value=""/>
3	when > =	<input type="text" value="0"/>	<input type="text" value=""/>
4	when > =	<input type="text" value="0"/>	<input type="text" value=""/>
5	when > =	<input type="text" value="0"/>	<input type="text" value=""/>
6	when > =	<input type="text" value="0"/>	<input type="text" value=""/>
7	when > =	<input type="text" value="0"/>	<input type="text" value=""/>
8	when > =	<input type="text" value="0"/>	<input type="text" value=""/>
9	when > =	<input type="text" value="0"/>	<input type="text" value=""/>
10	when > =	<input type="text" value="0"/>	<input type="text" value=""/>

Figure 8-1 ACCOUNTING

The following table describes the labels in this screen.

Table 8-1 ACCOUNTING



LABEL	DESCRIPTION
Expiration	
Un-used account will be deleted after ~ automatically	Enter the number and select a time unit from the drop-down list box to specify how long to wait before the ZyAIR deletes an account that has not been used. This is for use with time to finish accounting.
Accumulation account will be deleted after logged in	Enter the number and select a time unit from the drop-down list box to specify how long to wait before the ZyAIR deletes an idle account. This is for use with accumulation accounting.
Printout	
Number of copies to print	Select how many copies of subscriber statements you want to print (1 is the default).
Replenish	
Can be replenished by subscriber	Select the check box to allow subscribers to purchase additional time units for their accounts before the accounts expire.
Web-based Account Generator Panel	
Preview/Operate	Click Preview/Operate to open the Account Generator Panel (see <i>Figure 8-3</i>).
Button A~C	Each button represents a billing profile that defines maximum Internet access time and charge per time unit. The buttons correspond to the buttons displayed in the Account Generator Panel . Select a billing profile from the list box for each button.
Print to...	<p>Select Account Generator Printer if you want to print the account information using a statement printer connected to the PRINTER port on the ZYAIR.</p> <p>Select PC-Connected Printer if you want to print the account information using a printer connected to a network computer.</p> <p>Click the  icon to display a print preview.</p>
Three-Buttons Printer	
Use this section with a three-button statement printer.	
Button A~C	These buttons correspond to the Web-based Account Generator Panel section's buttons A~C. Each button represents a billing profile that defines maximum Internet access time and charge per time unit.
Print to...	<p>Select Account Generator Printer if you want to print the account information using a statement printer connected to the PRINTER port on the ZYAIR.</p> <p>Select PC-Connected Printer if you want to print the account information using a printer connected to a network computer.</p> <p>Click the  icon to display a print preview.</p>

Table 8-1 ACCOUNTING

LABEL	DESCRIPTION
Use ~ Discount Price Plan based on "Button Presses"	Select a button from the drop-down list box to assign the base charge and select Enable to activate the discount price plan.
Discount Price Plan based on "Button Presses"	
Charge by levels	Disable the charge by level function to charge all of the subscriber's time units only at the highest level (least expensive) that their total number of button presses reaches. Enable the charge by levels function to charge the subscriber the rates at each successive level from the first level (least expensive) to the highest level (least expensive) that their total number of button presses reaches.
Level	These are the read-only level numbers of the discount charges.
Conditions	A discount level takes effect whenever the button selected in the Three button Printer Setting section is pressed more than or the same number of times as the number displayed in the Button Presses field.
Button Presses	Enter the number of times the button must be pressed to equal that discount level.
Unit Price	Enter each level's charge per time unit.
Apply	Click Apply to save your settings to the ZyAIR.

8.3.1 Charge By Levels Example

This is an example of how charge by levels accounting works. The discount price plan allows you to make the unit price lower as the subscriber purchases more (meaning a higher number of button pushes). The **Unit Price** for level 1 is always the same as the base charge (\$2.00 for this example). The following screen has discount price level 2 set to \$1.75 and level 3 set to \$1.50. Taxes are not included in this example.

Discount Price Plan based on "Button Presses" <input checked="" type="checkbox"/> Charge by levels			
Level	Conditions	Button Presses	Unit Price
1	when > =	1	same as base charge
2	when > =	5	1.75
3	when > =	10	1.50
4	when > =	0	

Figure 8-2 Charge By Levels Example

A subscriber purchases 11 units. Without charge by levels accounting, the total would be the number of button presses (11) multiplied by the unit price for the level that the number of button presses matches. In this case it would be 11x \$1.50 for a total of \$16.50 (excluding tax).

With charge by levels accounting, you charge the subscriber the rate at each successive level from the first level (most expensive per unit) to the highest level (least expensive per unit) that the purchase reaches. In this example, the ZyAIR would charge as follows:

Table 8-2 Charge By Levels Example

The base charge (\$2.00) per unit for button presses 1-4.	(\$2.00 x 4= \$8.00)
The level 2, unit price (\$1.75) per unit for button presses 5-9.	(\$1.75 x 5= \$8.75)
The level 3, unit price (\$1.50) per unit for button presses 10-11.	(\$1.50 x 2= \$3.00)
For a total of:	\$19.75 (excluding tax)

8.4 Creating Accounts

There are two ways to create subscriber accounts: using the **Account Generator Panel** screen in the web configurator or using an exclusive printer.

8.4.1 Creating Accounts in the Web Configurator

To create subscriber accounts, click **Preview/Operate** in the **ACCOUNTING** screen to display the **Account Generator Panel** screen shown next.

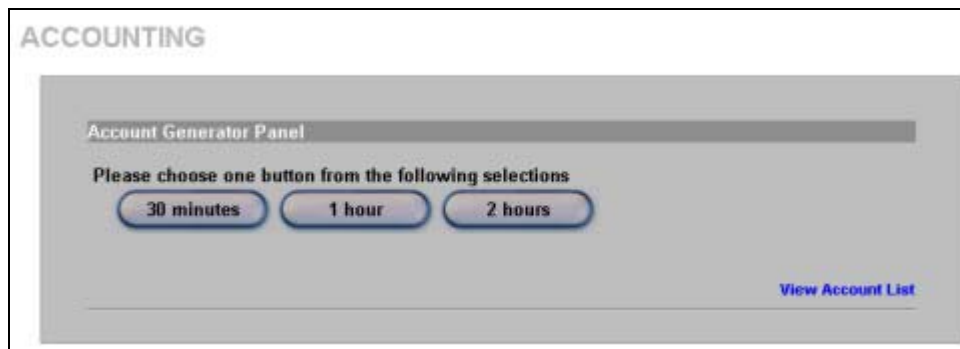

Figure 8-3 Account Generator Panel



These button settings also apply to the buttons on an exclusive printer.

Click a button to generate an account based on the settings you configure for the button in the **ACCOUNTING** screen. A window displays showing a printout preview of the account generated. The following figure shows an example. Close this window when you are finished viewing it.

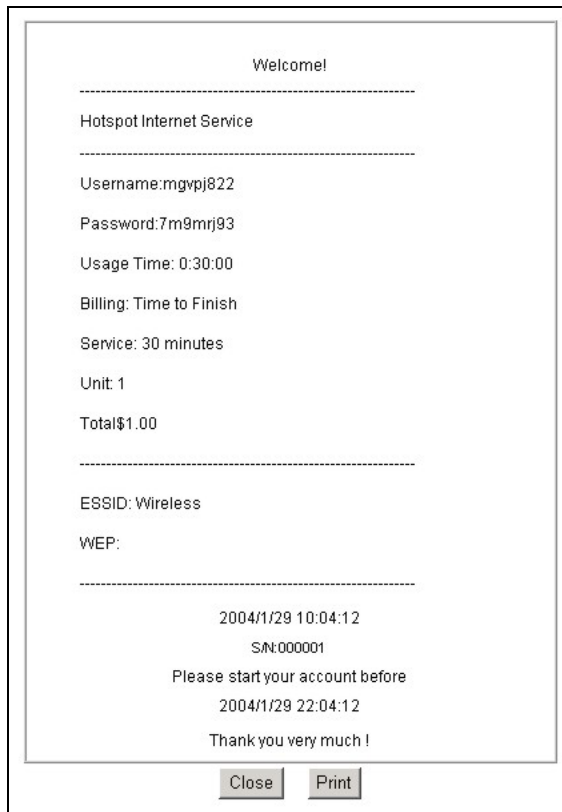

Figure 8-4 Web-based Account Generator Printout Preview Example



Figure 8-5 Web-based PC-connected Printout Preview Example

8.4.2 Using an Exclusive Printer to Create and Print Subscriber Statements

Follow the steps below to setup and create subscriber accounts and print subscriber statements using an external statement printer.

- Step 1.** Make sure that the printer is connected to the appropriate power and the ZyAIR, and that there is printing paper in the statement printer. Refer to the printer's *User's Guide* for details.
- Step 2.** Press the button on the statement printer. The ZyAIR generates a dynamic account and the printer prints the subscriber's statement. Refer to *Figure 8-4* for a printout example.

Refer to section 8.3 to configure the printout page.

8.5 Viewing the Account List

Do one of the following to view the account list.

- From the **Account Generator Panel** screen (refer to *Figure 8-3*) and click **View Account List**.
- From the **SYSTEM STATUS** sub-menus, click **ACCOUNT LIST**.

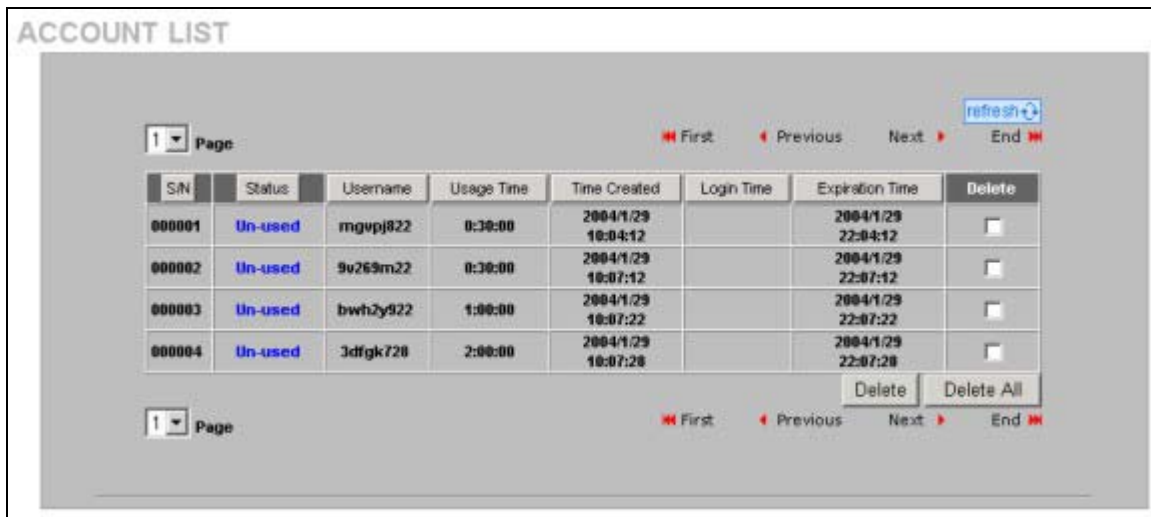

Figure 8-6 Account List

The following table describes the labels in this screen.

Table 8-3 Account List

LABEL	DESCRIPTION
Refresh	Click Refresh to update this screen.
S/N	This field displays the index number of an entry. The maximum number of subscriber account entries is 512.
Status	This field displays IN-Used when the account is currently in use. Otherwise it displays UN-Used .
Username	This field displays the account user name. Click the heading to sort the entries in ascending or descending order based on this column.
Usage Time	This field displays the amount of time the subscriber has purchased. Click the heading to sort the entries in ascending or descending order based on this column.
Time Created	This field displays when the account was created (in yyyy/mm/dd hh/mm/ss format). Click the heading to sort the entries in ascending or descending order based on this column.

Table 8-3 Account List

LABEL	DESCRIPTION
Login Time	This field displays when the subscriber logged in to use the account (in yyyy/mm/dd hh/mm/ss format). Click the heading to sort the entries in ascending or descending order based on this column.
Expiration Time	This field displays when the subscriber's account becomes invalid (in yyyy/mm/dd hh/mm/ss format). When the subscriber has already logged into the account, this field displays the time until which the subscriber can continue to use the account to access the Internet. When the subscriber has not yet logged into the account, this field displays the time that the account expires if the subscriber does not log into it. Click the heading to sort the entries in ascending or descending order based on this column.
Delete All	Click Delete All to remove all accounts.
Delete	Select the Delete checkbox(es) next to individual accounts and click Delete to remove the selected accounts.
Page	Select a page number from the drop-down list box to display the selected page.
First	Click First to go to the first page.
Previous	Click Previous to return to the previous page.
Next	Click Next to go to the next page.
End	Click End to go to the last page.

Refer to the appendices for more information on logging in as a subscriber.

Chapter 9

Credit Card

This chapter shows you how to set the ZyAIR to handle credit card transactions.

9.1 About the Credit Card Screen

The ZyAIR allows you to use a credit card service to authorize, process, and manage credit transactions directly through the Internet. You must register with the Authorize.Net credit card service (www.authorizenet.com) or WorldPay before you can configure the ZyAIR to handle credit card transactions. Call 1-866-437-0476 for an Authorize.Net account.

9.2 Credit Card Settings

Click **ADVANCED** and **CREDIT CARD** to display the screen as shown next.

CREDIT CARD

Authorize.net

Version: 3.1

Merchant ID:

Merchant Password: Need Password:

Merchant Transaction Key:

Payment Gateway:

Email Additional Information

Merchant Name: (max. 40 characters)

Username and Password

Usage Time

WorldPay

Payment Gateway: (max. 200 characters)

Installation ID: (max. 20 characters)

Currency Code: (max. 3 characters)

Description: (max. 100 characters)

Test Mode:

Credit Card icons to be displayed on the login page





   

Figure 9-1 CREDIT CARD

The following table describes the labels in this screen.

Table 9-1 CREDIT CARD

LABEL	DESCRIPTION
Authorize.net	Select this radio button if you use Authorize.net to authorize credit card payments.
Version	This is the (read-only) software version of the Authorize.net payment Gateway.
Merchant ID	Enter the IDentification number that you received from Authorize.net.
Merchant Password Need	Check this box if you have to provide a password to Authorize.net.
Merchant Password	Enter the password you have to provide to Authorize.net.
Merchant Transaction Key	Enter the transaction key exactly as you received it from Authorize.net. The transaction key is similar to a password. The Authorize.net gateway uses the transaction key to authenticate transactions.
Payment Gateway	Enter the address of the Authorize.net gateway. The default value is "https://cardpresent.authorize.net/gateway/transact.dll".
Email Additional Information	Select this check box to have the ZyAIR e-mail the subscriber the information that you specify in the following fields.
Merchant Name	Select this check box to have the ZyAIR include the company name in the e-mail that it sends to the subscriber. Enter the company name (up to 40 characters) in the field provided.
Username and Password	Select this check box to have the ZyAIR e-mail the subscriber the subscriber user name and password.
Usage Time	Select this check box to have the ZyAIR e-mail the subscriber the amount of usage time purchased.
WorldPay	Select this radio button if you use WorldPay to authorize credit card payments.
Payment Gateway	Enter the address of the WorldPay gateway provided to you by WorldPay after applying for your WorldPay account. The default value is "https://select.worldpay.com/wcc/purchase".
Installation ID	Enter the installation ID provided to you by WorldPay after successfully applying for your WorldPay account.
Currency Code	Enter the currency in which payments are made. The available currencies depend on your agreement with WorldPay.
Description	Enter the description of each purchase. This description appears on the customer's receipt.
Test Mode	Check this box if you want to evaluate the way WorldPay is used without actually transferring funds. There are two test modes, Success and Fail . In Success test mode, transactions are submitted as if the bank authorized the transaction. In Fail test mode, transactions are submitted as if the bank declined authorization.
Credit Card icons to be displayed on the login page	Select the checkbox(es) of the credit card icon(s) that you want the ZyAIR to display on the subscriber login page.
Apply	Click Apply to save your settings to the ZyAIR.

Part III:

Advanced Subscriber Account Management

This part covers the **ADVANCED KEYPAD, CUSTOMIZATION, PASS THROUGH, FILTERING** and **SHARE** screens.

Chapter 10 Keypad

This chapter shows you how to set up the optional keypad for an exclusive printer.

10.1 About the Keypad

You can use an optional PS/2 numeric keypad with an exclusive printer. Use this screen to define functions for the keys.

10.2 Keypad Settings

Click **ADVANCED** and **KEYPAD** to display the screen as shown next.

KEYPAD

Use for Pre-Paid Billing

Keypad Hot Key	Billing Profile
+1	(01) 30 minutes, 30 minute(s), \$1.00 ▾
+2	(01) 30 minutes, 30 minute(s), \$1.00 ▾
+3	(01) 30 minutes, 30 minute(s), \$1.00 ▾
+4	(01) 30 minutes, 30 minute(s), \$1.00 ▾
+5	(01) 30 minutes, 30 minute(s), \$1.00 ▾
+6	(01) 30 minutes, 30 minute(s), \$1.00 ▾
+7	(01) 30 minutes, 30 minute(s), \$1.00 ▾
+8	(01) 30 minutes, 30 minute(s), \$1.00 ▾
+9	(01) 30 minutes, 30 minute(s), \$1.00 ▾
+0	(01) 30 minutes, 30 minute(s), \$1.00 ▾

Use for Post-Paid Billing

Based on minutes ▾ **Charge by levels**

Level	Conditions	Time Range	Unit Price
1	when > =	1	1.00
2	when > =	0 <input style="width: 40px;" type="text"/>	<input style="width: 40px;" type="text"/>
3	when > =	0 <input style="width: 40px;" type="text"/>	<input style="width: 40px;" type="text"/>
4	when > =	0 <input style="width: 40px;" type="text"/>	<input style="width: 40px;" type="text"/>
5	when > =	0 <input style="width: 40px;" type="text"/>	<input style="width: 40px;" type="text"/>
6	when > =	0 <input style="width: 40px;" type="text"/>	<input style="width: 40px;" type="text"/>
7	when > =	0 <input style="width: 40px;" type="text"/>	<input style="width: 40px;" type="text"/>
8	when > =	0 <input style="width: 40px;" type="text"/>	<input style="width: 40px;" type="text"/>
9	when > =	0 <input style="width: 40px;" type="text"/>	<input style="width: 40px;" type="text"/>
10	when > =	0 <input style="width: 40px;" type="text"/>	<input style="width: 40px;" type="text"/>

Figure 10-1 KEYPAD

The following table describes the labels in this screen.

Table 10-1 KEYPAD

LABEL	DESCRIPTION
Use for Pre-Paid Billing	The system provides ten user definable hot keys through the use of the + Key plus the 1 through 0 keys across the top of the keypad.
Keypad Hot Key	+1~+0 This is the combination hot key for a keypad application.
Billing Profile	Select the billing profile that you want to assign to the combination hot key. Use the Billing screen to configure and activate billing profiles. Only active billing profiles display here for you to choose from.
Use for Post-Paid Billing	Use the following fields to define the basic charge levels and rates for accounts.
Base on	Select the billing time unit from the drop-down list box.
Charge by levels	Use this field to enable or disable the charge by levels function. See the <i>Accounting</i> chapter for details on the charge by levels function.
Level	These are the read-only level numbers of the charges.
Time Range	Enter the number of time units (defined in the Base on field) for this charge level.
Unit Price	Enter each level's charge per time unit.
Apply	Click Apply to save the changes.

10.3 Keypad Configuration Examples

These sections explain how to configure the ZyAIR for use with a PS/2 keypad.

10.3.1 Keypad with Pre-Paid Billing Example

The following is an example of how to configure the ZyAIR to use a PS/2 keypad for pre-paid billing.

Step 1. Click **ADVANCED, BILLING**.

Step 2. Select **Pre-Paid** and click **Apply**.

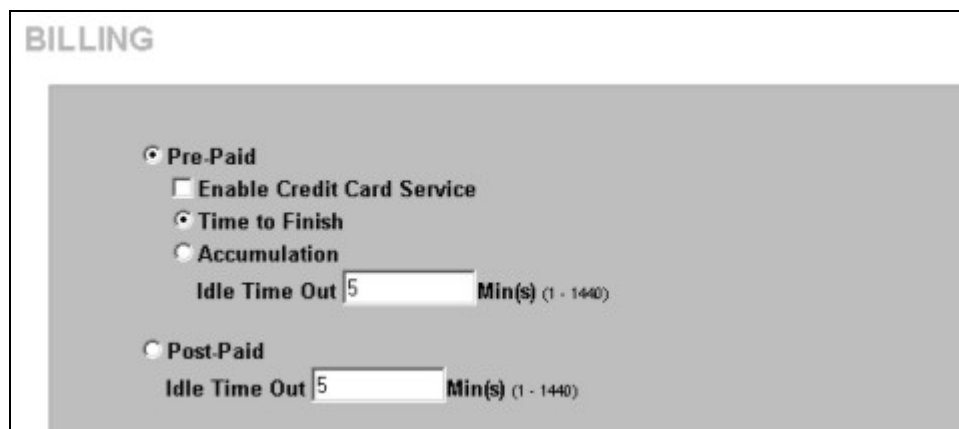

Figure 10-2 Select Pre-Paid Billing

Step 3. Click **ADVANCED, KEYPAD**.

Step 4. Define your pre-paid billing profiles and click **Apply**.

KEYPAD

Use for Pre-Paid Billing

Keypad Hot Key	Billing Profile
+1	(01) 30 minutes, 30 minute(s), \$1.00
+2	(02) 1 hour, 1 hour(s), \$2.00
+3	(03) 2 hours, 2 hour(s), \$3.00
+4	(01) 30 minutes, 30 minute(s), \$1.00
+5	(01) 30 minutes, 30 minute(s), \$1.00
+6	(01) 30 minutes, 30 minute(s), \$1.00
+7	(01) 30 minutes, 30 minute(s), \$1.00
+8	(01) 30 minutes, 30 minute(s), \$1.00
+9	(01) 30 minutes, 30 minute(s), \$1.00
+0	(01) 30 minutes, 30 minute(s), \$1.00

Figure 10-3 Define Pre-Paid Billing Profiles

Step 5. Use the keypad to create subscriber accounts. Press the keypad hot key and then [ENTER] to generate a new subscriber account and print the account information.

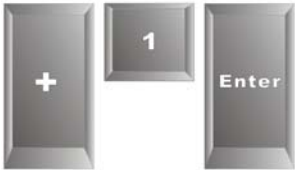

→ **The first Billing Profile**
(01) 30 minutes, 30 minute(s), \$1.00

Welcome!

Hotspot Internet Service

Username: b4e55f35
 Password: xz6g6n82
 Billing: Time to Finish
 Service: 30 minutes
 Unit: 1
 Usage Time: 00:30:00
 Total: \$ 1.00
 Tax: \$0.00
 Grand Total: \$ 1.00

ESSID: Wireless
 WEP:
 2003/11/06 11:19:05
 S/N: 000001
 Please activate your
 account before
 2003/11/06 23:19:05

Thank you very much!



→ **The second Billing Profile**
(02) 1 hour, 1 hour(s), \$2.00

Welcome!

Hotspot Internet Service

Username: 7spt858
 Password: jic7rp55
 Billing: Time to Finish
 Service: 1 hour
 Unit: 1
 Usage Time: 01:00:00
 Total: \$ 2.00
 Tax: \$0.00
 Grand Total: \$ 2.00

ESSID: Wireless
 WEP:
 2003/11/06 11:24:58
 S/N: 000002
 Please activate your
 account before
 2003/11/06 23:24:58

Thank you very much!

Figure 10-4 Billing Profiles 1 and 2 Examples

10.3.2 Keypad with Post-Paid Billing Example

The following is an example of how to configure the ZyAIR to use a PS/2 keypad for post-paid billing.

Step 1. Click **ADVANCED, BILLING**.

Step 2. Select **Post-Paid** and click **Apply**.

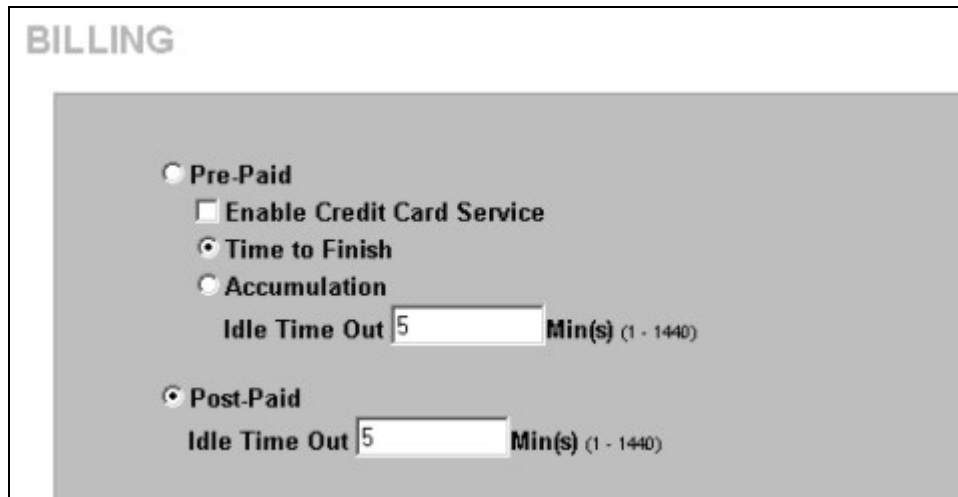

Figure 10-5 Select Post-Paid Billing

Step 3. Click **ADVANCED, KEYPAD**.

Step 4. Define your post-paid billing plan and click **Apply**.



Figure 10-6 Define Post-Paid Billing Plan

Step 5. Use the keypad to create subscriber accounts. Press [ENTER] to generate a new subscriber account and print the account's information. The account information includes a serial number, password and the time the account was created.

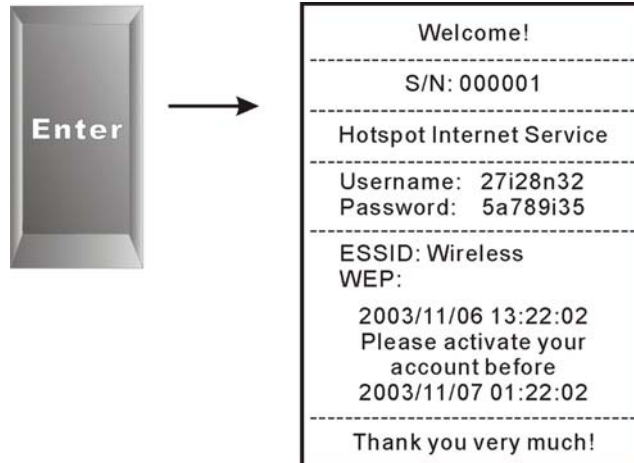

Figure 10-7 Post-Paid Account Printout Example

Step 6. When a subscriber is done using the Internet service, press the following to print a bill.

- a. *
- b. Serial number
- c. [ENTER]

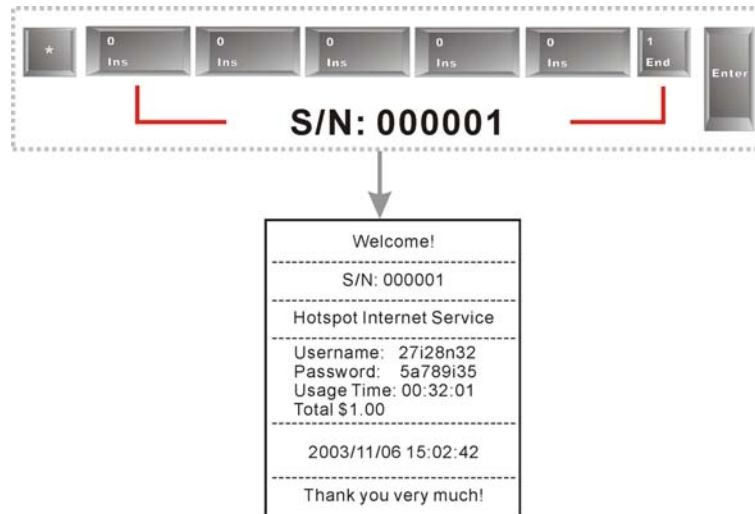

Figure 10-8 Post-Paid Account Bill Printout Example

Chapter 11

Customization

This chapter shows you how to customize the subscriber interface.

11.1 About the Customization Screens

Use these screens to tailor what displays on the subscriber interface. You can configure the subscriber login screen, which logo displays; an information window, the account printouts and the credit card billing interface.

11.2 About the Login Page Screen

When subscriber authentication is activated in the **Authentication** screen, the subscriber login screen is the first screen that all subscribers see when trying to access the Internet. You can configure walled garden web addresses for web sites that all subscribers are allowed to access without logging in (refer to the chapter on advertisement links and walled garden).

The ZyAIR provides different formats in which you can customize the login screen: **Standard**, **Redirect**, **Advanced** and **Frame**.

11.3 Customizing the Subscriber Login Screen

To customize the subscriber login screen, click **ADVANCED**, **CUSTOMIZATION** and **Login Page** to display the screen as shown next.

CUSTOMIZATION

Login Page	Logo	Information Windows	Account Printout	Credit Card
<p><input checked="" type="radio"/> Standard</p> <p>Please enter the customizable message on the standard login page</p> <p><input type="checkbox"/> Logo</p> <p>Title <input type="text" value="Welcome"/> (Max. 80 characters)</p> <p>Subtitle <input type="text" value="Hot Spot Internet Service"/> (Max. 80 characters)</p> <p>Username <input type="text" value="Username"/> (Max. 20 characters)</p> <p>Password <input type="text" value="Password"/> (Max. 20 characters)</p> <p>Enter Button <input type="text" value="Enter"/> (Max. 20 characters)</p> <p>Cancel Button <input type="text" value="Cancel"/> (Max. 20 characters)</p> <p><input type="checkbox"/> Footnote <input type="text" value="Please contact us if you have any ques"/> (Max. 240 characters)</p> <p><input checked="" type="checkbox"/> Copyright <input type="text" value="Copyright (c) 2002-2004 All Rights Res"/> (Max. 80 characters)</p> <p>Background Color <input type="text" value="FFFFFF"/> View Color Grid</p> <p align="right"> Standard Login Page Preview</p>				
<p><input type="radio"/> Redirect</p> <p>Redirect Login Page URL: <input type="text"/> Code</p>				
<p><input type="radio"/> Advanced</p> <p>Welcome Slogan <input type="text"/></p> <p>Page Background <input checked="" type="radio"/> None <input type="radio"/> Background Color <input type="text" value="FFFFFF"/> View Color Grid</p> <p>Article <input type="text"/></p> <p>Article Text Color <input type="text" value="000000"/> View Color Grid</p> <p>Article Background Color <input checked="" type="radio"/> None <input type="radio"/> <input type="text" value="FFFFFF"/> View Color Grid</p> <p>Information <input type="text"/></p> <p>Comments <input type="text"/></p>				
<p><input type="radio"/> Frame</p> <p>Top Frame: URL <input type="text"/></p> <p>Down Frame: This frame will show the standard login page</p>				
<p><input type="button" value="Apply"/></p>				

Figure 11-1 Customization

11.3.1 Standard Subscriber Login Screen

The standard subscriber login screen is the ZyAIR’s pre-configured, default simple login screen. In **Login Page**, select **Standard**.

Standard

Please enter the customizable message on the standard login page

Logo

Title (Max. 80 characters)

Subtitle (Max. 80 characters)

Username (Max. 20 characters)

Password (Max. 20 characters)

Enter Button (Max. 20 characters)

Cancel Button (Max. 20 characters)

Footnote (Max. 240 characters)

Copyright (Max. 80 characters)

Background Color [View Color Grid](#)

 [Standard Login Page Preview](#)

Figure 11-2 Login Page: Standard

Table 11-1 Login Page: Standard

LABEL	DESCRIPTION
Logo	Select this check box to display your logo on the subscriber login screen. See section 11.4 for how to upload a logo file.
Title	Enter the title name (up to 80 characters) on the subscriber login page.
Subtitle	Enter the subtitle name (up to 80 characters) on the subscriber login screen.
Username	Enter the name of the Username field on the subscriber login screen.
Password	Enter the name of the Password field on the subscriber login screen.
Enter Button	Enter the name for the Enter button on the subscriber login screen.
Cancel Button	Enter the name for the Cancel button on the subscriber login screen.
Footnote	Select the check box to add a footnote to the subscriber login page. Enter the footnote (up to 240 characters) in the field provided.
Copyright	Select the check box to add copyright information to the bottom of the subscriber login page. Enter the copyright information (up to 80characters) in the field provided.
Background Color	Enter a hexadecimal number to set the color of the login screen background to the color specified, for example, enter '000000' for black. Click View Color Grid to display a list of web-friendly colors and corresponding hexadecimal values.
Standard Login Page Preview	Click this link to preview the standard login screen in a new browser window.

The following figure shows an example of what a subscriber sees when logging in.

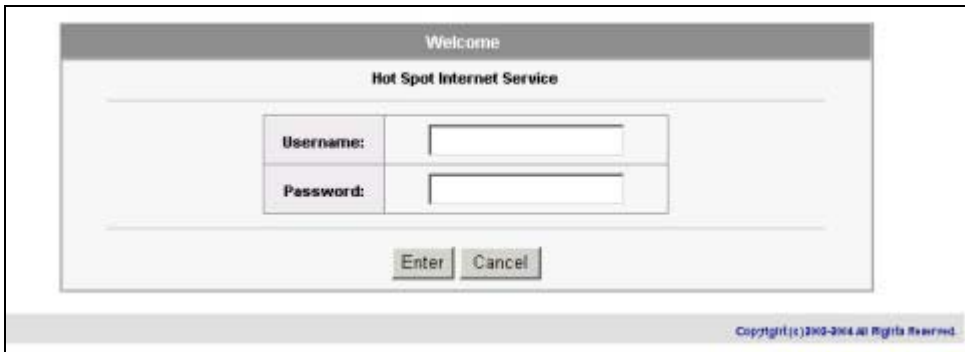

Figure 11-3 Login Page Example: Standard

11.3.2 Redirect Subscriber Login Screen

You can set the ZyAIR to redirect the subscribers to another login screen. This allows you to use your own customized login screen that you have created with a website-design tool. This gives you the ability to use a company login page and/or add multimedia features such as flash.

In the **Login Page** screen, select **Redirect**.



Figure 11-4 Login Page: Redirect

The following table describes the related labels.

Table 11-2 Login Page: Redirect

LABEL	DESCRIPTION
Redirect	Select this option to direct the subscriber to another login screen.
Redirect Login Page URL	Specify the web site address to which the ZyAIR directs the subscribers for logins. The web site must be on the WAN.
Code	Click Code to display the source code of the web page you specify above (see <i>Figure 11-5</i>). The redirect subscriber login screen must include the HTML source code in the default sample page in order for the subscriber login screen to send the subscribers' usernames and passwords to the ZyAIR.

```

Redirect Login Page Code
<html>
<body style="font-family: Arial" bgcolor="#FFFFFF">
<form method="post" action="http://1.1.1.1/login.cgi" name="apply">
<div align="center">
<table cellSpacing="0" cellPadding="0" width="50%" borderColorLight="#8e8e8e"
border="1">
<tr>
<td align="center" width="100%" bgColor="#8e8e8e" height="24">
<font face="Arial, Helvetica, sans-serif" size="2" color="#FFFFFF"><b>Welcome</b></font>
</td>
</tr>
<tr>
<td align="center"> <table cellSpacing="0" cellPadding="4" width="100%"
bgColor="#FFFFFF" border="0"> <tr>
<td align="right" width="35%" style="font-family: Arial, Helvetica, sans-serif; font-size: 12pt">
<font color="#000000" size="2"><b>Username:</b></font>
</td>
<td width="65%">
<input type="text" name="username" size="25">
</td>
</tr>
<tr>
<td align="right" width="35%" style="font-family: Arial, Helvetica, sans-serif; font-size: 12pt">
<font color="#000000" size="2"><b>Password:</b></font>
</td>
<td width="65%">
<input type="password" name="password" size="25">
</td>
</tr>
<tr>
<td align="center" width="100%" style="font-family: Arial; font-size: 12pt" bgcolor="#F7F7F7"
colspan="2">
<input type="submit" name="apply" value="Enter" style="font-family: Arial">
<input type="reset" name="clear" value="Clear" style="font-family: Arial">
</td>
</tr>
</table>
</td>
</tr>
</table>
</div>
</form>
</body>
</html>

```

Figure 11-5 Login Page: Redirect Code

11.3.3 Advanced Subscriber Login Screen

Use the **Advanced** login screen option to customize a login screen where you can create a welcome slogan and add advertising information.

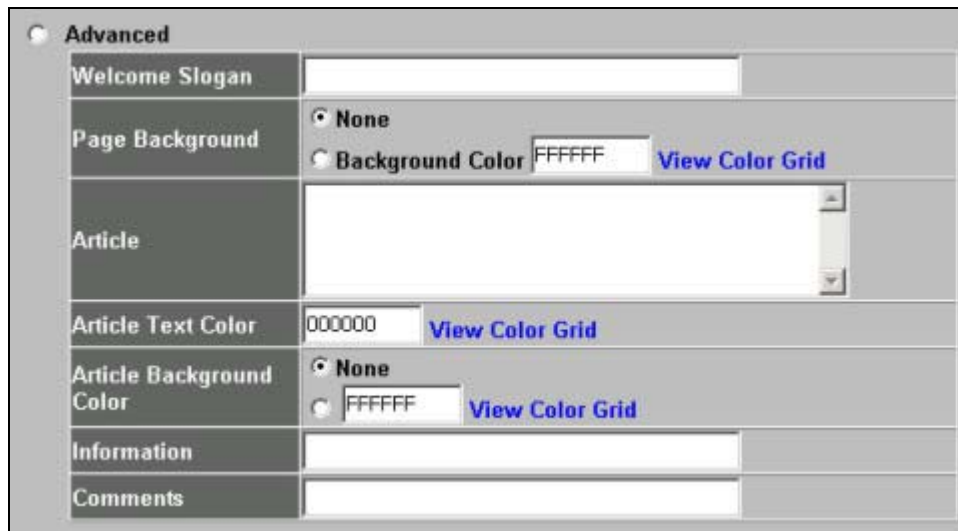

Figure 11-6 Login Page: Advanced

The following table describes the related labels.

Table 11-3 Login Page: Advanced

LABEL	DESCRIPTION
Advanced	Select this option to set the ZyAIR to display the advanced subscriber login screen.
Welcome Slogan	Enter a welcome message (up to 80 characters long) in the text box provided.
Page Background	Select None to set the background color of the login screen to white (the default). Select Background Color to set the color of the login screen background to the color specified, for example, enter '000000' for black. Click View Color Grid to display a list of web-friendly colors and corresponding hexadecimal values.
Article	Enter a block of text (up to 1024 characters long) in the text box. This is useful for advertisements or announcements.
Article Text Color	Select None to set the article text color of the login screen to white (the default). Select and set the color of the article text block background to the color specified, for example, enter '000000' for black. Click View Color Grid to display a list of web-friendly colors and corresponding hexadecimal values.
Article Background Color	Select None to set the article background color of the login screen to white (the default). Select the other radio button to set the color of the login screen's article background to the color specified, for example, enter '000000' for black. Click View Color Grid to display a list of web-friendly colors and corresponding hexadecimal values.
Information	Enter information such address and telephone or fax numbers in the text box provided. Up to 80 characters allowed.
Comments	Enter any comments (up to 80 characters long) in the text box provided.

The web-friendly color sets are displayed in the figure shown.

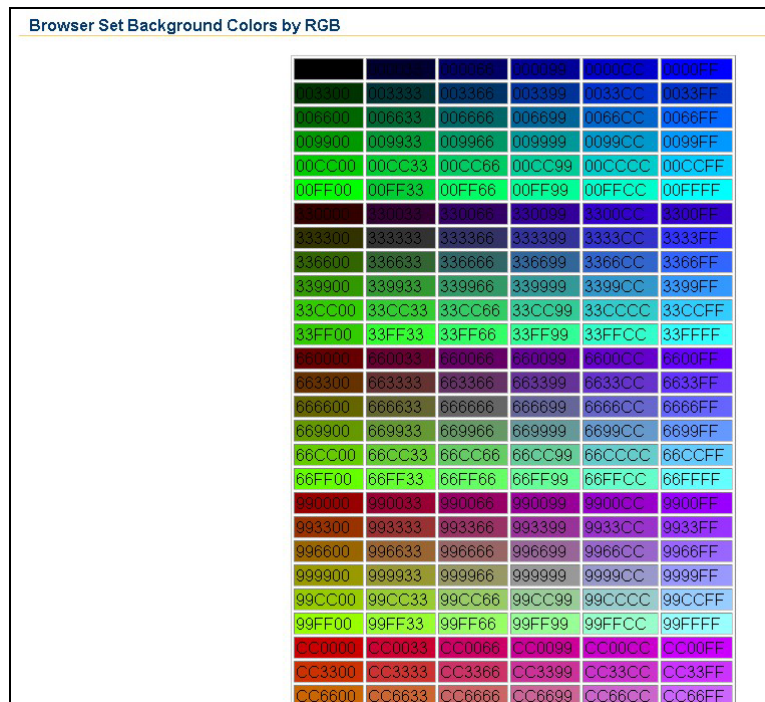

Figure 11-7 Login Page: Color Grid

The following figure shows an advanced subscriber login screen example.

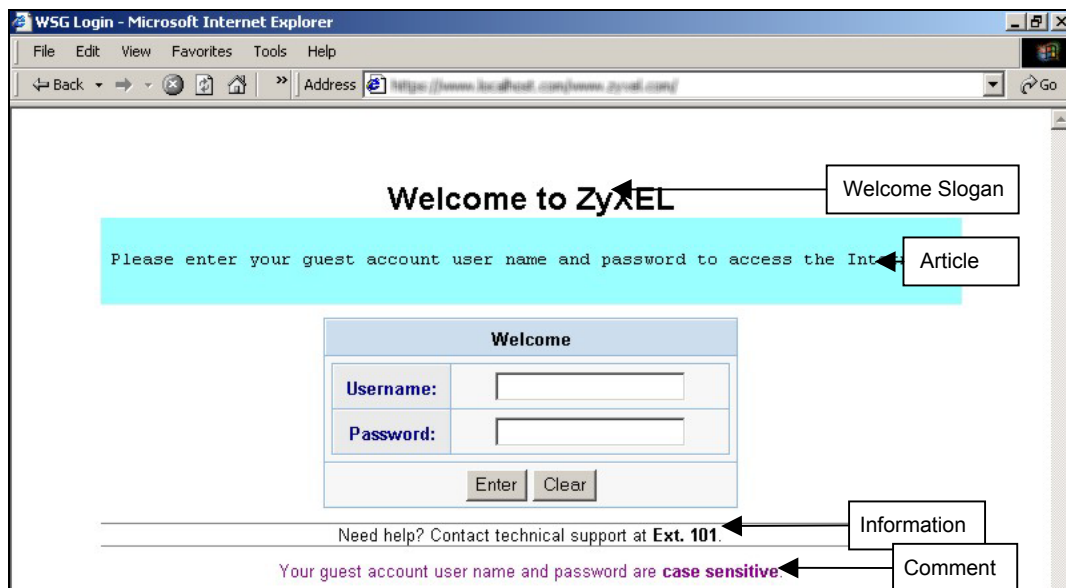

Figure 11-8 Subscriber Login Screen Example: Advanced

11.3.4 Framed Subscriber Login Screen

The **Frame** login screen splits the login screen into two frames: top and bottom. You can specify a web site to be displayed in the top frame with the user name and password prompt displayed in the bottom frame. The frame login screen is useful for you to link to a web site (such as the company web

site) as your welcome screen. In addition, you can externally design a web page with images and/or advanced multimedia features.

Frame
Top Frame: URL
Down Frame: This frame will show the standard login page

Figure 11-9 Subscriber Login Screen: Frame

The following table describes the related labels.

Table 11-4 Subscriber Login Screen: Frame

LABEL	DESCRIPTION
Frame	Select this option to configure and set the ZyAIR to display the subscriber login screen in two frames.
Top Frame	Enter a web site address in the URL Link field, for example, http://www.zyxel.com.
Down Frame	The bottom frame displays the standard subscriber login page.

The following figure shows a framed subscriber login screen example.

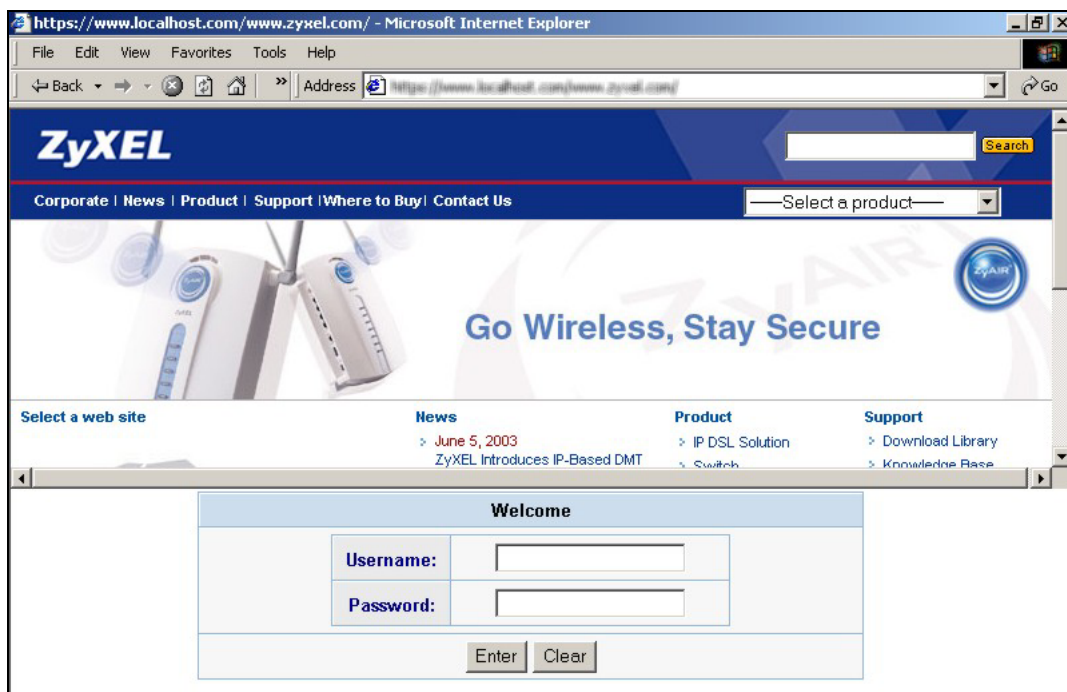

Figure 11-10 Subscriber Login Screen Example: Frame

11.4 Adding a Logo

This function allows you to upload a file containing your logo. The logo can be shown on the standard login page and the account printout when printing with a network-connected printer.

To upload your logo file, click **ADVANCED**, **CUSTOMIZATION** and **Logo** to display the screen as shown next.

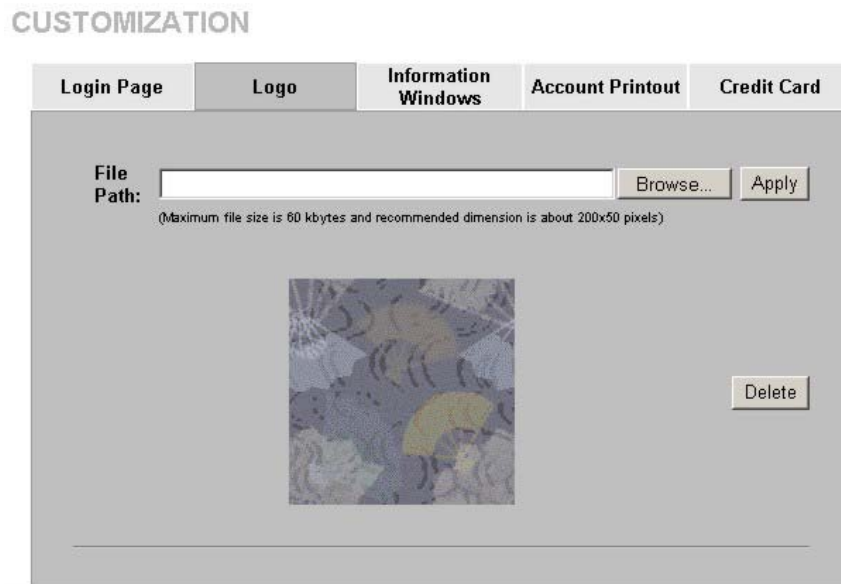

Figure 11-11 Logo

The following table describes the labels in this screen.

Table 11-5 Logo

LABEL	DESCRIPTION
File Path	Enter the file pathname of the logo file or click Browse to search for it.
Apply	Click Apply to upload your logo file to the ZyAIR.
Delete	Click Delete to remove the logo you uploaded.

11.5 About the Information Windows

You can set the ZyAIR to display an information window after a subscriber has successfully logged in. This information window shows the amount of time a subscriber has used or the time the subscriber still has to access the Internet.

The subscriber information window varies depending on the account type and billing configuration you set on the ZyAIR.

The information window displays the amount of time used for Internet access on a super subscriber account. With other types of account, the information window displays the amount of time a subscriber still has to use for Internet access.

When you set the system to allow accounts to be replenished, the information window displays a **Replenish** button.

When you set the billing type to accumulation, the information window displays a **Logout** button.

11.5.1 Customizing the Information Windows

Click **ADVANCED**, **CUSTOMIZATION** and **Information Windows** to display the screen as shown next.

To display the information window on the subscriber's computer after a successful login, select the **Display Information Window once after a subscriber logs in successfully** check box.

Figure 11-12 Customization: Information Windows

The following table describes the labels in this screen.

Table 11-6 Customization: Information Windows

LABEL	DESCRIPTION
Window name	Enter a descriptive name (up to 30 characters) as the title of the window.
Main message	Enter a short message (up to 30 characters).
Message Description	Enter a short description about the information window.
Time count label	Standard for pre-defined usage time -Enter the label for the field displaying the remaining time. This field displays when the ZyAIR is set to use pre-paid billing. Post-Paid Billing -Enter the label for the field displaying the amount of time used. This field displays when the ZyAIR is set to use post-paid billing.
Warning/Alarm Message	Select this check box to display the warning message that you enter in the text box provided.
Notice Message	Select this check box to display any additional message(s) that you enter in the text box(es) provided. You can specify up to three additional messages (such as discount information) in the information window.

Table 11-6 Customization: Information Windows

LABEL	DESCRIPTION
Preview	Click Preview to display a preview of the information window.
Apply	Click Apply to save the changes.

11.6 About the Account Printout

After you have created the subscriber accounts, you can print out the account information.

11.6.1 Customizing the Account Printout

To customize the account printout, click **ADVANCED**, **CUSTOMIZATION** and **Account Printout** to display the screen as shown.

CUSTOMIZATION

Login Page
Logo
Information Windows
Account Printout
Credit Card

Customize Printout Label Setting

Logo * Only for PC-connected printer

Title

Subtitle

Username

Password

Billing Method

Billing Profile

Purchase Unit

Usage Time

Price

TAX

ESSID

WPA Encryption

WEP Encryption

Additional Label 1

Additional Label 2

Print out Time

Expiration Time

Ending

(Max.=96)

(Max.=96)

(Max.=24)

(Max.=24)

(Max.=24)

(Max.=24)

(Max.=24)

(Max.=24)

(Max.=24)

(Max.=24) **TOTAL:** (Max.=24)

(Max.=24)

(Max.=24)

(Max.=24)

(Max.=24) **Value:** (Max.=24)

(Max.=24) **Value:** (Max.=24)

Format: (HH:24h hh:12h tt:AM/PM)

Description: (Max.=72)

Format: (HH:24h hh:12h tt:AM/PM)

Accumulation: (Max.=96)

(Max.=240)

[Preview of PC-connected printer](#)

[Preview of account generator printer](#)

[Preview of Post-Paid Printout](#)

Figure 11-13 Account Printout

The following table describes the labels in this screen.

Table 11-7 Account Printout

LABEL	DESCRIPTION
Logo	Select this check box to print your logo on the account statement when you use a network-connected printer. See section 11.4 for how to upload a logo file.
Title	Enter a title for the printout.
Subtitle	Enter a subtitle for the printout.
Username	Enter the label name for the field displaying the account username.
Password	Enter the label name for the field displaying the account password.
Billing Method	Enter the label name for the field displaying the method for billing.
Billing Profile	Enter the label name for the field displaying the name for the billing profile used.
Purchase Unit	Enter the label name for the field displaying the number of time units purchased.
Usage Time	Enter the label name for the field displaying the amount of time an account is allowed for Internet access.
Price	Select this check box to display the specified label name for the field displaying the price.
TAX	Enter a label name for the field displaying the tax.
TOTAL	Enter a label name for the field displaying the sum of the price and the tax.
ESSID	Type a label name for the field displaying the wireless LAN's Extended Service Set Identifier (ESSID).
WPA Encryption	Type a label name for the field displaying the Wi-Fi Protected Access (WPA Encryption) key. This field displays on the account statement when the ZyAIR is using WPA data encryption with a pre-shared key.
WEP Encryption	Type a label name for the field displaying the Wired Equivalent Privacy (WEP Encryption) key. This field displays on the account statement when the ZyAIR is using WEP data encryption.
Additional Label 1 and 2	Select this check box to display the specified label name(s) for the field(s) displaying any additional information.
Print out Time	Select this check box to display the time an account is printed out. Select date and time formats from the drop-down list boxes.
Expiration Time	Select this check box to display the time an account expires. Enter an explanation for the subscriber about the account's expiration. Select date and time formats from the drop-down list boxes.
Accumulation	This message displays in the account printout when you set the ZyAIR to use accumulation billing. Enter an explanation for the subscriber about the deadline for using the purchased time.
Ending	Select this check box to display a message at the end of the printout. Enter the message in the text box provided.
Preview of PC-connected printer	Click Apply to save your changes and then click this link to display a preview of an account printout, as it would print on a printer connected to a network computer.
Preview of account generator printer	Click this link to display a preview of an account printout, as it would print on an external account generator printer (or the statement printer).

Table 11-7 Account Printout

LABEL	DESCRIPTION
Preview of Post-Paid Printout	Click this link to display a preview of a post-paid account printout.
Apply	Click Apply to save the changes.

The following figures show account printout examples.

Welcome!	
Hotspot Internet Service	
Username:	XXXXXXXX
Password:	XXXXXXXX
Billing:	Time to Finish
Service:	1 day \$35.00
Unit:	1
Usage Time:	
Total	\$100.00
ESSID:	Wireless
WEP:	
S/N:000001	2004/2/5 08:39:43
Please activate your account before 2004/2/5 20:39:43	
Thank you very much !	
Close	Print

Figure 11-14 Preview of PC-connected Printer Example



Figure 11-15 Preview of Account Generator Printer Example

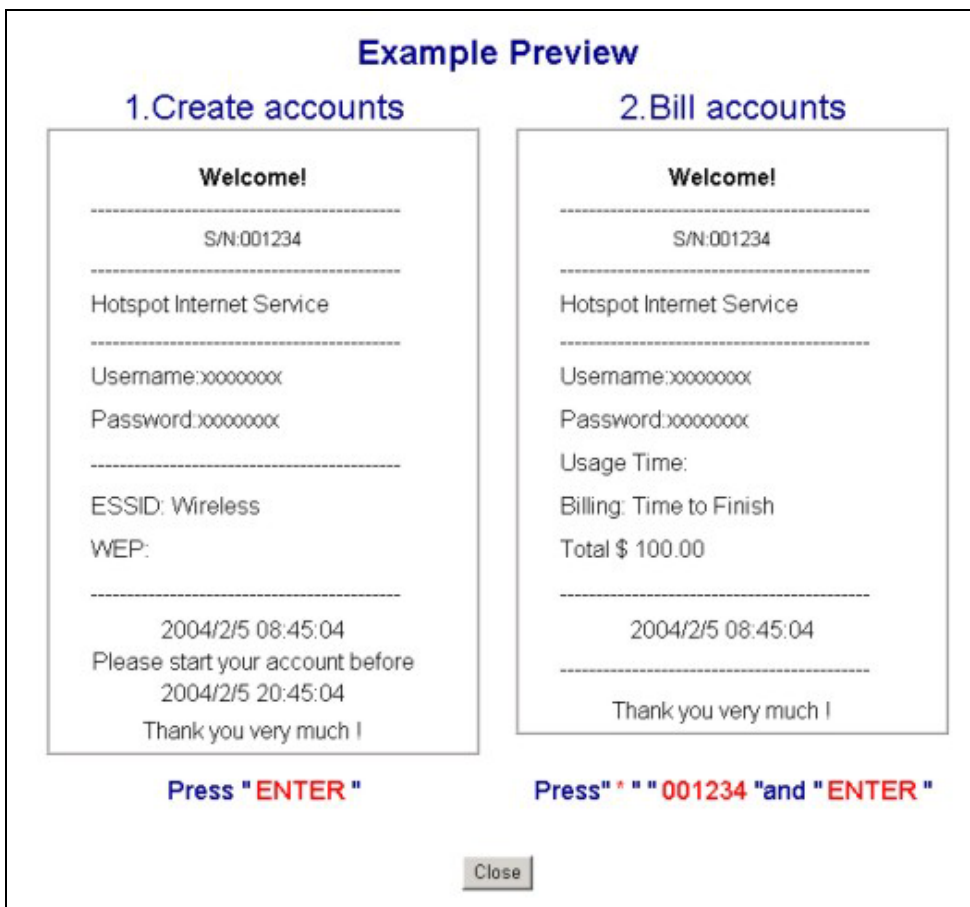

Figure 11-16 Preview of Post-Paid Printout Example

11.7 Customizing the Credit Card

When you configure the ZyAIR to use credit card billing, you can use this page to customize the subscriber billing interface. Click **ADVANCED**, **CUSTOMIZATION** and **Credit Card** to display the screen as shown.

11.7.1 Credit Card Standard Login Page

Use this section to customize the credit card message that displays on the standard login page.

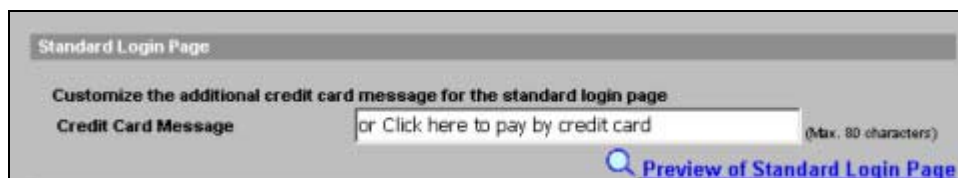

Figure 11-17 Credit Card: Standard Login Page

The following table describes the labels in this section.

Table 11-8 Credit Card: Standard Login Page

LABEL	DESCRIPTION
Standard Login Page	Enter the credit card message that you want to display on the standard login page. The message you configure here only displays on the standard login page when you configure and enable credit card service.
Preview of Standard Login Page	Click this link to display a preview of the standard login page.

The following figure shows an example of the standard login page with the credit card option.

**Figure 11-18 Credit Card Standard Login Page Example**

11.7.2 Credit Card Service Selection Page

Use this section to customize the credit card billing interface that displays on the subscriber's screen.

Service Selection Page

Customize the message for the service selection page

Service Selection Message
(Max. 80 characters)

Purchase Unit Message
(Max. 80 characters)

Notification Message 1
(Max. 160 characters)

Notification Message 2
(Max. 160 characters)

Notification Message 3
(Max. 160 characters)

Enter Payment Information
(Max. 160 characters)

Enter Credit Card Number
(Max. 80 characters)

Enter Credit Card expiration date
(Max. 80 characters)

Enter Email Address
(Max. 80 characters)

Submit Button
(Max. 40 characters)

Merchants may provide additional customer information with a transaction, based on their respective requirements.

Credit Card Code
(Max. 40 characters)

Customer ID
(Max. 40 characters)

First/Last Name
(Max. 20 characters) (Max. 20 characters)

Company
(Max. 40 characters)

Address
(Max. 40 characters)

City
(Max. 40 characters)

State/Province
(Max. 40 characters)

ZIP/Postal Code
(Max. 40 characters)

Country
(Max. 40 characters)

Phone
(Max. 40 characters)

Fax
(Max. 40 characters)

 [Preview of Service Selection Page](#)

Figure 11-19 Credit Card Service Selection Page

The following table describes the labels in this section.

Table 11-9 Credit Card Service Selection Page

LABEL	DESCRIPTION
Service Selection Message	Enter a message to instruct the subscribers to select a billing profile. Use the Billing screen to configure and activate billing profiles. Only active billing profiles display on the subscriber's screen.
Purchase Unit Message	Enter a message to instruct the subscribers to select the number of time units to purchase.
Notification Message (1-3)	Enter an additional message(s) regarding the purchase of Internet access. For example, you may enter a refund policy.
Enter Payment Information	Enter a message to instruct the subscribers to provide the required payment information.
Enter Credit Card Number	Enter a label name for the field where the subscriber enters the credit card number.
Enter Credit Card expiration date	Enter a label name for the field where the subscriber enters the credit card's expiration date.
Enter Email Address	Enter a label name for the field where the subscriber enters an e-mail address.
Submit Button	Enter a label name for the button the subscriber clicks to submit the transaction information.
Optional Information	You may select check boxes to display additional fields on the credit card billing interface that displays on the subscriber's screen.
Credit Card Code	Credit cards have an authorization code on the back. Select this check box if you want the screen to display a credit card authorization code field. Enter the label name for the field that requests the subscriber's credit card authorization code.
Customer ID	Select this check box if you want the screen to display a customer ID field. A customer with an Authorize.net-issued ID can enter it in the field. Enter the label name for the field that requests the subscriber's ID.
First/Last Name	Select this check box if you want the screen to display the first and last name fields. Enter the label names for the fields that request the subscriber's first and last name.
Company	Select this check box if you want the screen to display a company field. Enter the label name for the field that requests the name of the subscriber's company.
Address	Select this check box if you want the screen to display an address field. Enter the label name for the field that requests the subscriber's address.
City	Select this check box if you want the screen to display a city field. Enter the label name for the field that requests the name of the city where the subscriber lives.
State/Province	Select this check box if you want the screen to display a state or province field. Enter the label name for the field that requests the subscriber's state or province.
ZIP/ Postal Code	Select this check box if you want the screen to display a zip or postal code field. Enter the label name for the field that requests the subscriber's zip or postal code.
Country	Select this check box if you want the screen to display a country field. Enter the label name for the field that requests the subscriber's country.
Phone	Select this check box if you want the screen to display a phone number field. Enter the label name for the field that requests the subscriber's phone number.
Fax	Select this check box if you want the screen to display a fax number field. Enter the label name for the field that requests the subscriber's fax number.

Table 11-9 Credit Card Service Selection Page

LABEL	DESCRIPTION
Preview of Service Selection Page	Click this link to display a preview of the credit card service selection page that will display on the subscriber's screen.

The following figure shows an example preview of the credit card service selection page.

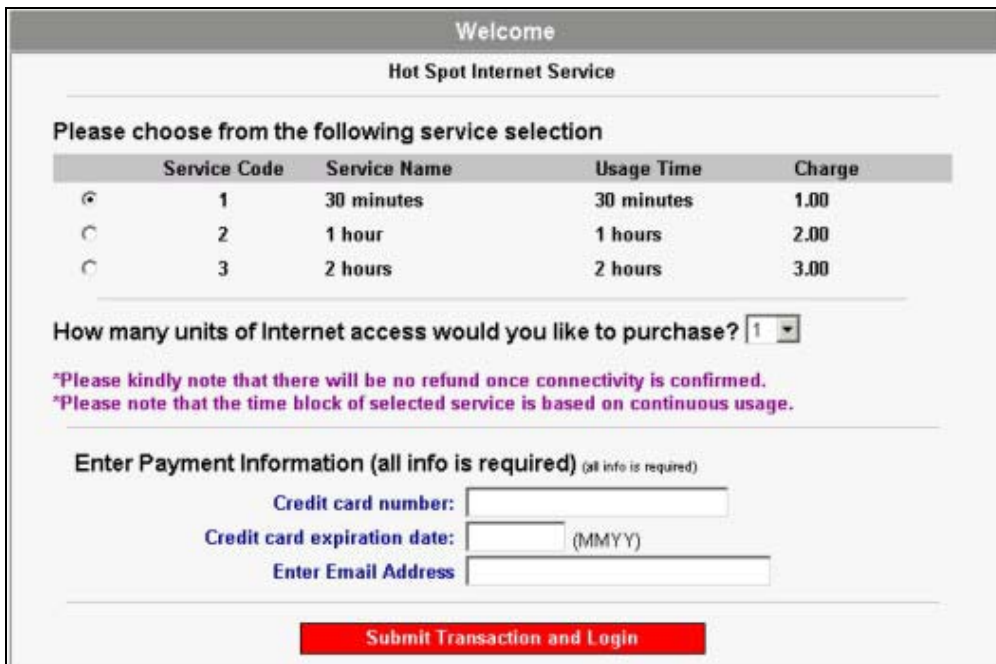

Figure 11-20 Credit Card Service Selection Page Preview

11.7.3 Credit Card Successful Page

Use this section to customize the page that displays on the subscriber's screen if an attempt to use a credit card is successful.

Successful Page

Customize the message for the successful page

Successful Message
(Max. 80 characters)

Notification Message 1
(Max. 160 characters)

Notification Message 2
(Max. 160 characters)

Account Information
(Max. 160 characters)

Username
(Max. 80 characters)

Password
(Max. 80 characters)

Usage Time
(Max. 80 characters)

Expiration Time
(Max. 80 characters)
Format:
(HH:24h hh:12h tt:AM/PM)

Email Button
(Max. 40 characters)

Submit Button
(Max. 40 characters)

[Preview of Successful Page](#)

Figure 11-21 Credit Card Successful Page

The following table describes the labels in this section.

Table 11-10 Credit Card Successful Page

LABEL	DESCRIPTION
Successful Message	Enter a message to tell the subscriber that the online credit card transaction was successful.
Notification Message (1-2)	Enter an additional message(s) regarding the subscriber's use of the purchased Internet access.
Account Information	Enter a message to tell the subscriber about the account information in the following fields.
Username	Enter a label name for the field that displays the subscriber's user name.
Password	Enter a label name for the field that displays the subscriber's password.
Usage Time	Enter a label name for the field that displays the subscriber's purchased period of Internet access.
Expiration Time	Enter the label name for the field displaying when the account expires. Select date and time formats from the drop-down list boxes.
Email Button	Enter a label name for the button the subscriber can click to send a copy of the account information to the subscriber's e-mail account.
Submit Button	Enter a label name for the button the subscriber clicks to log into the account.
Preview of Successful Page	Click this link to display a preview of the credit card transaction successful page that will display on the subscriber's screen.

The following figure shows an example preview of the credit card transaction successful page.



Figure 11-22 Credit Card Successful Page Preview

11.7.4 Credit Card Fail Page

Use this section to customize the page that displays on the subscriber's screen if an attempt to use a credit card fails.

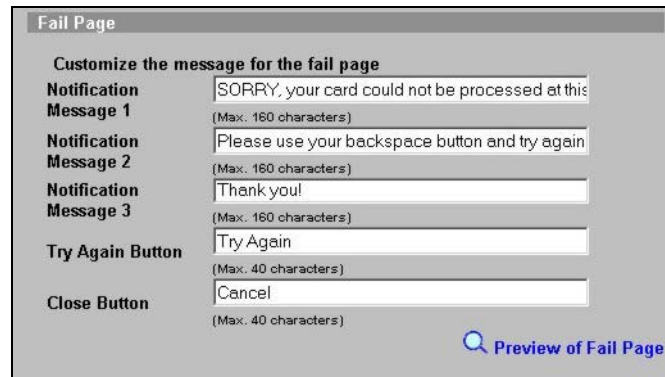

Figure 11-23 Credit Card Service Fail Page

The following table describes the labels in this section.

Table 11-11 Credit Card Service Fail Page

LABEL	DESCRIPTION
Notification Message (1-3)	Enter a message(s) to tell the subscriber that the online credit card transaction failed and how to try again.
Try Again Button	Enter a label name for the button that takes the subscriber back to the credit card service selection page.
Close Button	Enter a label name for the button that the subscriber can use to stop attempting to make a credit card transaction and close the credit card interface.
Preview of Fail Page	Click this link to display a preview of the credit card transaction failed page that will display on the subscriber's screen.

The following figure shows an example preview of the credit card transaction failed page.

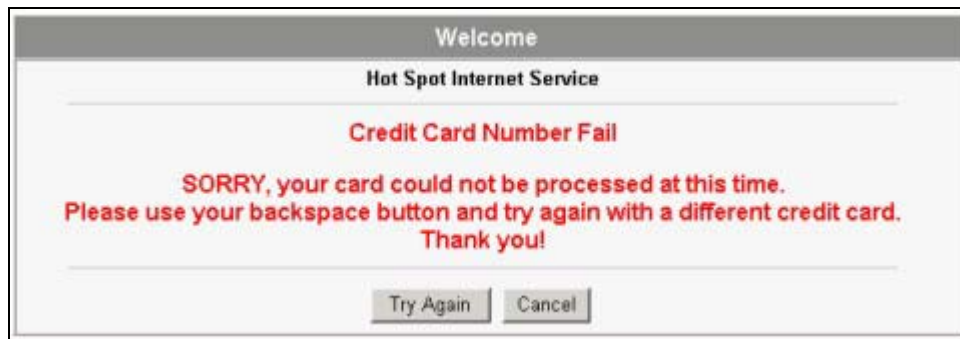

Figure 11-24 Credit Card Failed Page Preview

Chapter 12

Pass Through

This chapter shows you how to specify devices that can have traffic pass through the ZyAIR.

12.1 About the Pass Through

You can set up two types of pass through on the ZyAIR: by device or by web site address.

You can set the ZyAIR to allow specific computers on the LAN (based on the IP or MAC address) to access the Internet without prompting for a user name and password. This feature is useful, for example, if you want to set up computers to provide free Internet access in the VIP room or for sponsors in events.

To allow global access to web sites, specify the web site address (by IP address or URL) that any user can access without logging in. This is similar to the walled garden feature, but without displaying the web site link(s) in the subscriber login screen. You have to inform the users about which web sites they can access for free.

12.2 Configuring Pass Through

To configure pass through on the ZyAIR, click **ADVANCED** and then **PASS THROUGH**.



Pass through has priority over filtering.

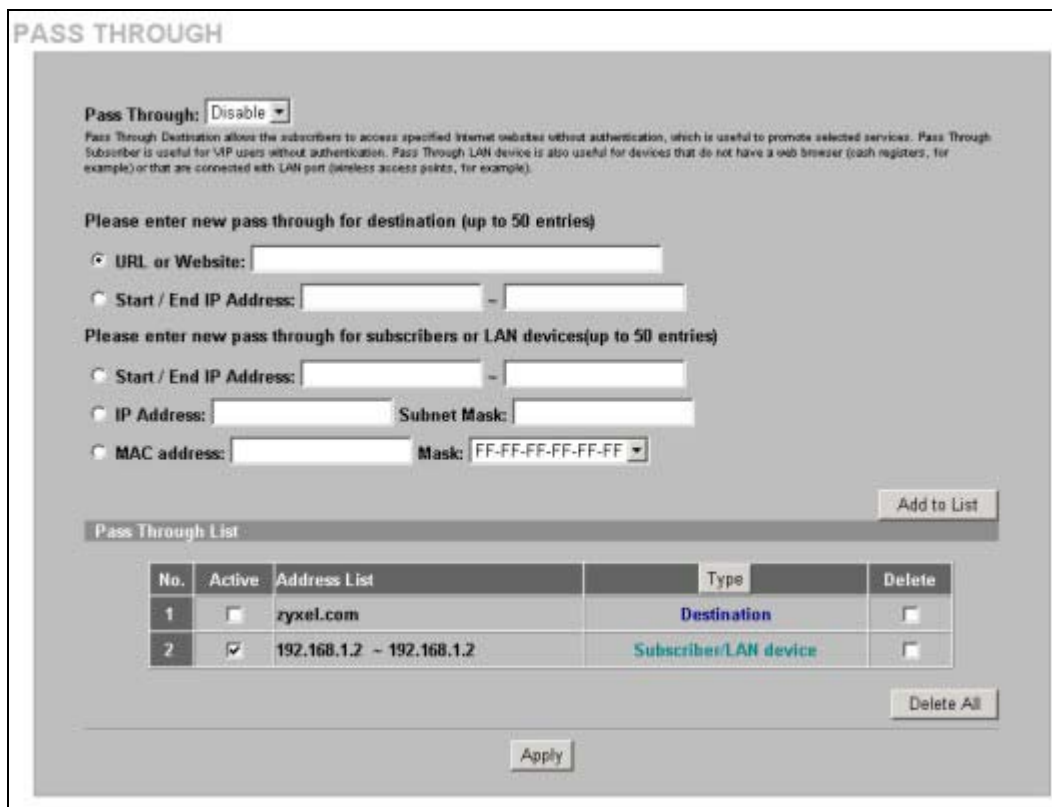

Figure 12-1 PASS THROUGH

The following table describes the labels in this screen.

Table 12-1 PASS THROUGH

LABEL	DESCRIPTION
Pass Through	Enable pass through to allow all users to access specific web sites (or IP addresses) and/or allow packets from specific computers to go through the ZyAIR without prompting for a user name and password.
Please enter new pass through for destination (up to 50 entries) The destinations should be on the WAN.	
URL or Website	Select this option to allow users to access a website without entering a user name or password. Enter the URL (up to 50 ASCII characters) of the web site to which you want to allow access.
Start / End IP Address	Select this option to allow users to access a range of IP addresses without entering a user name or password. Enter the beginning and ending IP addresses in dotted decimal notation.
Please enter new pass through for subscribers or LAN devices (up to 50 entries)	
Start / End IP Address	Select this option to allow packets from computers with a specific range of IP addresses to pass through the ZyAIR without entering a user name and password. Enter the beginning and ending IP addresses IP addresses in dotted decimal notation, for example, 192.168.1.10.

Table 12-1 PASS THROUGH

LABEL	DESCRIPTION
IP Address	Select this option to allow packets from a computer with a specific IP address to pass through the ZyAIR without entering a user name and password. You can specify a range of IP addresses on a network by specifying an IP address here and a subnet mask in the Subnet Mask field. Enter the IP address in dotted decimal notation, for example, 192.168.1.10.
Subnet Mask	Enter the subnet mask of the IP address that you entered in the IP Address field.
MAC Address	Select this option to allow packets from a computer with a specific MAC address to pass through the ZyAIR without entering a user name and password. Enter the MAC address of a computer (in 6 hexadecimal pairs separated by a hyphen "-", for example, 00-50-BA-8D-22-96).
Mask	Enter the subnet mask of the MAC address that you entered in the MAC Address field.
Add to List	Click this button to add the pass through entry you configured to the Pass Through List .
Pass Through List This table displays the device and web site address entries that you have set up on the ZyAIR.	
No.	This read-only field displays the index number of a pass through entry.
Active	Select this check box to turn on this pass through entry and allow access without a user name and password. Clear this check box to turn off this pass through entry and block access without a user name and password.
Address List	This read-only field displays the address(es) of a pass through entry.
Type	This read-only field displays "Destination" for a pass through entry based on a destination URL or IP address. The field displays "Subscriber/LAN device" for a pass through entry based on a LAN device or a subscriber's computer. Click the column heading to sort the pass through entries by type (Destination or Subscriber/LAN device).
Delete	Select this check box(es) and click Apply to remove the pass through entry.
Delete All	Click this button to remove all of the pass-through entries.
Apply	Click Apply to save the new settings.

Chapter 13

Filtering

This chapter shows you how to configure the ZyAIR's filter function.

13.1 About Filtering

Filtering allows you to block subscriber access to a list of destinations. This lets you block access to specific Internet websites or IP addresses. An example of what this would be useful for is blocking access to sites where subscribers would use large amounts of bandwidth for large file downloads or file sharing.

13.2 Configuring Filtering

To configure filtering on the ZyAIR, click **ADVANCED, FILTERING** to display the screen as shown next.



Pass through has priority over filtering.

FILTERING

Filtering:

Filtering allows the system administrator to have a list of restricted destinations, which is useful to block specified Internet websites or Intranet areas.

HTTP Message to display when a website is blocked

Please enter new restricted destination (up to 50 entries)

URL or Website:

Start / End IP Address: -

IP Address: **Subnet Mask:**

Restricted Destination List

No.	Active	Address List	Delete

Figure 13-1 FILTERING

The following table describes the related labels.

Table 13-1 FILTERING

LABEL	DESCRIPTION
Filtering	Enable filtering to block subscriber access to specified Internet websites or IP addresses.
HTTP Message to display when a website is blocked	Enter a message to display on the subscriber's screen when the system blocks access to a website. The default message is "This Web Site is blocked by System".
Please enter new restricted destination (up to 50 entries)	Use these fields to add to the list of forbidden destinations.
URL or Website	Enter the full URL of the website to which you want to block subscriber access for example, "http://www.yahoo.com". You can use up to 200 characters.
Start / End IP Address	Enter the beginning and ending IP addresses of a range of IP addresses to which you want to block subscriber access.
IP Address	Enter an IP address to which you want to block subscriber access.
Subnet Mask	Enter the subnet mask of the IP address to which you want to block subscriber access.
Add to List	Click this button to add a new entry to the list of restricted destinations.
Restricted Destination List	This table lists Internet destinations to which the system is to block subscriber access.
No	This is the index number of a destination entry.
Active	Select this check box to block subscriber access to this destination.
Address List	This field displays the destination address(s).
Delete	Select this(ese) checkbox(es) and click Apply to remove the destination entry.
Delete All	Click this button to remove all of the destination entries.
Apply	Click Apply to save the new settings.

Chapter 14

Share

This chapter shows you how to configure the ZyAIR for the sharing of network devices.

14.1 About Share

The share function allows logged-in subscribers to share devices on the LAN. This is useful for allowing subscribers to use printers or servers.

14.2 Configuring Share

To configure sharing on the ZyAIR, click **ADVANCED**, **SHARE** to display the screen as shown next.

Figure 14-1 SHARE

The following table describes the related labels.

Table 14-1 SHARE

LABEL	DESCRIPTION
Share LAN resource	Enable the sharing of LAN resources to allow logged-in subscribers to access specific devices on the LAN. Disable the sharing of LAN resources to block logged-in subscribers from accessing devices on the LAN.

Table 14-1 SHARE

LABEL	DESCRIPTION
Resource Name	Enter the LAN device's name (up to 50 ASCII characters).
Resource IP Address	Enter the IP address of the LAN device.
Resource MAC Address	Enter the MAC address of the LAN device.
Interface	Select the ZyAIR's interface to which the LAN device is connected.
Add to List	Click this button to add the LAN device information to the list below.
Share LAN resource List	
No.	The index number of share LAN device.
Active	Select or clear this check box to enable or disable the sharing of access to the LAN device.
Resource Name	This field displays the LAN device's name. Click the column heading to sort the entries by resource name.
IP Address	This field displays the IP address of the LAN device. Click the column heading to sort the entries by IP address.
MAC Address	This field displays the MAC address of the LAN device. Click the column heading to sort the entries by MAC address.
Interface	This field displays to which of the ZyAIR's interfaces the LAN device is connected. Click the column heading to sort the entries by interface.
Delete	Select a checkbox(es) and click Apply to delete the share device entry(es).
Delete All	Click this button to remove all of the share device entries.
Apply	Click Apply to save the changes.

Part IV:

Advanced Subscriber Account Management 2

This part covers the **ADVANCED PORTAL PAGE, ADVERTISEMENT, WALLED GARDEN, DDNS, LAN DEVICES, SYSLOG, SESSION TRACE, BANDWIDTH** and **WIRELESS** screens.

Chapter 15

Portal Page, Advertisement Links and Walled Garden

This chapter shows you how to set a portal web site, advertisement links and create walled garden web sites.

15.1 Portal Page Advertisement Links and Walled Garden Overview

When you enable subscriber authentication in the **Authentication Configuration** screen, you can set the ZyAIR to redirect a subscriber to a portal web site, display advertisement links or activate the walled garden feature for generating on-line advertising revenue.

15.2 Portal Page

A portal page is the first web site to which a subscriber is redirected after logging in successfully. The super user account also gets redirected to the portal page. Users are also redirected to this web site if you set up the ZyAIR to not require authentication or to require the acceptance of a user agreement before allowing Internet access. If you do not specify a portal web site, the subscriber will be directed to the intended web site specified.

Click **ADVANCED** and **PORTAL PAGE** to display the screen as shown next.

Figure 15-1 PORTAL PAGE

The following table describes the labels in this screen.

Table 15-1 PORTAL PAGE

LABEL	DESCRIPTION
URL Link	Enter the web site address of a portal page.
Apply	Click Apply to save the settings.

15.3 Advertisement Links

You can set the ZyAIR to display an advertisement web page as the first web page whenever the subscriber connects to the Internet. Click **ADVANCED** and **ADVERTISEMENT** to display the screen as shown next.

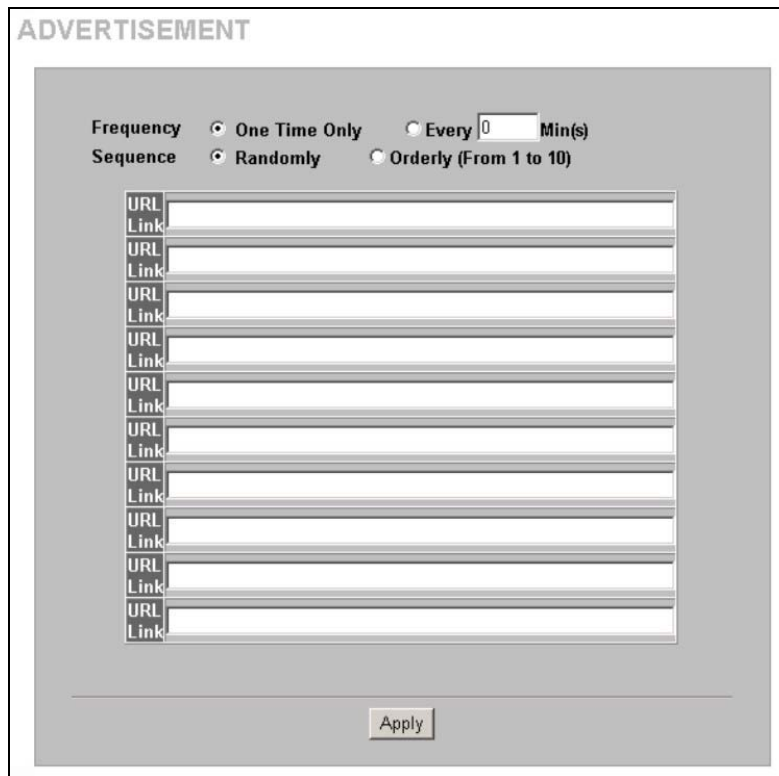



Figure 15-2 ADVERTISEMENT

The following table describes the labels in this screen.

Table 15-2 ADVERTISEMENT

LABEL	DESCRIPTION
Frequency	Select One Time Only to display an advertisement web site in an active browser window once after a subscriber logs in successfully. Select Every ... Min(s) to display an advertisement web site in an active browser window once every time period specified (in minutes) after a subscriber logs in successfully. <hr/>  <p style="text-align: center;">The advertisement links are displayed randomly one at a time.</p> <hr/>
URL Link	Enter the web site addresses in the fields provided.
Apply	Click Apply to save the changes.

15.4 Walled Garden

A subscriber must log in before the ZyAIR allows the subscriber access to the Internet. However, with a walled garden, you can define one or more web site addresses that all subscribers can access without logging in.

Click **ADVANCED SETUP** and then **WALLED GARDEN** to display the screen as shown.

Figure 15-3 WALLED GARDEN

The following table describes the labels in this screen.

Table 15-3 WALLED GARDEN

LABEL	DESCRIPTION
Link 1 ... 10	In the Name field, enter a descriptive name (up to 80 characters) for the walled garden link to be displayed in the web browser. In the URL field, enter the web site address (up to 200 characters) of the web site.
Apply	Click Apply to save the changes.

15.4.1 Walled Garden Login Example

The following figure shows the subscriber login screen with four walled garden links (the links are named **Walled Garden Link 1** through **4** for demonstration purposes, see *Table 15-3* to configure your own custom link names).

The screenshot shows a web interface for a Walled Garden. At the top, there is a dark grey header with the word "Welcome" in white. Below the header, the text "Hot Spot Internet Service" is displayed in green. The main content area is enclosed in a thin blue border and contains a login form. The form has two rows: the first row is labeled "Username:" in green and has an empty text input field; the second row is labeled "Password:" in green and has an empty text input field. Below the input fields, there are two buttons: "Enter" and "Cancel", both with a blue gradient. At the bottom of the form, there are four blue links stacked vertically: "Walled Garden Link 1", "Walled Garden Link 2", "Walled Garden Link 3", and "Walled Garden Link 4".

Figure 15-4 Walled Garden Login Example

Chapter 16

DDNS

This chapter shows you how to set the ZyAIR to use DDNS.

16.1 About DDNS

DDNS (Dynamic Domain Name System) allows you to update your dynamic IP address with one or many dynamic DNS services so that anyone can contact you (in NetMeeting, CU-SeeMe or other services). This is for cases where the ISP gives the ZyAIR a dynamic IP address but you still want to use a domain name. You can also access your FTP server or Web site on your own computer using a domain name (for example, myhost.dhs.org, where myhost is a name of your choice), which will never change instead of using an IP address that changes each time you reconnect.



You must go to the Dynamic DNS service provider's website and register a user account and a domain name before you can use the Dynamic DNS service with your ZyAIR.

The Dynamic DNS service provider will give you a password or key.



If you have a private WAN IP address, then you cannot use Dynamic DNS.

16.1.1 DYNDNS Wildcard

Enabling the wildcard feature for your host causes *.yourhost.dyndns.org to be aliased to the same IP address as yourhost.dyndns.org. This feature is useful if you want to be able to use, for example, www.yourhost.dyndns.org and still reach your hostname.

16.2 Configuring DDNS

Click **ADVANCED** and **DDNS** to display the screen as shown next.

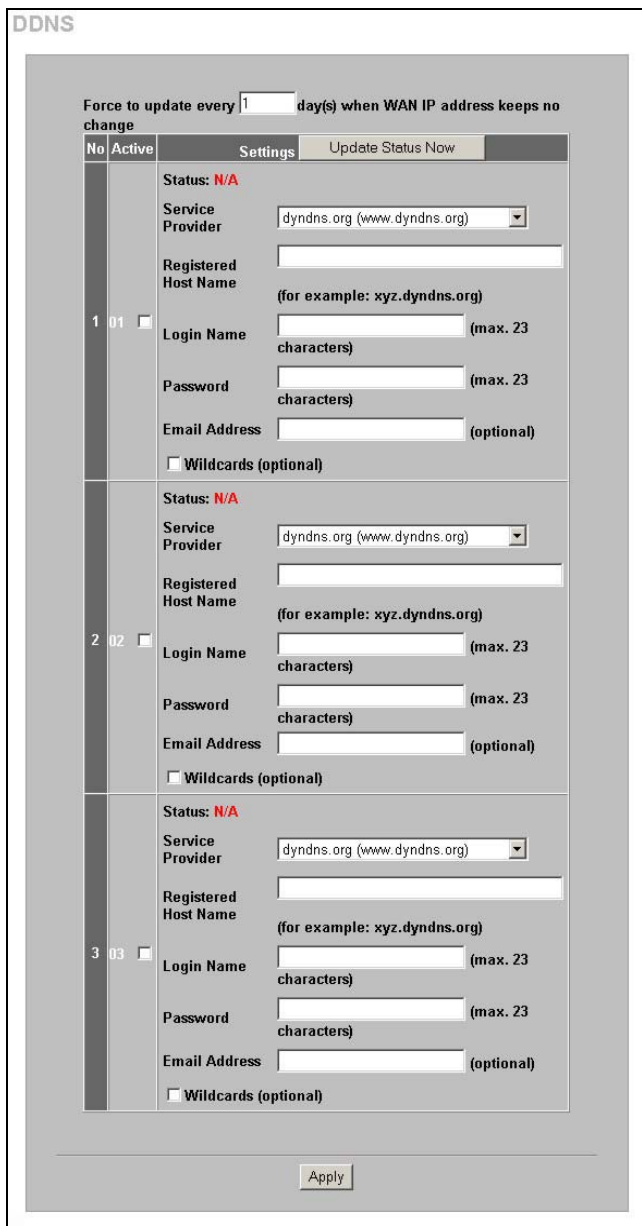

Figure 16-1 DDNS

The following table describes the labels in this screen.

Table 16-1 DDNS

LABEL	DESCRIPTION
Force to update every ~day(s) when WAN IP address keeps no change	Enter a number in the field to set the force update interval (in days). This sets how often the ZyAIR updates the DDNS server with the ZyAIR's WAN IP address when the ZyAIR's WAN IP address stays the same.
No	This is the index number of a DDNS account.
Active	Select or clear the check box to enable or disable the DDNS record.

Table 16-1 DDNS

LABEL	DESCRIPTION
Update Status Now	Click the Update Status Now button to have the ZyAIR update the DDNS server with the ZyAIR's WAN IP address.
Settings	Enter the DDNS server account information in the fields below.
Status	<p>This field displays N/A when the DDNS client service is not installed.</p> <p>This field displays the time of the latest update (in YY/MM/DD HH:MM:SS format) and the current state of the DDNS Client.</p> <p>This field displays Updated Successfully when the DDNS client service is installed and running.</p> <p>This field displays Update Fail when the DDNS client service is installed, but the service is not running.</p>
Service Provider	Select the name of your Dynamic DNS service provider.
Registered Host Name	Enter the host name in the field provided.
Login Name	Enter the user name for the above Registered Host Name . The Dynamic DNS service provider assigns you this user name.
Password	Enter the password for the above Login Name . The Dynamic DNS service provider assigns you this password.
Email Address	Enter your e-mail address. The DDNS server e-mails you important information once your Internet Name has been successfully registered.
Wildcards (optional)	Select the check box to enable DYNDNS Wildcard.
Apply	Click Apply to save the changes.

Chapter 17

LAN Devices

This chapter describes how you can remotely access devices on the LAN through the ZyAIR.

17.1 LAN Devices and NAT Overview

NAT (Network Address Translation - NAT, RFC 1631) is the translation of the IP address of a host in a packet. For example, the source address of an outgoing packet, used within one network is changed to a different IP address known within another network.

Traditionally, when you have a device (for example, a switch) on a LAN using NAT, you cannot access the device from the WAN since the LAN device is assigned a private IP address.

Your ZyAIR is a NAT-enabled device that makes your whole inside network appear as a single computer to the outside world.

17.1.1 Port Mapping

To make LAN devices behind the ZyAIR visible to the outside world, you configure a mapping between a virtual port on the ZyAIR and a server port on a LAN device. A virtual port is a port on the ZyAIR that appears as a physical port to the attached devices. A server port defines a server to which all specified requests are forwarded.

In addition, centralized LAN device management is possible through the ZyAIR using port mapping. You can access the management interface on the LAN device remotely provided that the LAN device has allowed remote management.

17.2 Configuring LAN Devices Port Mapping

Click **ADVANCED** and **LAN DEVICES** to display the screen as shown next.



You can configure port mapping for up to 50 LAN devices on the ZyAIR.

LAN DEVICES

Accommodate up to 50 entries

Polling Interval: (min)

No.	Device Name	Virtual Port (60001~60050)	Device IP Address	Device Server Port	Device MAC Address	Application	Interface
1	<input type="text"/>	<input type="text" value="0"/>	<input type="text"/>	<input type="text" value="0"/>	<input type="text"/>	TCP ▾	Wired ▾
2	<input type="text"/>	<input type="text" value="0"/>	<input type="text"/>	<input type="text" value="0"/>	<input type="text"/>	TCP ▾	Wired ▾
3	<input type="text"/>	<input type="text" value="0"/>	<input type="text"/>	<input type="text" value="0"/>	<input type="text"/>	TCP ▾	Wired ▾
4	<input type="text"/>	<input type="text" value="0"/>	<input type="text"/>	<input type="text" value="0"/>	<input type="text"/>	TCP ▾	Wired ▾
5	<input type="text"/>	<input type="text" value="0"/>	<input type="text"/>	<input type="text" value="0"/>	<input type="text"/>	TCP ▾	Wired ▾
6	<input type="text"/>	<input type="text" value="0"/>	<input type="text"/>	<input type="text" value="0"/>	<input type="text"/>	TCP ▾	Wired ▾
7	<input type="text"/>	<input type="text" value="0"/>	<input type="text"/>	<input type="text" value="0"/>	<input type="text"/>	TCP ▾	Wired ▾
8	<input type="text"/>	<input type="text" value="0"/>	<input type="text"/>	<input type="text" value="0"/>	<input type="text"/>	TCP ▾	Wired ▾
9	<input type="text"/>	<input type="text" value="0"/>	<input type="text"/>	<input type="text" value="0"/>	<input type="text"/>	TCP ▾	Wired ▾
	<input type="text"/>	<input type="text" value="0"/>	<input type="text"/>	<input type="text" value="0"/>	<input type="text"/>	TCP ▾	Wired ▾

Notice: The system does not support FTP

Figure 17-1 LAN DEVICES

The following table describes the labels in this screen.

Table 17-1 LAN DEVICES

LABEL	DESCRIPTION
Polling Interval	Specify the time interval (in minutes) between the ZyAIR's probes for device availability.
No.	This read-only field displays the index number of an entry.
Device Name	Enter the name (up to 20 characters) of the LAN device for identification purposes.
Virtual Port	Enter a unique port number between 60001 and 60050 to map to the port number in the Server Port field.
Device IP Address	Enter the IP address of a LAN device in dotted decimal notation. For example, 192.168.1.40.
Device Server Port	Enter the port number for a service (for example, 80 for HTTP) on the LAN device.
MAC Address	Enter the MAC address of the LAN device in hexadecimal notation in 6 hexadecimal pairs, for example, 0050BA8D2296. Make sure you enter the correct MAC address.
Application	Select an application type from the drop-down list box. Choose from TCP or UDP . Only requests for the selected application type are forwarded to the specified server port on the LAN device.
Interface	Select the ZyAIR's interface to which the LAN device is connected.
Delete All	Click Delete All to clear all entries. To delete a single entry, erase the contents in that entry.
Apply	Click Apply to save the changes.

17.2.1 LAN Device Management Example

In this example, there is a manageable switch and a wireless access point behind the ZyAIR and you want to be able to remotely access the web-based management interfaces on the manageable switch (on the left) and access point over the Internet.

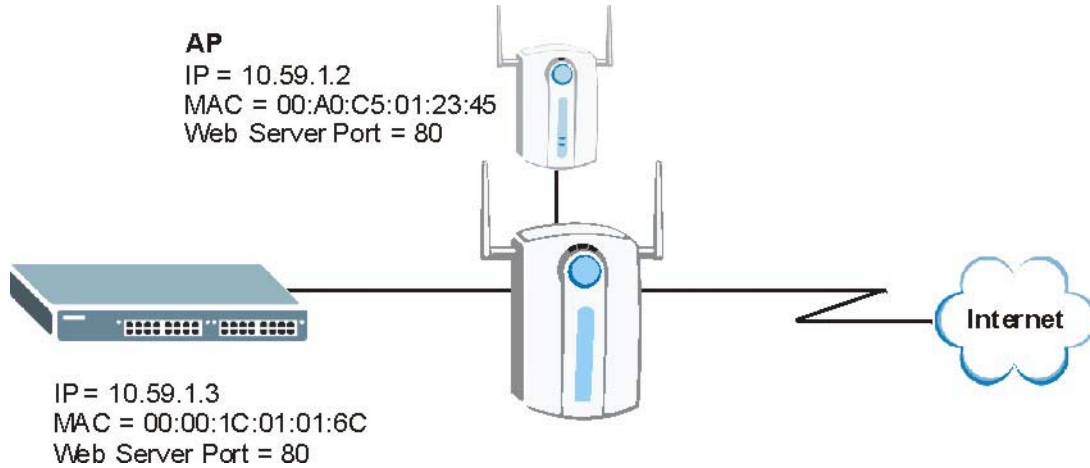

Figure 17-2 LAN Device Remote Management Example 1

You map virtual port 60001 on the ZyAIR to the web server port on the access point and 60002 to the web server port on the manageable switch.

LAN DEVICES							
Accommodate up to 50 entries							
Polling Interval: <input type="text" value="5"/> (min)							
No.	Device Name	Virtual Port (60001-60050)	Device IP Address	Device Server Port	Device MAC Address	Application	Interface
1	AP	60001	10.59.1.2	80	00A0C5012345	TCP	Wired
2	Switch	60002	10.59.1.3	80	00001C01016C	TCP	Wired
3		0		0		TCP	Wired

Figure 17-3 LAN Devices: Example 1

To access the web-based management interface, enter the WAN IP address of your ZyAIR and the virtual port number of the LAN device separated by a colon. In this example, to access the access point (AP), enter “http:// 192.168.1.1:60001” where 192.168.1.1 is the WAN IP address of the ZyAIR. The login screen of the LAN device management interface should display.

You can also access the LAN devices through the ZyAIR web configurator, refer to the section on accessing the LAN devices for more information.

17.2.2 Specifying an Inside Server Example

Let’s say you have a web server behind the ZyAIR as shown in the next figure.

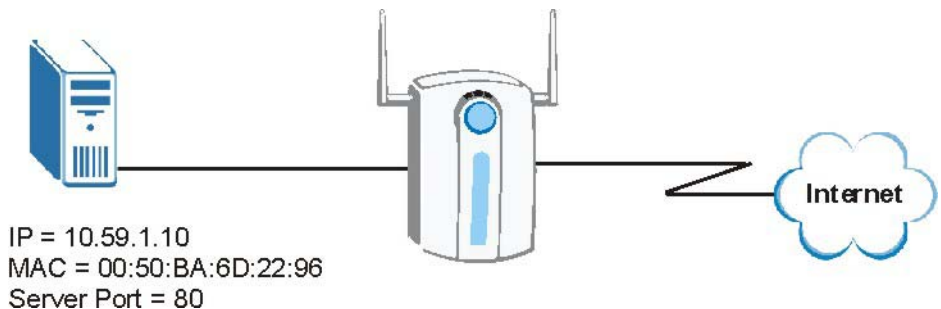

Figure 17-4 LAN Device Remote Management Example 2

In the **LAN Device Management** screen, you map virtual port 60001 to the server port (80) on the web server.

LAN DEVICES							
Accommodate up to 50 entries							
						Polling Interval: <input type="text" value="5"/> (min)	
No.	Device Name	Virtual Port (60001-60050)	Device IP Address	Device Server Port	Device MAC Address	Application	Interface
1	Web Server	60001	10.59.1.10	80	0050BA6D2296	TCP	Wired
2		0		0		TCP	Wired

Figure 17-5 LAN Devices: Example 2

To access an inside server on the LAN, enter the WAN IP address of your ZyAIR and the virtual port number of the inside server separated by a colon. In this example, to access the web server, enter “http:// 192.168.1.1:60001” where 192.168.1.1 is the WAN IP address of the ZyAIR.

You can also access the server by entering the domain name provided that the ZyAIR has a domain name (or a dynamic domain name). Enter the domain name and the virtual port number separated by a colon, for example, http://www.domainName:60001.

You can also access the LAN devices through the ZyAIR web configurator, refer to the section on accessing the LAN devices for more information.

Chapter 18

Syslog

This chapter shows you how to configure syslog on the ZyAIR.

18.1 Syslog Configuration

Use the **SYSLOG Syslog** screen to configure to where the ZyAIR is to send logs.

To configure the syslog settings, click **ADVANCED, SYSLOG** to display the screen as shown next.

Figure 18-1 Syslog

The following table describes the labels in this screen.

Table 18-1 Syslog

LABEL	DESCRIPTION
Send to Syslog Server	Select Enable to activate the syslog function. Select Disable to de-activate the syslog function.
Syslog Server on LAN	Select this check box to specify a syslog server on the LAN.
Server IP Address	Enter the IP address (in dotted decimal notation) of the syslog server on the LAN.
Server MAC Address	Enter the MAC address of the syslog server on the LAN.

Table 18-1 Syslog

LABEL	DESCRIPTION
Syslog Server on WAN	Select this check box to specify a syslog server on the WAN.
Server 1 IP Address	Enter the IP address of the first syslog server on the WAN in dotted decimal notation.
Server 2 IP Address	Enter the IP address of the second syslog server on the WAN in dotted decimal notation.
Send to Email	Select Enable to have the ZyAIR send syslog messages to the e-mail account that you specify. Select Disable to not have the ZyAIR send syslog e-mail messages.
Email Server	
IP Address or Domain Name	Enter the IP address or domain name of the mail server for the e-mail addresses specified below. If this field is left blank, the syslog will not be sent via e-mail.
SMTP Port	Enter the port number (25, or between 2500 and 2599) for the mail server. The default is 25 .
E-mail (SMTP) server needs to check my account	Select this check box if your SMTP server requires user name and password authentication before accepting e-mail. Your network administrator, SMTP server provider or ISP should supply the username and password.
Username	Enter the username for the SMTP server.
Password	Enter the password for the SMTP server.
Email From:	
Name	Type a name that you want to be in the "message from" field of the log e-mail message that the ZyAIR sends.
Email Address	Enter your e-mail address. This is the address others use to send e-mail to Email Address 1/Email Address 2 .
Email To:	
Email Address 1,2	Enter your first and second e-mail addresses to which the ZyAIR is to send the syslog e-mails. If you leave these fields blank, logs will not be sent via e-mail.
Apply	Click Apply to save the settings.

18.2 Syslog Log Settings Configuration

Use the **SYSLOG Log Settings** screen to configure which logs the ZyAIR is to send and the schedule for when the ZyAIR is to send the logs.

Click **ADVANCED, SYSLOG, Log Settings** to display the screen as shown next.

SYSLOG

Syslog Log Settings

System

Syslog	Email	Syslog Name	Description	Interval Time
<input type="checkbox"/>	<input type="checkbox"/>	System Information	A log including the system information will be sent according to specified interval time	60 minutes
<input type="checkbox"/>	<input type="checkbox"/>	System Boot Notice	Once system reboots, the log will be sent	When system reboot
<input type="checkbox"/>	<input type="checkbox"/>	System Manager Activity Information	A log will be sent if system manager (administrator, Supervisor or Account Manager) login to or logout from the device	When system manager login or logout

Subscriber

Syslog	Email	Syslog Name	Description	Interval Time
<input type="checkbox"/>	<input type="checkbox"/>	Wireless Association Information	A log including wireless users information will be sent according to specified interval time	60 minutes
<input type="checkbox"/>	<input type="checkbox"/>	Logged-in Users	A login users information will be sent according to specified interval time	60 minutes

Proprietary Accounting

Syslog	Email	Syslog Name	Description	Interval Time
<input type="checkbox"/>	<input type="checkbox"/>	Account Created	A log will be sent once after an account is created	When an account is created
<input type="checkbox"/>	<input type="checkbox"/>	Account Activated	A log will be sent once after an account is activated	When an account is activated
<input type="checkbox"/>	<input type="checkbox"/>	Subscriber Trace	A log included subscribers login/logout time would be sent once after subscriber logout	When subscriber logout or idle-timeout
<input type="checkbox"/>	<input type="checkbox"/>	User Agreement	A log would be sent when "user agreement" enabled	When subscriber login

Billing

Syslog	Email	Syslog Name	Description	Interval Time
<input type="checkbox"/>	<input type="checkbox"/>	Billing Log	A log would be sent after a billing log is created	When log created

LAN Devices Management

Syslog	Email	Syslog Name	Description	Interval Time
<input type="checkbox"/>	<input type="checkbox"/>	LAN Devices Information	A log included current LAN Devices Status would be sent according to specified interval time	60 minutes
<input type="checkbox"/>	<input type="checkbox"/>	LAN Devices Alarm	A log would be send if one of the LAN Devices detected result is FAIL	When device fail

Apply

Figure 18-2 Log Settings

The following table describes the labels in this screen.

Table 18-2 Log Settings

LABEL	DESCRIPTION
Syslog	Select this check box to send this log information to your syslog server.
Email	Select this check box to send log information to the e-mail address specified in the Syslog screen.
Syslog Name	This field displays the name (or type) of the syslog. Select the checkbox(es) to send the syslog.

Table 18-2 Log Settings

LABEL	DESCRIPTION
Description	This field displays a short description about the syslog.
Interval Time	This field displays how often the ZyAIR sends the syslog. If available, enter the number of minutes the ZyAIR waits between sending the syslog.
Apply	Click Apply to save the settings.

The following table describes the syslog formats.

Table 18-3 Log Formats

SYSLOG NAME	FORMAT	CREATED
System Information	Id <MAC Address> System Uptime <0 days 00h:04m:00s> Location Name <Location Name> WAN <FrameTxOK FrameRxOK FrameTxError FrameRxError> LAN <FrameTxOK FrameRxOK FrameTxError FrameRxError> Wireless <FrameTxOK FrameRxOK FrameTxError FrameRxError>	Each time interval specified (between 1 and 10080 minutes).
System Boot Notice	Id <MAC Address> System Up	Each time the device reboots, w
System Manager Activity Information	Id <MAC Address> System Account Activity Information <Username, User IP, Status> Where: Username = Administrator Supervisor Accounting Operator User IP = IP Address Status = Login Logout Idle Time Out	Each time when a system manager logs in or logs out.
Wireless Association Information	Id <MAC Address> Wireless Association Information <Number of associated users, Start Number, End number> (Signal strength, Signal quality, Connection speed, MAC address>(...)(...)(...)	Each time interval specified (between 1 and 10080 minutes).
Logged-in Users	Id <MAC Address> Logged-in Users <Type, Number of logged-in users, Start Number, End number> Username, User IP, User MAC, Interface, Login time, RxData count, TxData count)(...)(...) Where: Type: Dynamic Super User agreement If the type of Logged-in user is Super Subscriber or User agreement, Username will be "*****".	Each time interval specified (between 1 and 10080 minutes).
Account Created	Id <Mac Address> Account Create <Type, S/N, Username, Unit, Account usage time, Billing profile information> Where: Type: TimeToFinish Accumulation PostPaid Billing profile information = index, name Account usage time: 00:59:59 (example)	When an account is created.
Account Activated	Id <Mac Address> Account Activate < Username, User IP, User MAC, Interface >	When a subscriber account is activated.

Table 18-3 Log Formats

SYSLOG NAME	FORMAT	CREATED																																																			
Subscriber Trace	<p>Id <MAC Address> Subscriber Trace <Type, Event, S/N, Username, User IP, User MAC, Interface, Login time, Logout time, Usage Time, Time Left, RxData count, TxData count></p> <p>Where:</p> <p style="padding-left: 40px;">Type: TimeToFinish Accumulation PostPaid Super</p> <p style="padding-left: 40px;">Event: Finished Replenished Logout Idle-Timeout Account Expired Deleted</p> <p style="padding-left: 40px;">If the type of Subscriber Trace is Super, the Username will be "*****", and S/N will be "*****".</p> <p style="padding-left: 40px;">Usage time: 00:59:59 (example)</p>	When a subscriber logs out.																																																			
	<p style="text-align: center;">Subscriber Trace Relationship</p> <table border="1" style="width: 100%; border-collapse: collapse;"> <thead> <tr> <th data-bbox="461 701 716 747">TYPE</th> <th data-bbox="716 701 964 747">EVENT</th> <th data-bbox="964 701 1203 747">TIME LEFT</th> </tr> </thead> <tbody> <tr> <td>TimeToFinish</td> <td>Finished</td> <td>00:00:00</td> </tr> <tr> <td>TimeToFinish</td> <td>Replenished</td> <td>00:12:00 to S/Nxxxxxx</td> </tr> <tr> <td>TimeToFinish</td> <td>Deleted</td> <td>00:12:00</td> </tr> <tr> <td>Accumulation</td> <td>Finished</td> <td>00:00:00</td> </tr> <tr> <td>Accumulation</td> <td>Replenished</td> <td>00:12:00 to S/Nxxxxxx</td> </tr> <tr> <td>Accumulation</td> <td>Logout</td> <td>00:48:00</td> </tr> <tr> <td>Accumulation</td> <td>Idle-Timeout</td> <td>00:48:00</td> </tr> <tr> <td>Accumulation</td> <td>Deleted</td> <td>00:48:00</td> </tr> <tr> <td>Accumulation</td> <td>Account Expired</td> <td>00:48:00</td> </tr> <tr> <td>PostPaid</td> <td>Logout</td> <td>*****</td> </tr> <tr> <td>PostPaid</td> <td>Idle-Timeout</td> <td>*****</td> </tr> <tr> <td>PostPaid</td> <td>Deleted</td> <td>*****</td> </tr> <tr> <td>PostPaid</td> <td>Finished</td> <td>*****</td> </tr> <tr> <td>PostPaid</td> <td>Account Expired</td> <td>*****</td> </tr> <tr> <td>Super</td> <td>Idle-Timeout</td> <td>*****</td> </tr> <tr> <td>Super</td> <td>Deleted</td> <td>*****</td> </tr> </tbody> </table>	TYPE	EVENT	TIME LEFT	TimeToFinish	Finished	00:00:00	TimeToFinish	Replenished	00:12:00 to S/Nxxxxxx	TimeToFinish	Deleted	00:12:00	Accumulation	Finished	00:00:00	Accumulation	Replenished	00:12:00 to S/Nxxxxxx	Accumulation	Logout	00:48:00	Accumulation	Idle-Timeout	00:48:00	Accumulation	Deleted	00:48:00	Accumulation	Account Expired	00:48:00	PostPaid	Logout	*****	PostPaid	Idle-Timeout	*****	PostPaid	Deleted	*****	PostPaid	Finished	*****	PostPaid	Account Expired	*****	Super	Idle-Timeout	*****	Super	Deleted	*****	
TYPE	EVENT	TIME LEFT																																																			
TimeToFinish	Finished	00:00:00																																																			
TimeToFinish	Replenished	00:12:00 to S/Nxxxxxx																																																			
TimeToFinish	Deleted	00:12:00																																																			
Accumulation	Finished	00:00:00																																																			
Accumulation	Replenished	00:12:00 to S/Nxxxxxx																																																			
Accumulation	Logout	00:48:00																																																			
Accumulation	Idle-Timeout	00:48:00																																																			
Accumulation	Deleted	00:48:00																																																			
Accumulation	Account Expired	00:48:00																																																			
PostPaid	Logout	*****																																																			
PostPaid	Idle-Timeout	*****																																																			
PostPaid	Deleted	*****																																																			
PostPaid	Finished	*****																																																			
PostPaid	Account Expired	*****																																																			
Super	Idle-Timeout	*****																																																			
Super	Deleted	*****																																																			
User Agreement	<p>(Id, Mac Address) (User Agreement, Type, User IP, User MAC)</p> <p>Where:</p> <p style="padding-left: 40px;">Type: Agree Do not agree</p>	When "user agreement" is enabled.																																																			

Table 18-3 Log Formats

SYSLOG NAME	FORMAT	CREATED
Billing Log	<p>Id <Mac Address> Billing Log <, Type, S/N, Username, Billing profile information, Units, Usage time, Bill, Payment></p> <p>Where:</p> <p style="padding-left: 40px;">Type: TimeToFinish Accumulation PostPaid</p> <p style="padding-left: 40px;">Billing profile name: [Name]</p> <p style="padding-left: 40px;">Usage time: "00:59:59" (example)</p> <p style="padding-left: 40px;">Billing profile information = index, name</p> <p style="padding-left: 40px;">Payment: Cash Credit Card</p> <p style="padding-left: 40px;">"Credit Card" does not support "PostPaid".</p> <p style="padding-left: 40px;">If Type is "PostPaid", the billing profile information and Units will be "**".</p>	When a billing log is created
LAN Devices Information	Id <MAC Address> LAN Devices Information <Number of devices, Start Number, End number> Device name <status> [additional information]	Each time interval specified (between 1 and 10080 minutes).
LAN Devices Alarm	Id <MAC Address> LAN Device Alarm <Device name, FAIL>	When the ZyAIR cannot connect to an attached LAN device.

Chapter 19

Session Trace

This chapter shows you how to configure the ZyAIR's session trace feature.

19.1 Session Trace

You can set the ZyAIR to send session information of subscribers accessing the Internet. The ZyAIR records the session information and stores it temporary. Once the session trace information reaches 50 records or the specified time period is reached, the ZyAIR sends the session information to the specified TFTP server.

19.2 Session Trace Configuration

Use the **SESSION TRACE** screen to configure to the ZyAIR to record details about subscriber Internet access and send logs of the session traces to a TFTP server.

To configure the session trace settings, click **ADVANCED**, **SESSION TRACE** to display the screen as shown next.

SESSION TRACE

Session Trace:

Primary TFTP Server IP Address

Secondary TFTP Server IP Address

Send Session Trace log file every minutes. (5 ~ 1440)

(Note: Session Trace log file will be sent also when collected 50 logs)

Figure 19-1 SESSION TRACE

The following table describes the labels in this screen.

Table 19-1 SESSION TRACE

LABEL	DESCRIPTION
Session Trace	Enable the session trace feature to record the destination IP address, destination port, source IP address, source MAC address and source port of every subscriber session. The ZyAIR sends the collected information in a text file to the TFTP server that you specify. Disable the session trace feature to not record and send details about the Internet access activity of your subscribers.
Primary TFTP Server IP Address	Enter the IP address of the first TFTP server in dotted decimal notation.
Secondary TFTP Server IP Address	Enter the IP address of the second TFTP server in dotted decimal notation.
Send Session Trace log file every~ minutes.	Enter the time interval (minutes) for how often you want the ZyAIR to send the session trace log file. <hr/> <div style="text-align: center;">  <p>The ZyAIR will also automatically send the log file whenever the log has 50 entries.</p> </div> <hr/> The ZyAIR clears the session trace record after sending a log file.
Apply	Click Apply to save the settings.

19.3 Session Trace Filename Convention

The subscriber session information is stored a plain text file with a “txt” filename extension. The general structure of the filename is <hostname>DDMMYYHHMMSS.txt. For example, “MIS221004131543.txt” is the file name of a session information file created at 13:15:43 PM on October 22, 2004 on a ZyAIR with a hostname of “MIS”.

You can view the subscriber session trace information using any text editor. The following figure shows an example of the session information file the ZyAIR sends to a TFTP server.

Host Name	User Name	Date	SourceIP	SourceMac	SourcePort	DestIP	DestPor
MyDevice	79mv9r33	16Aug05165501	192.168.1.2	000FFE1E4AE0	2101	66.102.7.147	80
MyDevice	79mv9r33	16Aug05165517	192.168.1.2	000FFE1E4AE0	2104	168.95.1.1	53
MyDevice	79mv9r33	16Aug05165517	192.168.1.2	000FFE1E4AE0	2105	69.44.58.78	80

Figure 19-2 Session Trace Information Example

The following table describes the fields in a session information file.

Table 19-2 Session Trace File Fields

FIELD	DESCRIPTION
Host Name	This is the host (or system) name of the ZyAIR.
User Name	This is the subscriber account username. This field is empty if you disable authentication in the Authentication screen (see Chapter 6, "Authentication," on page 69 for more information).
Date	This is the date and time the ZyAIR creates a session trace record.
SourceIP	This is the IP address of the subscriber.
SourceMac	This is the MAC address of the subscriber's computer.
SourcePort	This is the source port number of the subscriber.
DestIP	This is the destination IP address the subscriber accesses.
DestPort	This is the destination port number for this session.

Chapter 20

Bandwidth

This chapter shows you how to configure the ZyAIR's bandwidth management feature.

20.1 Bandwidth

You can set the ZyAIR to limit the amount of bandwidth each user can use. This prevents one user from consuming a disproportionately large amount of bandwidth and helps ensure that every user gets their fair share. If there is a lot of unused bandwidth, however, this feature is not necessary and slows down users who could use the extra bandwidth to upload or download large amounts of information more quickly.

The ZyAIR separates bandwidth into upstream bandwidth and downstream bandwidth. Upstream bandwidth is used when users send information to the WAN, and downstream bandwidth is used when users receive information from the WAN. This distinction is helpful when you might want to set limits one way but not the other. For example, if your users download a lot of MP3 files, you might set a limit on downstream bandwidth but not set a limit on upstream bandwidth. In other situations, however, you might put the same limit on upstream and downstream bandwidth.

20.2 Bandwidth Configuration

Use the **BANDWIDTH** screen to configure to the ZyAIR to limit the amount of upstream and downstream bandwidth each user can use.

To configure the bandwidth settings, click **ADVANCED**, **BANDWIDTH** to display the screen shown next.

BANDWIDTH

Bandwidth Management:

The function enables administrator to limit bandwidth usage on a per user basis (MAC address). That prevents users from consuming a disproportionately large amount of bandwidth so every user gets a fair share of the available bandwidth.

Please setup the maximum Upstream/Downstream bandwidth

Maximum Upstream 64Kbps Kbps (1~5120)

Maximum Downstream 64Kbps Kbps (1~5120)

Figure 20-1 BANDWIDTH

The following table describes the labels in this screen.

Table 20-1 BANDWIDTH

LABEL	DESCRIPTION
Bandwidth Management	Select Enable to turn on bandwidth management. If you select Disable , each user gets as much bandwidth as possible until the available bandwidth is gone.
Maximum Upstream	Select the maximum amount of upstream (outbound) bandwidth or enter a specific amount of bandwidth in Kbps that any user can have.
Maximum Downstream	Select the maximum amount of downstream (inbound) bandwidth or enter a specific amount of bandwidth in Kbps that any user can have.
Apply	Click Apply to save the settings.

Chapter 21

Wireless LAN

This chapter shows you how to configure wireless LAN settings on the ZyAIR and set up WEP encryption keys.

21.1 Wireless LAN Overview

This section introduces the wireless LAN (WLAN) and some basic scenarios.

21.1.1 IBSS

An Independent Basic Service Set (IBSS), also called an Ad-hoc network, is the simplest WLAN configuration. An IBSS is defined as two or more computers with wireless adapters within range of each other and can set up an independent (wireless) network without the need of an access point (AP).

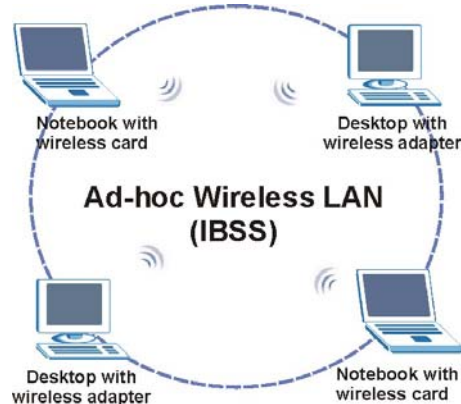

Figure 21-1 IBSS (Ad-hoc) Wireless LAN

21.1.2 BSS

A Basic Service Set (BSS) is when all communications between wireless stations or between a wireless station and a wired network client go through one access point (AP).

Intra-BSS traffic is traffic between wireless stations in the BSS.

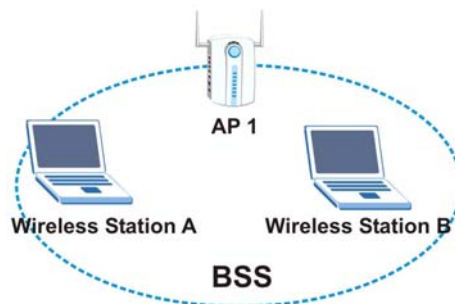

Figure 21-2 Basic Service set

21.1.3 ESS

An Extended Service Set (ESS) consists of a series of overlapping BSSs, each containing an access point, with each access point connected together by a wired network. This wired connection between APs is called a Distribution System (DS). An ESSID (ESS IDentification) uniquely identifies each ESS. All access points and their associated wireless stations within the same ESS must have the same ESSID in order to communicate.

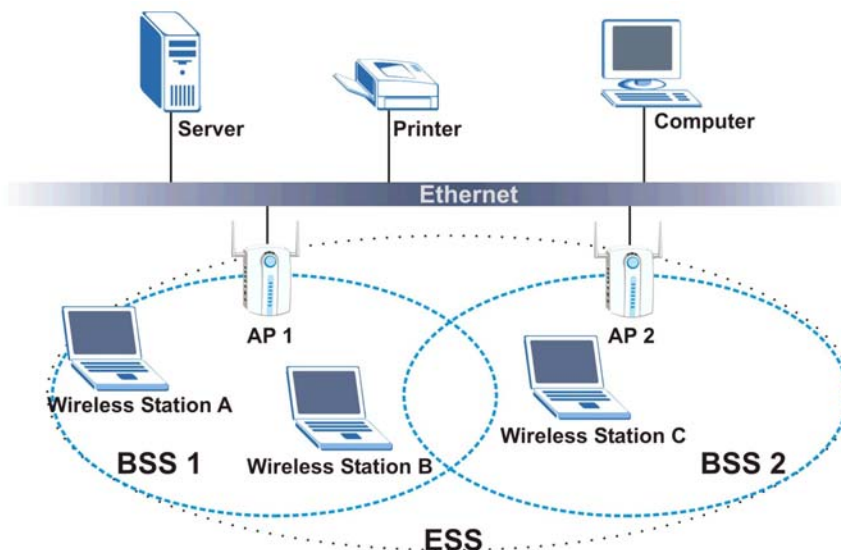

Figure 21-3 Extended Service Set

21.2 Wireless LAN Basics

This section provides background information on Wireless LAN features.

21.2.1 Wireless Standards

The ZyAIR complies with the IEEE 802.11g wireless standard and is also fully compatible with the 802.11b standard. This means an IEEE 802.11b radio card can interface directly with an IEEE 802.11g device (and vice versa) at 11 Mbps or lower depending on range. The IEEE 802.11b data rate and corresponding modulation techniques are shown in the table below. The modulation technique defines how bits are encoded onto radio waves.

Table 21-1 IEEE 802.11b Data Rates and Modulation

DATA RATE (MBPS)	MODULATION
1	DBPSK (Differential Binary Phase Shift Keyed)
2	DQPSK (Differential Quadrature Phase Shift Keying)
5.5 / 11	CCK (Complementary Code Keying)

IEEE 802.11g has several intermediate rate steps between the maximum and minimum data rates. The IEEE 802.11g data rate and modulation are as follows:

Table 21-2 IEEE 802.11g Data Rates and Modulation

DATA RATE (MBPS)	MODULATION
6/9/12/18/24/36/48/54	OFDM (Orthogonal Frequency Division Multiplexing)



The ZyAIR may be prone to RF (Radio Frequency) interference from other 2.4 GHz devices such as microwave ovens, wireless phones, Bluetooth enabled devices, and other wireless LANs.

21.2.2 Wireless LAN Coverage

The following table shows the ZyAIR's coverage (in meters) using the included antennas. The distance may differ depending on the network environment.

Table 21-3 Wireless LAN Coverage

	≤11 Mbps	≤ 5.5 Mbps
Indoor	50 m	80 m
Outdoor	200 m	300 m

21.2.3 Channel

A channel is the radio frequency(ies) used by IEEE 802.11g wireless devices. Channels available depend on your geographical area. You may have a choice of channels (for your region) so you should use a different channel than an adjacent AP (access point) to reduce interference. Interference occurs when radio signals from different access points overlap causing interference and degrading performance.

Adjacent channels partially overlap however. To avoid interference due to overlap, your AP should be on a channel at least five channels away from a channel that an adjacent AP is using. For example, if your region has 11 channels and an adjacent AP is using channel 1, then you need to select a channel between 6 and 11.

21.2.4 Introduction to WPA

Wi-Fi Protected Access (WPA) is a subset of the IEEE 802.11i standard. Key differences between WPA and WEP are user authentication and improved data encryption. WPA applies IEEE 802.1x and Extensible Authentication Protocol (EAP) to authenticate wireless clients using an external RADIUS database. You can't use the ZyAIR's Local User Database for WPA authentication purposes since the Local User Database uses EAP-MD5, which cannot be used to generate keys.

WPA improves data encryption by using Temporal Key Integrity Protocol (TKIP), Message Integrity Check (MIC) and IEEE 802.1x. Temporal Key Integrity Protocol (TKIP) uses 128-bit keys that are dynamically generated and distributed by the authentication server. It includes a per-packet key mixing function, a Message Integrity Check (MIC) named Michael, an extended initialization vector (IV) with sequencing rules, and a re-keying mechanism.

21.2.5 WEP Encryption

WEP (Wired Equivalent Privacy) encrypts data frames before transmitting over the wireless network. WEP encryption scrambles the data transmitted between the wireless stations and the access points to keep network communications private. It encrypts unicast and multicast communications in a network.

Both the wireless stations and the access points must use the same WEP key for data encryption and decryption.
 WEP degrades performance.

21.2.6 RTS/CTS

A hidden node occurs when two stations are within range of the same access point, but are not within range of each other. The following figure illustrates a hidden node. Both stations (STA) are within range of the access point (AP) or wireless gateway, but out-of-range of each other, so they cannot “hear” each other, that is they do not know if the channel is currently being used. Therefore, they are considered hidden from each other.

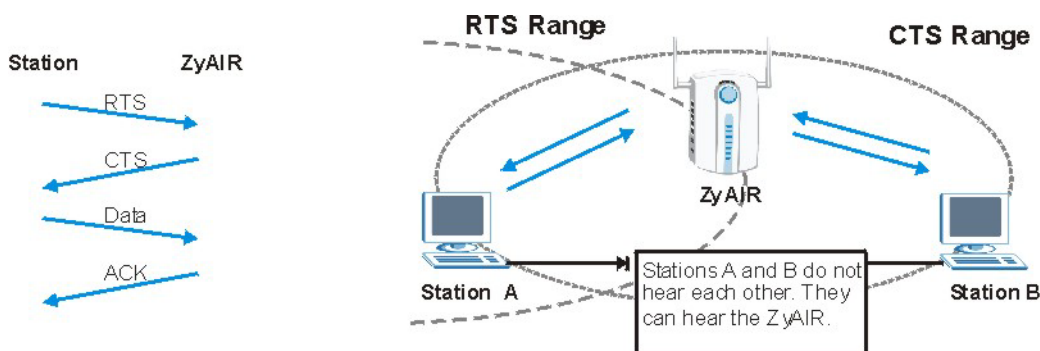

Figure 21-4 RTS/CTS

When station A sends data to the ZyAIR, it might not know that station B is already using the channel. If these two stations send data at the same time, collisions may occur when both sets of data arrive at the AP at the same time, resulting in a loss of messages for both stations.

RTS/CTS is designed to prevent collisions due to hidden nodes. An **RTS/CTS** defines the biggest size data frame you can send before an RTS (Request To Send)/CTS (Clear to Send) handshake is invoked.

When a data frame exceeds the **RTS/CTS** value you set (between 0 to 2432 bytes), the station that wants to transmit this frame must first send an RTS (Request To Send) message to the AP for permission to send it. The AP then responds with a CTS (Clear to Send) message to all other stations within its range to notify them to defer their transmission. It also reserves and confirms with the requesting station the time frame for the requested transmission.

Stations can send frames smaller than the specified **RTS/CTS** directly to the AP without the RTS (Request To Send)/CTS (Clear to Send) handshake.

You should only configure **RTS/CTS** if the possibility of hidden nodes exists on your network and the “cost” of resending large frames is more than the extra network overhead involved in the RTS (Request To Send)/CTS (Clear to Send) handshake.

If the **RTS/CTS** value is greater than the **Fragmentation Threshold** value (see next), then the RTS (Request To Send)/CTS (Clear to Send) handshake will never occur as data frames will be fragmented before they reach **RTS/CTS** size.



Enabling the RTS Threshold causes redundant network overhead that could negatively affect the throughput performance instead of providing a remedy.

21.2.7 Fragmentation Threshold

A **Fragmentation Threshold** is the maximum data fragment size (between 256 and 2432 bytes) that can be sent in the wireless network before the ZyAIR will fragment the packet into smaller data frames.

A large **Fragmentation Threshold** is recommended for networks not prone to interference while you should set a smaller threshold for busy networks or networks that are prone to interference.

If the **Fragmentation Threshold** value is smaller than the **RTS/CTS** value (see previously) you set then the RTS (Request To Send)/CTS (Clear to Send) handshake will never occur as data frames will be fragmented before they reach **RTS/CTS** size.

21.3 Wireless LAN Setup



If you are configuring the ZyAIR from a computer connected to the wireless LAN and you change the ZyAIR's ESSID or WEP settings, you will lose your wireless connection when you press Apply to confirm. You must then change the wireless settings of your computer to match the ZyAIR's new settings.

Click **ADVANCED SETUP** and then **WIRELESS** to open the **Wireless** screen.

WIRELESS

GeneralSetting:

ESSID:

Channel:

Security: Disable

WPA

Group Key Rekeying: per seconds

Use WPA with Pre-shared Key

Pre-shared Key: (8-63 characters)

Use WPA with RADIUS Server

Server IP/Domain:

Authentication Port:

Shared Secret Key:

WEP

Encryption: 64 bit 128 bit

Mode:

WEP Key:

1.

2.

3.

4.

Note: You have to restart the system to apply the WEP settings

Beacon Interval: (msec, range:1~1000, default:200)

RTS Threshold: (range:256~2432, default:2432)

Fragmentation Threshold: (range:800~2432, default:2432, even number only)

Preamble Type: Dynamic Preamble Short Preamble Long Preamble

Authentication Method: Open System Shared Key Both

Figure 21-5 WIRELESS

The following table describes the general wireless LAN fields in this screen.

Table 21-4 WIRELESS

LABEL	DESCRIPTION
ESSID	<p>(Extended Service Set IDentity) The ESSID identifies the Service Set with which a wireless station is associated. Wireless stations associating to the access point (AP) must have the same ESSID. Enter a descriptive name (up to 32 printable 7-bit ASCII characters) for the wireless LAN.</p> <p>If you are configuring the ZyAIR from a computer connected to the wireless LAN and you change the ZyAIR's ESSID or WEP settings, you will lose your wireless connection when you click Apply. You must then change the wireless settings of your computer to match the ZyAIR's new settings.</p>
Channel	Select a channel from the drop-down list box depending on your particular region.
Security	<p>Select Disable to allow wireless devices to communicate with the ZyAIR without any data encryption.</p> <p>Select WPA (Wi-Fi Protected Access) to have the ZyAIR perform user authentication and data encryption. WPA's data encryption is stronger than WEP.</p> <p>Select WEP (Wired Equivalent Privacy) to have the ZyAIR encrypt data frames before transmitting them over the wireless network. Select the check box to enable WEP data encryption. Then configure the WEP keys.</p>
WPA	
Group Key Rekeying	The Group Key Rekeying field sets how often the AP (if using WPA-PSK key management) or RADIUS server (if using WPA key management) sends a new group key out to all clients. The re-keying process is the WPA equivalent of automatically changing the WEP key for an AP and all stations in a WLAN on a periodic basis. Setting of the WPA Group Key Update Timer is also supported in WPA-PSK mode. The default is 8,600 seconds.
Use WPA with Pre-shared Key	Select this radio button to use a pre-shared key for WPA. Type a pre-shared key from 8 to 63 case-sensitive ASCII characters (including spaces and symbols).
Use WPA with RADIUS Server	Select this radio button to use a RADIUS server to authenticate the wireless clients.
Server IP/Domain	Enter the external authentication server's IP address (in dotted decimal notation) or domain name.
Authentication Port	You need not change this value unless your network administrator instructs you to do so with additional information.
Shared Secret Key	<p>Enter a password (up to 31 alphanumeric characters) as the key to be shared between the external authentication server and the ZyAIR.</p> <p>The key is not sent over the network. This key must be the same on the external authentication server and the ZyAIR.</p>
WEP	
Encryption	Select 64-bit or 128-bit for the WEP key length.
Mode	<p>Select the type of input mode from the drop-down list box. Choices are HEX and ASCII.</p> <p>Select ASCII to enter the WEP keys as ASCII characters.</p> <p>Select HEX to enter the WEP keys as hexadecimal characters.</p>

Table 21-4 WIRELESS

LABEL	DESCRIPTION
WEP Key 1 ... 4	<p>Enter the WEP keys in the fields provided and select a key as the default key to use.</p> <p>If you select 64 bit in the WEP Encryption field.</p> <ul style="list-style-type: none"> ♦ Enter either 10 hexadecimal digits in the range of "A-F", "a-f" and "0-9" (for example 11AA22BB33) for HEX key type <p>or</p> <ul style="list-style-type: none"> ♦ Enter 5 printable ASCII characters (case sensitive) ranging from "a-z", "A-Z" and "0-9" (for example MyKey) for ASCII key type. <p>If you select 128 bit in the WEP Encryption field,</p> <ul style="list-style-type: none"> ♦ Enter either 26 hexadecimal digits in the range of "A-F", "a-f" and "0-9" (for example, 00112233445566778899AABBCC) for HEX key type <p>or</p> <ul style="list-style-type: none"> ♦ Enter 13 printable ASCII characters (case sensitive) ranging from "a-z", "A-Z" and "0-9" (for example, MyKey12345678) for ASCII key type. <hr/> <p style="text-align: center;"> The values for the WEP keys must be set up exactly the same on all wireless devices in the same wireless LAN. ASCII WEP keys are case sensitive.</p> <hr/>
Beacon Interval	Set the number of milliseconds that should pass between sending out a beacon. Enter a time period between 1 and 1000. The default is 100 .
RTS Threshold	Enter a value between 0 and 2442 to enable an RTS/CTS handshake to avoid retransmitting due to hidden nodes. The default is 2432 .
Fragmentation Threshold	Enter a value between 256 and 2446 to enable a fragmentation threshold. This sets the maximum size of data fragments that can be sent. The default is 2432 . Use a low setting if there is a great deal of radio interference.
Preamble Type	<p>Preamble is used to signal that data is coming to the receiver.</p> <p>Short preamble increases performance as less time sending preamble means more time for sending data. All IEEE 802.11b compliant wireless adapters support long preamble, but not all support short preamble.</p> <p>Select Long Preamble if you are unsure what preamble mode the wireless adapters support, and to provide more reliable communications in busy wireless networks. Select Short Preamble if you are sure the wireless adapters support it, and to provide more efficient communications.</p>

Table 21-4 WIRELESS

LABEL	DESCRIPTION
Authentication Method	<p>Select Open System to allow any device to authenticate and then attempt to communicate with the ZyAIR. Using open authentication, any wireless device can authenticate with the ZyAIR, but the device can only communicate if its WEP keys match the ZyAIR. Devices not using WEP do not attempt to authenticate with a ZyAIR that is using WEP. Open authentication does not rely on a RADIUS server on your network.</p> <p>Select Shared Key to have the ZyAIR use shared key authentication. The ZyAIR sends an unencrypted challenge text string to any device attempting to communicate with the ZyAIR. The device-requesting authentication encrypts the challenge text and sends it back to the ZyAIR. If the challenge text is encrypted correctly, the ZyAIR allows the requesting device to authenticate. However, both the unencrypted challenge and the encrypted challenge can be monitored; thus leaving the ZyAIR open to attack from an intruder who calculates the WEP key by comparing the unencrypted and encrypted text strings. Because of this weakness, shared key authentication can be less secure than open authentication. Like open authentication, shared key authentication does not rely on a RADIUS server on your network.</p> <p>Select Both to allow subscribers to communicate with or without data encryption.</p>
Default	Click this button to load the factory default wireless LAN settings.
Apply	Click Apply to save the settings.

Part V:

System Status, System Tools and Troubleshooting

This part covers the **SYSTEM STATUS** and **SYSTEM TOOLS** screens and troubleshooting.

Please note that **SYSTEM ACCOUNT** is discussed in Part 1.

Chapter 22

System Status

*This chapter describes the screens under **SYSTEM STATUS**.*

22.1 About System Status

The screens in **SYSTEM STATUS** show the current state of the ZyAIR.

22.2 View System Information

Click **SYSTEM STATUS** and **SYSTEM** to display the screen as shown next.

SYSTEM

Detailed system information refresh ↻		
Service	Internet Connection	OK
	Wireless Service	OK
System	Host Name	
	Domain Name	
	Firmware Version	V1.00(ZB.4)b2
	Wireless Firmware Version	1.2.8
	BootROM Version	1.02
	WAN MAC Address	00:A0:C5:B7:BC:F7
	LAN MAC Address	00:A0:C5:B7:BC:F6
	System Time	2002/1/1 02:11:24
LAN IP	System Up Time	00D:02H:11M:24S
	IP Address	192.168.1.1
	Subnet Mask	255.255.255.0
	WAN Port Mode	Static IP (Connect)
WAN IP	IP Address	192.168.10.46
	Subnet Mask	255.255.254.0
	Default IP Gateway	192.168.10.11
	Primary DNS Server	192.168.11.4
DNS	Secondary DNS Server	168.95.1.1
	DHCP Status	Server
DHCP	Start IP Address	192.168.1.2
	End IP Address	192.168.1.254
	Lease Time	300
	ESSID	PQA-3254-g1
Wireless	Channel	1
	Encryption	WPA
	E-mail Redirection	
Network Traffic	WAN Traffic	Tx Data: 132132 Rx Data: 0 Tx Error: 0 Rx Error: 0
	LAN Traffic	Tx Data: 421896 Rx Data: 216620 Tx Error: 0 Rx Error: 0
	Wireless Traffic	Tx Data: 484 Rx Data: 0 Tx Error: 667 Rx Error: 0
Location Information	Location Name	
	Address	
	City	
	State / Province	
	ZIP / Postal Code	
	Country	
	Contact Name	
	Contact Telephone	
	Contact FAX	
Contact Email		
SSL Certificate	Country	00
	State	Local State
	Local City	Local City
	Organization	Local Group
	Organization Unit	Local Host
	Common Name	1.1.1.1
	Email Address	mail@1.1.1.1

Figure 22-1 SYSTEM

The following table describes the labels in this screen.

Table 22-1 System

LABEL	DESCRIPTION
Service	
Internet Connection	This field displays the status of the ZyAIR's connection to the Internet.
Wireless Service	This field displays the status of the ZyAIR's wireless LAN.
System	
Host Name	This field displays the description name of the ZyAIR for identification purposes.
Domain Name	This field displays the domain name of the ZyAIR.
Firmware Version	This field displays the version of the firmware on the ZyAIR.
Wireless Firmware Version	This field displays the version of the wireless features on the ZyAIR.
Bootrom Version	This field displays the version of the bootbase in the ZyAIR.
WAN MAC Address	This field displays the MAC address of the ZyAIR on the WAN.
LAN MAC Address	This field displays the MAC address of the ZyAIR on the LAN.
System Time	This field displays the ZyAIR's current time.
System Up Time	This field displays the how long the ZyAIR has been operating since it was last started.
LAN IP	
IP Address	This field displays the IP address of the LAN port on the ZyAIR.
Subnet Mask	This field displays the subnet mask of the LAN port on the ZyAIR.
WAN IP	
WAN Port Mode	This field displays the DHCP mode of the WAN port. It displays DHCP Client , Static IP Setting , PPPoE or PPTP .
IP Address	This field displays the IP address of the WAN port on the ZyAIR.
Subnet Mask	This field displays the subnet mask of the WAN port on the ZyAIR.
Default IP Gateway	This field displays the IP address of the default gateway of the WAN port on the ZyAIR.
DNS	
Primary DNS Server	This field displays the IP address of the primary DNS server.
Secondary DNS Server	This field displays the IP address of the secondary DNS server.
DHCP	
DHCP Status	This field displays the DHCP mode on the LAN.
Start IP Address	This field displays the first of the continuous addresses in the IP address pool.
End IP Address	This field displays the last of the continuous addresses in the IP address pool.
Lease Time	This field displays the time period (in minutes between 1 and 71582788) during which a DHCP client is allowed to use an assigned IP address. When the lease time expires, the DHCP client is given a new, unused IP address.
Wireless	

Table 22-1 System

LABEL	DESCRIPTION
ESSID	This field displays the ZyAIR's Extended Service Set IDentity.
Channel	This field displays the channel that the ZyAIR is using.
Encryption	This field displays the type of data encryption that the ZyAIR is using. WEP displays if the ZyAIR is using WEP data encryption. WPA displays if ZyAIR is using WPA data encryption. Disable displays if the ZyAIR is not using data encryption.
E-mail Redirection	This field displays the IP address or the domain name of the SMTP server.
Network Traffic	
WAN Traffic	This field displays traffic statistics for the ZyAIR's WAN connection.
LAN Traffic	This field displays traffic statistics for the ZyAIR's LAN connection.
Wireless Traffic	This field displays traffic statistics for the ZyAIR's wireless LAN connection.
Location Information	
Location Name	This field displays the device's geographical location.
Address	This field displays the street address of the device's location.
City	This field displays the city of the device's location.
State / Province	This field displays the state or province of the device's location.
ZIP/ Postal Code	This field displays the zip code or postal code for the device's location.
Country	This field displays the country of the device's location.
Contact Name	This field displays the name of the person responsible for this device.
Contact Telephone	This field displays the telephone number of the person responsible for this device.
Contact FAX	This field displays the fax number of the person responsible for this device.
Contact Email	This field displays the e-mail address of the person responsible for this device.
SSL Certificate	
Country	This field displays the two-letter abbreviation of your country.
State	This field displays the name of the state or province where your organization is located.
Local City	This field displays the name of the city your organization is located.
Organization	This field displays the name of your organization.
Origination Unit	This field displays additional information about your organization.
Common Name	This field displays the fully qualified domain name of your web server.
Email Address	This field displays your e-mail address.

22.3 Account List

Refer to the *Accounting* chapter for an example and explanation of the **ACCOUNT LIST** screen.

22.4 Account Log

The **ACCOUNT LOG** screen displays information on the ZyAIR's subscriber account logs.

Click **SYSTEM STATUS** and **ACCOUNT LOG** to display the screen as shown. Click a column heading to sort the entries if applicable.

SN	Username	Time Created	Login Time	Usage Time	Charge	Payment Info	Status
000001	mgupj822	2004/1/29 10:04:12		0:30:00	1.00	Cash	Expired
000002	9w269m22	2004/1/29 10:07:12		0:30:00	1.00	Cash	Expired
000003	bwh2y822	2004/1/29 10:07:22		1:00:00	2.00	Cash	Expired
000004	3dfgk728	2004/1/29 10:07:20		2:00:00	3.00	Cash	Expired

Figure 22-2 ACCOUNT LOG

The following table describes the labels in this screen.

Table 22-2 ACCOUNT LOG

LABEL	DESCRIPTION
Clear Log	Click Clear Log to remove all of the log entries from the ZyAIR's memory and this screen.
Refresh	Click Refresh to update this screen.
SN	This field displays the index number of an entry. The maximum number of user account entries is 512.
Username	This field displays the account user name. Click the heading to sort the entries in ascending or descending order based on this column.
Time Created	This field displays when the account was created (in yyyy/mm/dd HH/mm/ss format). Click the heading to sort the entries in ascending or descending order based on this column.
Login Time	This field displays when the subscriber logged in to use the account (in yyyy/mm/dd HH/mm/ss format). Click the heading to sort the entries in ascending or descending order based on this column.
Usage Time	This field displays the amount of time the subscriber has purchased. Click the heading to sort the entries in ascending or descending order based on this column.
Charge	This field displays the total cost of the subscriber's account.
Payment Info	This field displays the subscriber's method of payment cash or credit.
Status	This field displays IN-Used when the account is currently in use. Otherwise it displays UN-Used . This field displays Finished when a subscriber uses up the time allocated to an account. This field displays Expired when a subscriber's account has reached expiration. This field displays Replenished and the serial number of the subscriber's account when a subscriber has purchased additional time units for the account.
Page	Select a page number from the drop-down list box to display the selected page.
First	Click First to go to the first page.

Table 22-2 ACCOUNT LOG

LABEL	DESCRIPTION
Previous	Click Previous to return to the previous page.
Next	Click Next to go to the next page.
End	Click End to go to the last page.

22.5 Current Users

The **CURRENT USER** screen displays a list of subscribers currently logged on to the ZyAIR for Internet access.

Click **SYSTEM STATUS** and **CURRENT USER** to display the screen as shown. Click a column heading to sort the entries if applicable.

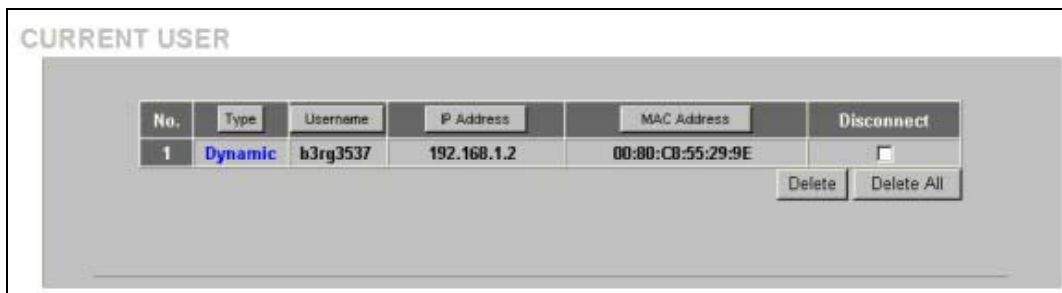

Figure 22-3 CURRENT USER

The following table describes the labels in this screen.

Table 22-3 CURRENT USER

LABEL	DESCRIPTION
No.	This field displays the index number of the entry.
Type	This field displays the type of account that the user has.
Username	This field is displayed only if any subscribers are using the system. This field displays the username currently used by the account.
IP Address	This field displays the IP address of a subscriber's computer.
MAC Address	This field displays the MAC address of the computer that is logged in using the account.
Disconnect	This field is displayed only if any subscribers are using the system. Select this(ese) checkbox(es) and click Delete to terminate the selected subscriber connection.
Delete All	Click this button to terminate all subscriber connections.

22.6 DHCP Clients

The DHCP client table shows current DHCP client information of all network clients using the DHCP server on the ZyAIR.

Click **SYSTEM STATUS** and **DHCP** to display the screen as shown.

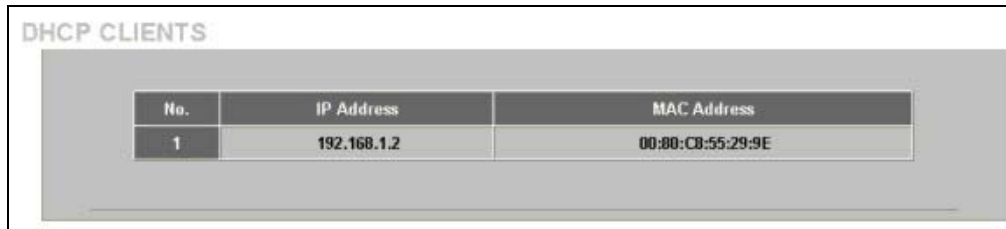

The screenshot shows a window titled "DHCP CLIENTS" containing a table with the following data:

No.	IP Address	MAC Address
1	192.168.1.2	00:00:C8:55:29:9E

Figure 22-4 DHCP CLIENTS

The following table describes the labels in this screen.

Table 22-4 DHCP CLIENTS

LABEL	DESCRIPTION
No.	This field displays the index number of the entry.
IP Address	This field displays the IP address of the client computer.
MAC Address	This field displays the MAC address of the client computer. The MAC (Media Access Control) or Ethernet address on a LAN (Local Area Network) is unique to your computer (six pairs of hexadecimal characters). A network interface card such as an Ethernet adapter has a hardwired address that is assigned at the factory. This address follows an industry standard that ensures no other adapter has a similar address.
IP Address	This field displays the IP address assigned to the client computer.

22.7 Session List

To display a list of incoming and outgoing packet information, click **SYSTEM STATUS** and **Session List**.

No.	TCP/UDP	Client IP	Client Port	Port Fake	Remote IP	Remote Port	Idle
1	TCP	192.168.1.2	1298	50070	207.46.245.92	80	51
2	UDP	192.168.1.2	1299	50071	168.95.1.1	53	51
3	UDP	192.168.1.2	1301	50073	168.95.1.1	53	51
4	TCP	192.168.1.2	1302	50074	207.46.196.100	80	25
5	UDP	192.168.1.2	1303	50075	168.95.1.1	53	51
6	TCP	192.168.1.2	1304	50076	65.54.192.249	80	51
7	UDP	192.168.1.2	1308	50079	168.95.1.1	53	25
8	UDP	192.168.1.2	1309	50080	168.95.1.1	53	25
9	UDP	192.168.1.2	1310	50081	168.95.1.1	53	25
10	UDP	192.168.1.2	1312	50082	168.95.1.1	53	0
11	UDP	192.168.1.2	1314	50084	168.95.1.1	53	0
12	UDP	192.168.1.2	1316	50086	168.95.1.1	53	0
13	TCP	192.168.1.2	1317	50087	211.196.154.190	80	0
14	UDP	192.168.1.2	1321	50088	168.95.1.1	53	0
15	TCP	192.168.1.2	1322	50089	211.196.154.190	80	0
16	TCP	192.168.1.2	1323	50090	211.196.154.190	80	0
17	TCP	192.168.1.2	1324	50091	211.196.154.190	80	0
18	TCP	192.168.1.2	1325	50092	211.196.154.214	80	0
19	TCP	192.168.1.2	1326	50093	211.196.154.214	80	0
20	UDP	192.168.1.2	1327	50094	168.95.1.1	53	0

Figure 22-5 SESSION LIST

The following table describes the fields in this screen.

Table 22-5 SESSION LIST

LABEL	DESCRIPTION
Page	Select a page number from the drop-down list box to display the selected page.
First	Click First to go to the first page.
Previous	Click Previous to return to the previous page.
Next	Click Next to go to the next page.
End	Click End to go to the last page.
No	This field displays the index number of an entry.
TCP/UDP	This field displays the type of traffic (TCP or UDP).
IP Client	This field displays the IP address of the client computer.
Port Client	This field displays the port number through which the client computer transmits the traffic.
Port Fake	This field displays the NAT port to and from which the ZyAIR maps the session's traffic.
Remote IP	This field displays the IP address of a remote device the client computer accesses.
Remote Port	This field displays the port number of a remote device the client computer accesses.
Idle	This field displays how many seconds are left before the session times out if there is no more traffic. The ZyAIR automatically times out idle TCP sessions after 5 minutes (300 seconds). The ZyAIR automatically times out idle UDP sessions after 1 minute (60 seconds).

22.8 LAN Devices

The **SYSTEM STATUS LAN DEVICES** screen displays the status of LAN devices configured in the **ADVANCED LAN DEVICES** screen (refer to the *LAN Devices* chapter).

Click **SYSTEM STATUS** and **LAN DEVICES** to display the screen as shown next. This screen automatically updates every minute.

NO.	Device Name	Status	Virtual Port (60001-60050)	Device IP Address	Device Server Port	Device MAC Address	Application	Interface
1	Server	OK	60001	192.168.1.2	23	00:80:C8:55:29:9E	TCP	Wired

Figure 22-6 LAN DEVICES

The following table describes the labels in this screen.

Table 22-6 LAN DEVICES

LABEL	DESCRIPTION
No	This field displays the index number.
Device Name	This field displays the name of the LAN device. Click the device name to access the LAN device if the Status field is OK . For more information on accessing a LAN device, refer to <i>Section 22.8.1</i> .
Status	This field displays the current status of the LAN device. It displays OK when the LAN device is turned on and working properly. Otherwise it displays Fail .
Virtual Port (60001-60050)	This field displays the virtual port number.
Device IP Address	This field displays the IP address of the LAN device.
Device Server Port	This field displays the server port number of the LAN device.
Device MAC Address	This field displays the MAC address of the LAN device.
Application	This field displays the type of application packet that is forwarded to the LAN device.
Interface	This field displays to which interface on the ZyAIR the LAN device is connected.

22.8.1 Accessing a LAN Device

Before you can access a LAN device behind the ZyAIR, the following requirements must be met.

- The LAN device has a web-based management interface and it is enabled.
- You have set up the virtual port mapping to the LAN device server port in the **LAN Device Management** screen.
- The LAN device status is **OK** in the **LAN Device Status** screen.

There are two methods to access the LAN device: directly or through the web configurator.

To access the LAN device through the web configurator, open the **LAN Device Status** screen and click the device name. A new Internet browser should display showing the login screen of the LAN device management interface.

To directly access the LAN device, enter the WAN IP address of your ZyAIR and the virtual port number of the LAN device separated by a colon. For example, enter “http:// 192.168.1.1:60001” where 192.168.1.1 is the WAN IP address of the ZyAIR. The login screen of the LAN device management interface should display.

Chapter 23

Configuration, Firmware and Accounting Log Maintenance

This chapter shows you how to upgrade the firmware and configuration file and back up configuration files and accounting logs.

23.1 Filename Conventions

The configuration file contains the factory default settings in the menus such as password, DHCP Setup, TCP/IP Setup, etc. Once you have customized the settings of the ZyAIR, they can be saved back to your computer under a filename of your choosing.

It is recommended to use the “.bin” file extension for the firmware file and “.rom” for the configuration file for management purposes.

Visit www.zyxel.com to download the latest version of firmware for your ZyAIR.

23.2 Configuration File Maintenance

You can use the web configurator to perform configuration file backup and restore. Backing up the configuration allows you to back up (save) the device's current configuration to a file. Once your device is configured and functioning properly, it is highly recommended that you back up your configuration file before making configuration changes. The backup configuration file will be useful in case you need to return to your previous settings.



WARNING!
**DO NOT INTERRUPT THE FILE TRANSFER PROCESS AS THIS
MAY PERMANENTLY DAMAGE YOUR DEVICE.**

23.2.1 Backup Configuration Using HTTP

Use the following procedure to use HTTP to back up the device's current configuration to a file on your computer.

1. Click **SYSTEM TOOLS** and **CONFIGURATION**. A screen displays as shown next.

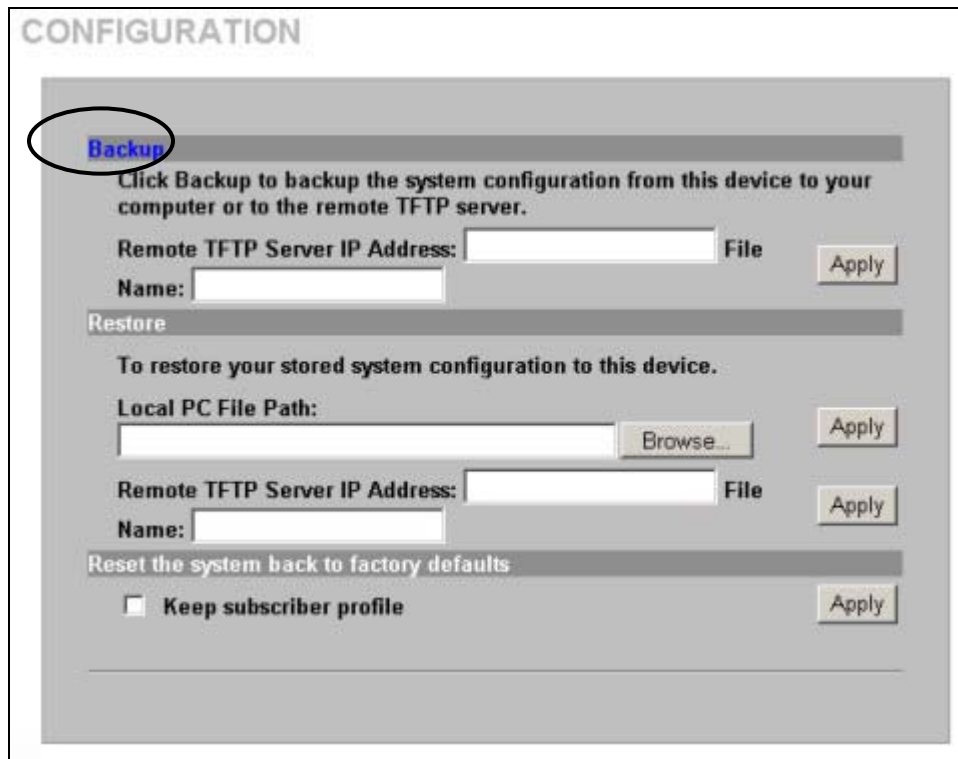

Figure 23-1 CONFIGURATION: Backup Using HTTP

2. Click **Backup**. A **File Download** window displays as shown next.

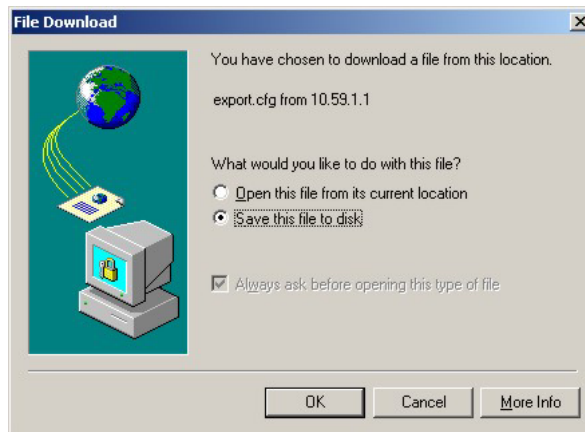

Figure 23-2 Configuration Backup: File Download

3. Select **Save this file to disk** and click **OK**. A **Save As** window displays.

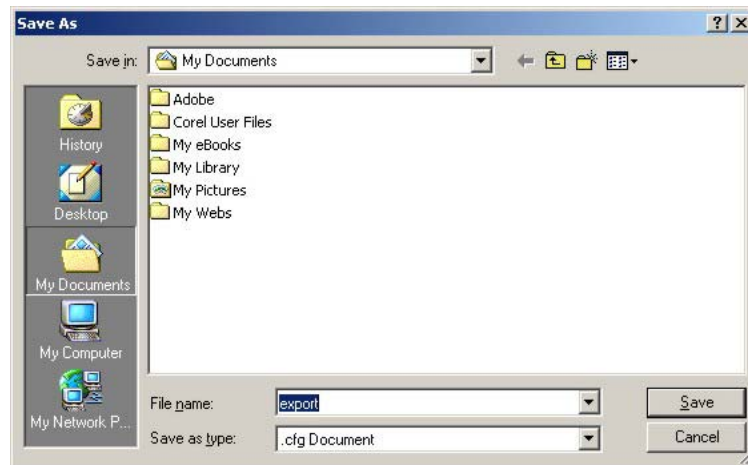

Figure 23-3 Configuration Backup: Save As

4. Specify the file name and/or location and click **Save** to start the backup process.

23.2.2 Backup Configuration Using TFTP

Use the following procedure to use TFTP to back up the device's current configuration to a file on a TFTP server.

1. Click **SYSTEM TOOLS** and **CONFIGURATION**. A screen displays as shown next.

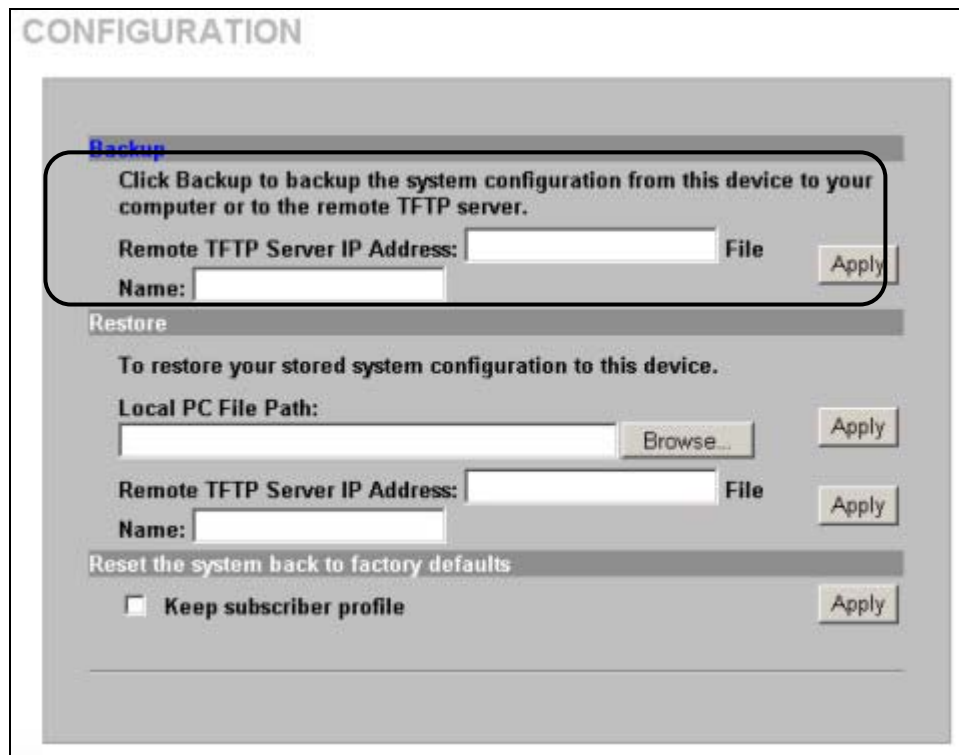

Figure 23-4 CONFIGURATION: Backup Using TFTP

2. Enter the IP address of the TFTP server in dotted decimal notation in the **Remote TFTP Server IP Address** field.

3. Specify a file name for the configuration backup in the **File Name** field.
4. Click **Apply**. When the file transfer process is complete, a screen displays as follows.

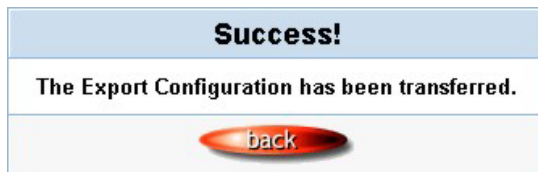

Figure 23-5 Configuration Backup: Using TFTP Successful

23.2.3 Restore Configuration Using HTTP

This section shows you how to upload a new or previously saved configuration file from your computer to your ZyAIR.



This function erases the current configuration before restoring a previous back up configuration; please do not attempt to restore unless you have a backup configuration file stored on disk.

1. Click **SYSTEM TOOLS** and **CONFIGURATION**. A screen displays as shown next.

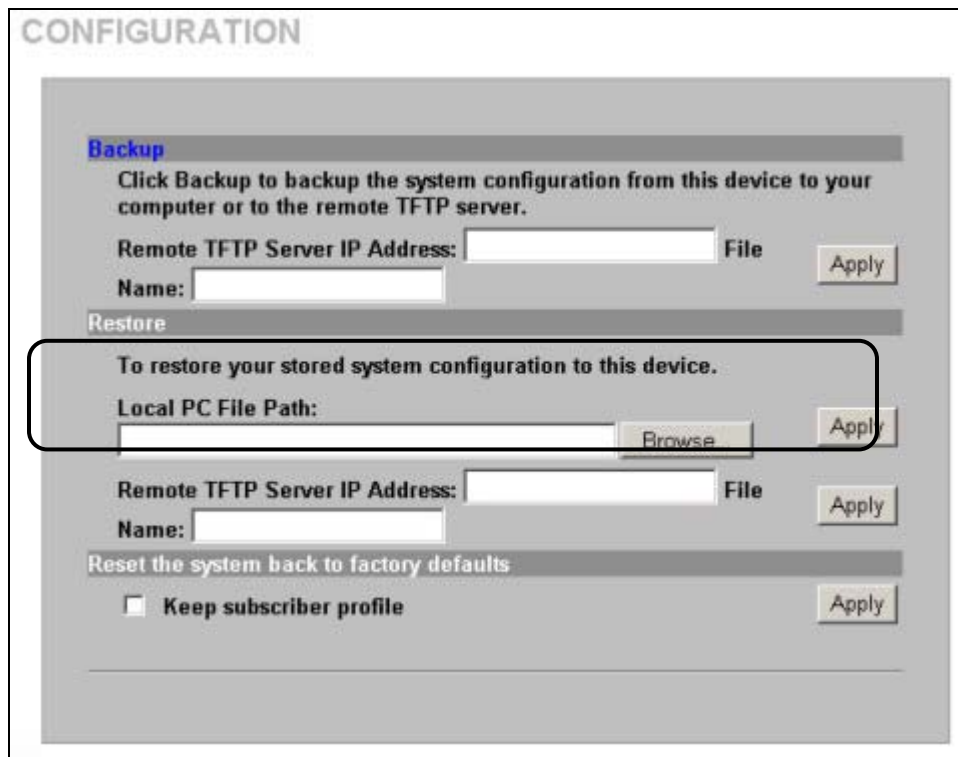

Figure 23-6 CONFIGURATION: Restore Using HTTP

2. Specify the location and filename of a configuration file in the **Local PC File Path** field or click **Browse**.
3. Click **Apply** to start the configuration restore process. The ZyAIR automatically restarts after the restoration process is complete.

23.2.4 Restore Configuration Using TFTP

This section shows you how to upload a new or previously saved configuration file from a TFTP server to your ZyAIR.



This function erases the current configuration before restoring a previous back up configuration; please do not attempt to restore unless you have a backup configuration file stored on disk.

1. Click **System Tools** and **Configuration**. A screen displays as shown next.

The screenshot shows the 'CONFIGURATION' web interface. The 'Restore' section is highlighted with a black box. It contains the following fields and buttons:

- Remote TFTP Server IP Address:** A text input field followed by a 'File' button and an 'Apply' button.
- Name:** A text input field.
- Local PC File Path:** A text input field followed by a 'Browse...' button and an 'Apply' button.
- Remote TFTP Server IP Address:** A text input field followed by a 'File' button and an 'Apply' button.
- Name:** A text input field.
- Keep subscriber profile:** A checkbox followed by an 'Apply' button.

Figure 23-7 CONFIGURATION: Restore Using TFTP

2. Enter the IP address of the TFTP server in dotted decimal notation in the **Remote TFTP Server IP Address** field.
3. Specify the file name of the configuration file in the **File Name** field.
4. Click **Apply** to start the configuration restore process. The ZyAIR automatically restarts after the restoration process is complete.

23.3 Firmware Upgrade

There are two ways to upgrade firmware to the ZyAIR: manually or scheduled.

To manually upgrade the firmware, you have to download the latest firmware first from www.zyxel.com and then upload it to the ZyAIR. You can upload it to the ZyAIR using the Web Configurator or using a TFTP server.

With scheduled firmware upgraded, you need to set up a TFTP server where the ZyAIR can automatically download the latest firmware at the specified time.



If you are upgrading to firmware version v1.00(ZB.3)c0 or higher from a lower version, you might upgrade the boot code to v1.03 as well. In this case, you must upgrade the firmware **BEFORE** you upgrade the boot code.

23.3.1 Manual Firmware Upgrade Using the Web Configurator

Follow the steps below to upload the firmware using the web configurator.

5. Click **SYSTEM TOOLS, FIRMWARE** and then **Manual Firmware Upgrade** to display the screen as shown.

FIRMWARE

Manual Firmware Upgrade	Scheduled Firmware Upgrade
Firmware	
Local PC File Path	<input type="text"/> Browse... Apply
Remote TFTP Server IP Address:	<input type="text"/>
File Name:	<input type="text"/> Apply
Boot Code	
Local PC File Path	<input type="text"/> Browse... Apply

Figure 23-8 Manual Firmware Upgrade Using the Web Configurator

6. Specify the name of the firmware file in the **Local PC File Path** field or click **Browse** to locate the file and click **Apply** to start the file transfer process. The firmware must be a binary file and should have a .bin extension.
7. When the file transfer is completed successfully, a restart message displays and the ZyAIR automatically restarts.



WARNING!
Do not interrupt the file upload process as this may **PERMANENTLY** damage the device.

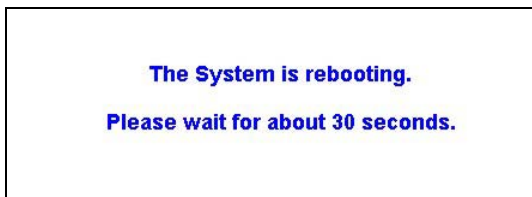

Figure 23-9 System Restart

- After the ZyAIR finishes restarting, access the web configurator again. Check the firmware version number in the **System** screen.



When the ZyAIR restarts, all connections terminate. Subscribers need to log in again.

23.3.2 Manual Firmware Upgrade via TFTP Server

Use the following procedure to use TFTP to upload the firmware from a TFTP server to the ZyAIR.

- Download the latest firmware from www.zyxel.com and store it in a TFTP server. Unzip the file if it is zipped.
- Run a TFTP server program and specify the location of the firmware file and the communication mode. Refer to the documentation that comes with your TFTP server program for instructions.
- Access the web configurator. Refer to the section on accessing the web configurator for instructions.
- Click **SYSTEM TOOLS**, **FIRMWARE** and then **Manual Firmware Upgrade** to display the screen as shown.

FIRMWARE

Figure 23-10 Manual Firmware Upgrade via TFTP Server

- Specify the IP address of the TFTP server in the **Remote TFTP Server IP Address** field.
- Specify the name of the firmware file in the **File Name** field.
- Click **Apply** to start the file transfer process.
- When the file transfer is completed successfully, the following message displays and the ZyAIR restarts automatically to complete the firmware upgrade process.
- After the ZyAIR finishes restarting, access the web configurator again. Check the firmware version number in the **System Status** screen.

23.3.3 Manual Boot Code Upgrade Using the Web Configurator

 You might upgrade the boot code to v1.03 only if you are upgrading to firmware version v1.00(ZB.3)c0 or higher from a lower version. In this case, you must upgrade the firmware **BEFORE** you upgrade the boot code.

Follow the steps below to upload the boot code using the web configurator.

1. Click **SYSTEM TOOLS**, **FIRMWARE** and then **Manual Firmware Upgrade** to display the screen as shown.

FIRMWARE

Figure 23-11 Manual Boot Code Upgrade Using the Web Configurator

2. Specify the name of the boot code file in the **Local PC File Path** field or click **Browse** to locate the file and click **Apply** to start the file transfer process. The boot code must be a binary file and should have a .rom extension.
3. When the file transfer is completed successfully, a restart message displays and the ZyAIR automatically restarts.

 **WARNING!**
Do not interrupt the file upload process as this may **PERMANENTLY** damage the device.

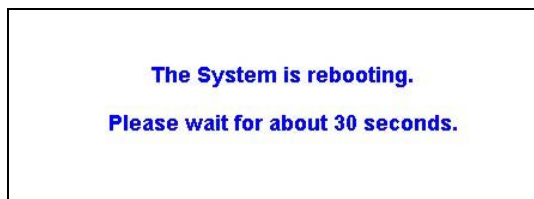

Figure 23-12 System Restart

4. After the ZyAIR finishes restarting, access the web configurator again. Check the Boot ROM version number in the **System** screen.



When the ZyAIR restarts, all connections terminate. Subscribers need to log in again.

23.3.4 Scheduled Firmware Upgrade

Click **SYSTEM TOOLS**, **FIRMWARE** and then **Scheduled Firmware Upgrade** to display the screen as shown.

Configure the screen to automatically download the latest firmware from a TFTP server.



Make sure that the TFTP server has the firmware and synchronization check file before you configure for scheduled firmware upgrades.

Make sure that you check new features or functionality enhancements in new firmware releases before you put the firmware on the TFTP server.



WARNING!
Do not interrupt the file upload process as this may PERMANENTLY damage the device.

FIRMWARE

Manual Firmware Upgrade **Scheduled Firmware Upgrade**

Disable
 Enable

TFTP Server IP:

File Synchronization: [View Sample](#)
[File](#)

Frequency
 Weekly Daily Hourly
 Sunday Hour Min.

Figure 23-13 Scheduled Firmware Upgrade



When the ZyAIR restarts, all connections terminate. Subscribers need to log in again.

Table 23-1 Scheduled Firmware Upgrade

LABEL	DESCRIPTION
Disable Enable	Select Disable or Enable to turn the scheduled firmware upgrade function on or off (disabled by default).
TFTP Server IP	Type the IP address of the TFTP server from which the ZyAIR can download new firmware files.
File Synchronization	A synchronization check file is a .txt file containing the latest firmware filename and version number on the TFTP server. Enter the name of the check file.
View Sample File	Click View Sample File to see an example synchronization check file (see <i>Figure 23-14</i>).
Frequency	Set how often (Weekly , Daily or Hourly) you want to have the ZyAIR check for new firmware and upgrade to new firmware if available (default Weekly). Then select the day (applies only when you select Weekly), the hour (applies when you select Daily or Hourly) and the minute that you want the ZyAIR to do the check and upload.
Apply	Click Apply to save the changes.

The following figure shows an example of a check file's content.

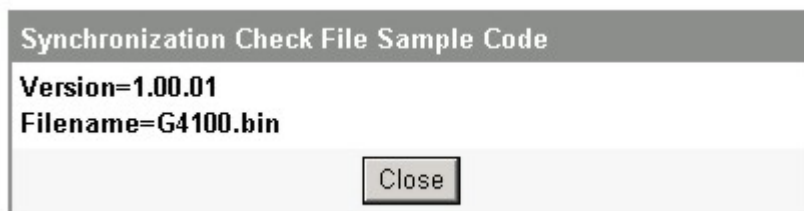

Figure 23-14 Synchronization Check File Example

Chapter 24

SSL (Secure Socket Layer) Security

This chapter shows you how to setup and enable Secure Socket Layer (SSL) security on the ZyAIR.

24.1 About SSL

SSL (Secure Socket Layer) security is a standard Internet protocol for secure communications that uses a combination of certificate-based authentication and public-key encryption. SSL protects data transfer between the web configurator on the ZyAIR and the web browser on a connected computer.

With SSL security activated, data (such as user name and password) transferred between the ZyAIR and the computer is protected when you access the ZyAIR using a web browser that supports SSL.

24.2 Activating SSL Security for Management Connections

Follow the steps below to activate the SSL security for management connections to the ZyAIR.

1. Click **ADVANCED** and then **SERVER**. Select the **SSL Security** check box under **Web Server**.

The screenshot shows the 'SERVER' configuration page. The 'Web Server' section is expanded, showing the following settings:

- Web Server Port: 80 (90, 401 - 1080)
- SSL Security (circled in red)
- Administrator Idle-Timeout: 5 Min(s) (1 - 1440)

The 'DHCP Server' section is also expanded, showing the following settings:

- DHCP Disable
- DHCP Relay
- DHCP Server (Default)
- DHCP Server IP Address: [Empty]
- IP Pool Starting Address: 192.168.1.2
- Pool Size: 253 (Max = 1024)
- Lease Time: 300 (Minutes)
- Primary DNS Server: 168.95.1.1
- Secondary DNS Server: [Empty]

The 'Email Server Redirect' section is also expanded, showing the following settings:

- IP Address or Domain Name: [Empty]
- SMTP Port: 25 (25, 2500 - 2599)

An 'Apply' button is located at the bottom of the page.

Figure 24-1 System Settings: Server Configuration: Enable SSL Security

2. Click **Apply** to save the changes and restart the ZyAIR when prompted. See section 24.3 for details on how to install the SSL security certificate in order to access the web configurator through a secure connection.

24.3 Viewing and Installing the SSL Security Certificate

After you enable and activate the SSL security on the ZyAIR, you can access the web configurator through a secure connection.

Follow the steps below to view and install the default SSL security certificate on your computer.

1. Access the ZyAIR. A **Security Alert** window displays. Click **OK** to continue and close the window.



Figure 24-2 Installing the SSL Security Certificate: First Security Alert

2. A second **Security Alert** window displays.

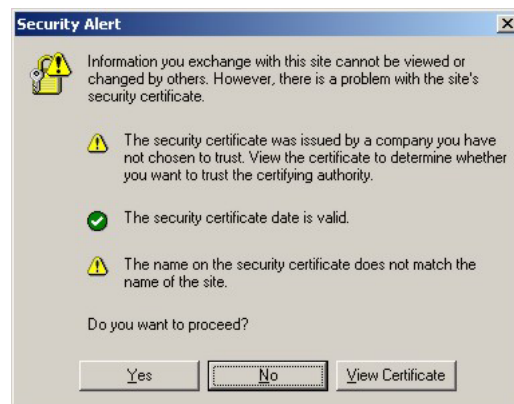

Figure 24-3 Installing the SSL Security Certificate: Second Security Alert

3. Click **View Certificate** to display the **Certificate** window as shown.



Figure 24-4 Installing the SSL Security Certificate: View Certificate

4. Click **Install Certificate** to install the certificate to your computer. A **Certificate Import Wizard** window displays. Click **Next**.



Figure 24-5 Installing the SSL Security Certificate: Certificate Import Wizard

5. Accept the default or specify the location to store the certificate. Click **Next**.

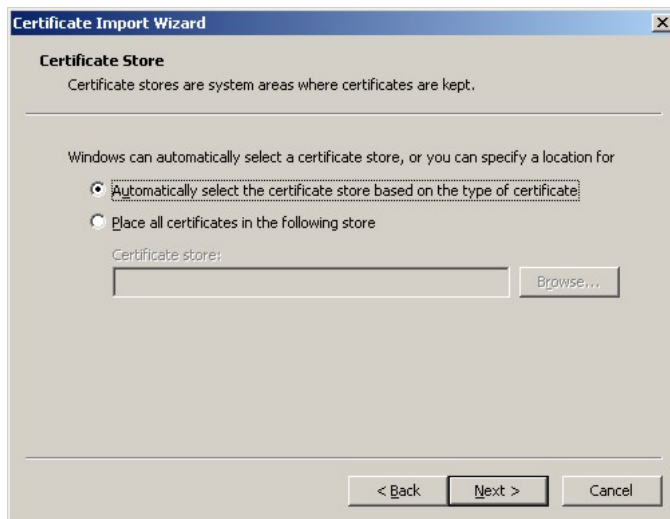

Figure 24-6 Certificate Import Wizard: Location

6. Click **Finish** to import the certificate.



Figure 24-7 Certificate Import Wizard: Finish

7. A **Root Certificate Store** window displays as shown. Click **Yes** to store the certificate to the computer.

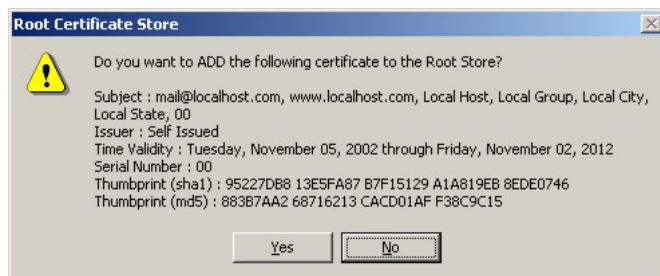

Figure 24-8 Root Certificate Store

8. When the certificate is saved successfully, a **Certificate Import Wizard** window displays. Click **OK**.



Figure 24-9 Certificate Import Wizard

9. A **Certificate** window displays the detail information.



Figure 24-10 Certificate: Details

10. Click **OK** in the **Certificate** window to return to the **Security Alert** window as shown. Notice that the first item in the list changed to inform you that the certificate is from a trusted host. Click **OK** to proceed to the login screen in secure mode.

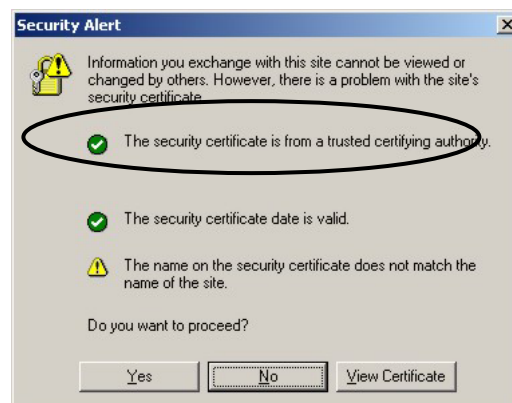
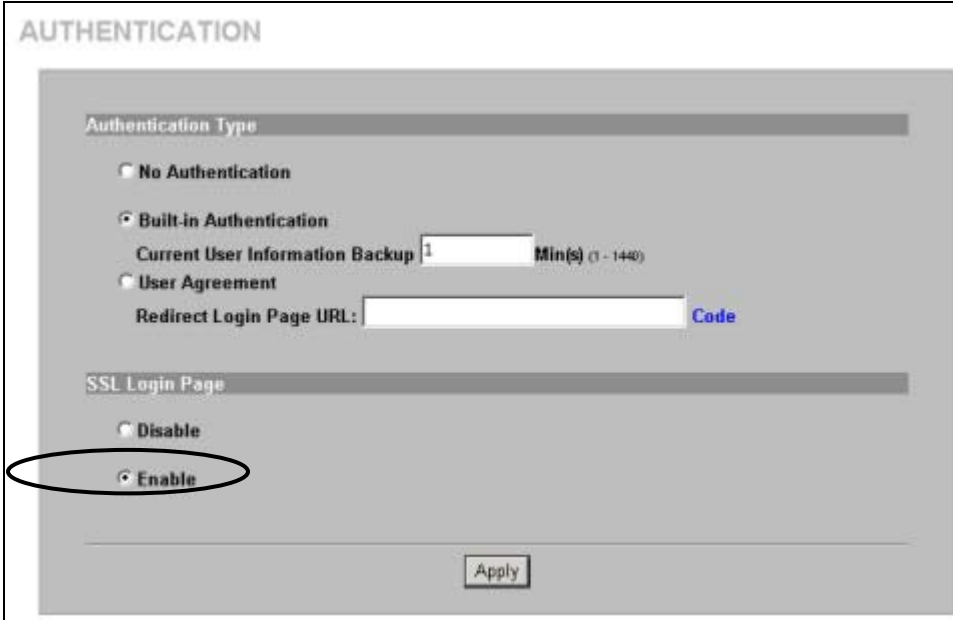

Figure 24-11 Security Alert: Trusted

24.4 Activating SSL Security for Subscriber Logins

Follow the steps below to activate the SSL security for subscriber login connections to the ZyAIR.

1. Click **ADVANCED**, **AUTHENTICATION** and select the **Enable** in the **SSL Login Page** field



The screenshot shows the 'AUTHENTICATION' configuration page. Under the 'Authentication Type' section, three radio buttons are visible: 'No Authentication', 'Built-in Authentication', and 'User Agreement'. The 'Built-in Authentication' option is selected. Below it, there is a 'Current User Information Backup' field with the value '1' and a 'Min(s) (1 - 1440)' label. A 'Redirect Login Page URL' field is also present with a 'Code' link. The 'SSL Login Page' section has two radio buttons: 'Disable' and 'Enable'. The 'Enable' radio button is selected and circled in red. An 'Apply' button is located at the bottom of the page.

Figure 24-12 AUTHENTICATION: Activate SSL Login

2. Click **Apply** to save the changes and restart the ZyAIR when prompted.

24.5 SSL Certificate Download

You can register for a certificate from a CA (Certificate Authority). A CA issues digital certificates and guarantees the identity of the certificate owner.

Click **SYSTEM TOOLS**, **SSL CERTIFICATE** to open the **SSL CERTIFICATE** screen. Use this screen to download a CA registered certificate from a computer connected to the ZyAIR.



You must save the certificate and private key files from the CA on a computer that is connected to the ZyAIR.

Figure 24-13 SSL CERTIFICATE

The following table describes the labels in this screen.

Table 24-1 SSL CERTIFICATE

LABEL	DESCRIPTION
Password	Enter the private key password from the CA. Make sure you enter it exactly as the CA provides.
Certificate File	Specify the name and/or location of the file containing the certificate. Or click Browse to locate the file.
Private Key File	Specify the name and/or location of the file containing the private key, Or click Browse to locate the file.
Apply	Click Apply to transfer the certificate and private key files from the computer to the ZyAIR.

After you download the certificate files, click **Apply** to restart the ZyAIR.



See the chapter on general system setup for how to set the ZyAIR to use the certificate that you download.

Chapter 25

Ping Command

*This chapter covers how to use the **PING COMMAND** screen.*

25.1 About Ping Command

Use the ping function to check the ZyAIR's network connection.

25.2 Using Ping Command

Click **SYSTEM TOOLS** and then **PING COMMAND** to open the following screen.

The following table describes the labels in this screen.

Table 25-1 PING COMMAND

LABEL	DESCRIPTION
Destination IP Address	Type the IP address of a device on the WAN that you want to ping in order to test the Internet connection.  This feature tests your Internet connection, so the destination IP address must be on the WAN. Do not use a LAN IP address.
Ping	Click this button to have the device ping the IP address.

Table 25-1 PING COMMAND

LABEL	DESCRIPTION
Clear	Click this button to clear the ping results in the multi-line text box.
Ping Result	This multi-line text box displays the results of the ping.

Chapter 26

Restart

*This chapter covers how to use the **RESTART** screen.*

26.1 Restart

Click **SYSTEM TOOLS** and then **RESTART** to open the following screen. Click **Apply** to have the ZyAIR reboot. This does not affect the ZyAIR's configuration.

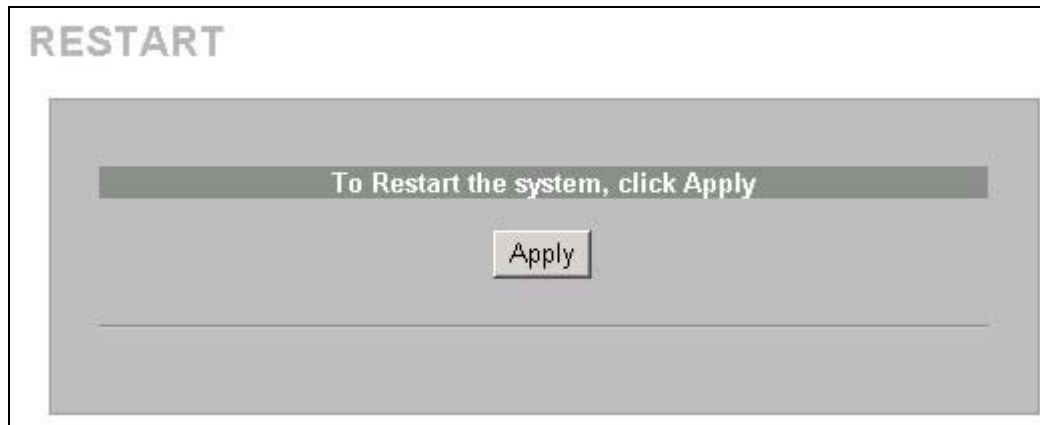

Chapter 27

Troubleshooting

This chapter covers potential problems and possible remedies. After each problem description, some instructions are provided to help you to diagnose and to solve the problem.

27.1 Using LEDs to Diagnose Problems

The LEDs are useful aides for finding possible problem causes.

27.1.1 The Power LED

The **PWR** LED on the front panel does not light up.

Table 27-1 Troubleshooting Power LED

STEPS	CORRECTIVE ACTION
1	Check the connection from the ZyAIR to the power source. Make sure you are using the supplied power supply. Refer to the product specifications.
2	Make sure the power source is turned on and that the ZyAIR is receiving sufficient power.
3	If these steps fail to correct the problem, contact your local distributor for assistance.

27.1.2 The LAN Port LEDs

None of the LEDs for the LAN port(s) light up when connected to an Ethernet device.

Table 27-2 Troubleshooting LAN LEDs

STEPS	CORRECTIVE ACTION
1	Make sure the ZyAIR is turned on.
2	Verify that the attached device(s) is turned on and properly connected to the ZyAIR.
3	Verify that the Ethernet cable length does not exceed 100 meters.
4	Make sure the network adapters are working on the attached device(s).

27.1.3 The WAN Port LED

The LED for the WAN port does not light up when connected to an Ethernet device.

Table 27-3 Troubleshooting WAN LEDs

STEPS	CORRECTIVE ACTION
1	Make sure you connect your cable or DSL modem or router to this port using the Ethernet cable that came with your cable or DSL modem or router.
2	Verify that the attached device is turned on and properly connected to the ZyAIR.
3	Verify that the Ethernet cable length does not exceed 100 meters.

27.2 Web Configurator

I cannot access the web configurator.

Table 27-4 Troubleshooting the Web Configurator

STEPS	CORRECTIVE ACTION
1	Make sure you are using either Internet Explorer (version 4.0 and later) or Netscape Navigator (version 6.0 and later).
2	Make sure you are using the correct WAN or LAN IP address. The default LAN IP address is 192.168.1.1 .
3	Make sure you entered the correct username and password. The default administrator username is "admin" and the default password is "1234". The username and password are case-sensitive. If you have forgotten the administrator user name and/or password, you must reset the ZyAIR back to the factory defaults using the reset button. Use a pointed object to press the reset button on the side panel to reset the ZyAIR. All of your custom configuration will be lost.
4	Ping the ZyAIR from your computer on the WAN or LAN. If you cannot ping the ZyAIR, check the IP addresses of the ZyAIR and your computer. Make sure that both IP addresses are in the same subnet.
5	Delete the temporary web files and log in again. In Internet Explorer, click Tools, Internet Options and then click the Delete Files ... button. When a Delete Files window displays, select Delete all offline content and click OK . (Steps may vary depending on the version of your Internet browser.) In Netscape, click Edit, Preference . Under Advanced category, click Cache . Click Clear Memory Cache and Clear Disk Cache . (Steps may vary depending on the version of your Internet browser.)
6	Disable any HTTP proxy settings in your web browser.

The web configurator does not display properly.

Table 27-5 Troubleshooting the Internet Browser Display

STEPS	CORRECTIVE ACTION
1	Make sure you are using either Internet Explorer (version 4.0 or above) or Netscape Navigator (6.0 or above). Make sure that your browser has JavaScript support enabled.
2	Delete the temporary web files and log in again. In Internet Explorer, click Tools, Internet Options and then click the Delete Files ... button. When a Delete Files window displays, select Delete all offline content and click OK . (Steps may vary depending on the version of your Internet browser.) In Netscape, click Edit, Preference . Under Advanced category, click Cache . Click Clear Memory Cache and Clear Disk Cache . (Steps may vary depending on the version of your Internet browser.)

27.3 Internet Access

A subscriber cannot connect to the Internet through the ZyAIR.

Table 27-6 Troubleshooting Internet Access

STEPS	CORRECTIVE ACTION
1	Check your Internet settings on your modem and/or router.
2	Make sure the subscriber enters the correct user name and password to log in to the ZyAIR. The user name and password are case sensitive.

Table 27-6 Troubleshooting Internet Access

3	Verify that the IP addresses and the subnet masks of the ZyAIR and the computers are on the same subnet.
4	Make sure the account is still valid.
5	Make sure there is no conflict in IP address assignment. Refer to the appendix.
6	For wireless clients, check that both the ZyAIR and wireless client(s) are using the same ESSID, channel and WEP key (if WEP encryption is activated).

27.4 Statement Printer



This section is applicable when you use an external statement printer.

I cannot print subscriber statements using a statement printer.

Table 27-7 Troubleshooting a Statement Printer

STEPS	CORRECTIVE ACTION
1	Make sure the statement printer is connected to a power source and is turned on.
2	Check that the statement printer is connected to the port labeled DEVICE PORT .
3	Make sure there is enough printing paper in the statement printer.
4	Make sure you set the ZyAIR to require authentication before allowing Internet access, see the Wizard Setup screens or the Authentication chapter.

Part VI:

Additional Information

This part provides contains background information on setting up your computer's IP address, IP address assignment conflicts, wireless LAN, PPPoE, PPTP, IP subnetting, subscriber login, and power and cable specifications and printing reports. It also provides an index of key terms.

Appendix A.

Setting up Your Computer's IP Address

All computers must have a 10M or 100M Ethernet adapter card and TCP/IP installed.

Windows 95/98/Me/NT/2000/XP, Macintosh OS 7 and later operating systems and all versions of UNIX/LINUX include the software components you need to install and use TCP/IP on your computer. Windows 3.1 requires the purchase of a third-party TCP/IP application package.

TCP/IP should already be installed on computers using Windows NT/2000/XP, Macintosh OS 7 and later operating systems.

After the appropriate TCP/IP components are installed, configure the TCP/IP settings in order to "communicate" with your network.

If you manually assign IP information instead of using dynamic assignment, make sure that your computers have IP addresses that place them in the same subnet as the ZyAIR's LAN port.

Windows 95/98/Me

Click **Start**, **Settings**, **Control Panel** and double-click the **Network** icon to open the **Network** window.

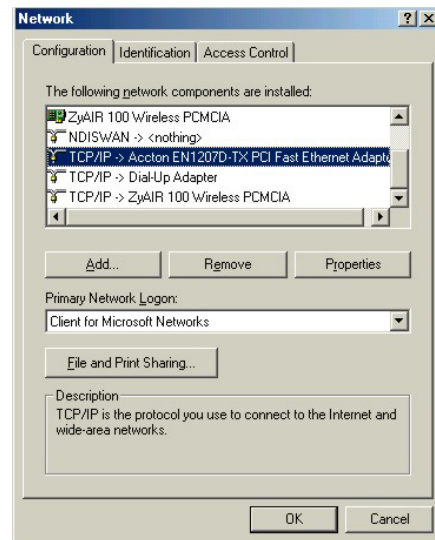

The **Network** window **Configuration** tab displays a list of installed components. You need a network adapter, the TCP/IP protocol and Client for Microsoft Networks.

If you need the adapter:

- a. In the **Network** window, click **Add**.
- b. Select **Adapter** and then click **Add**.
- c. Select the manufacturer and model of your network adapter and then click **OK**.

If you need TCP/IP:

- a. In the **Network** window, click **Add**.
- b. Select **Protocol** and then click **Add**.
- c. Select **Microsoft** from the list of **manufacturers**.
- d. Select **TCP/IP** from the list of network protocols and then click **OK**.

If you need Client for Microsoft Networks:

- a. Click **Add**.
- b. Select **Client** and then click **Add**.
- c. Select **Microsoft** from the list of manufacturers.
- d. Select **Client for Microsoft Networks** from the list of network clients and then click **OK**.
- e. Restart your computer so the changes you made take effect.

In the **Network** window **Configuration** tab, select your network adapter's TCP/IP entry and click **Properties**.

1. Click the **IP Address** tab.

-If your IP address is dynamic, select **Obtain an IP address automatically**.

-If you have a static IP address, select **Specify an IP address** and type your information into the **IP Address** and **Subnet Mask** fields.

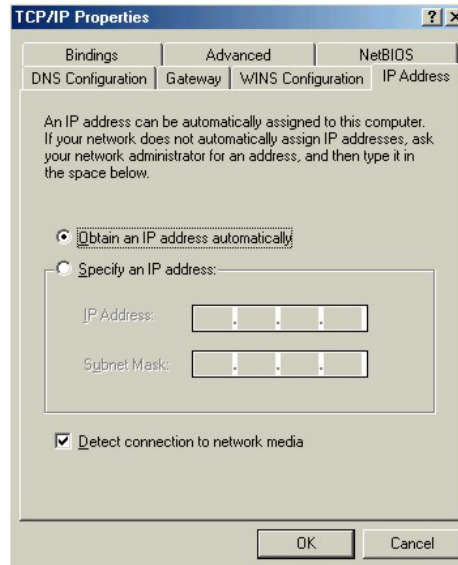

2. Click the **DNS Configuration** tab.

-If you do not know your DNS information, select **Disable DNS**.

-If you know your DNS information, select **Enable DNS** and type the information in the fields below (you may not need to fill them all in).

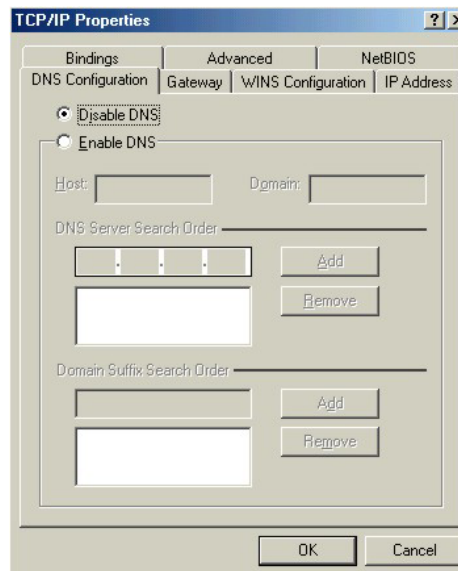

3. Click the **Gateway** tab.
 - If you do not know your gateway's IP address, remove previously installed gateways.
 - If you have a gateway IP address, type it in the **New gateway field** and click **Add**.

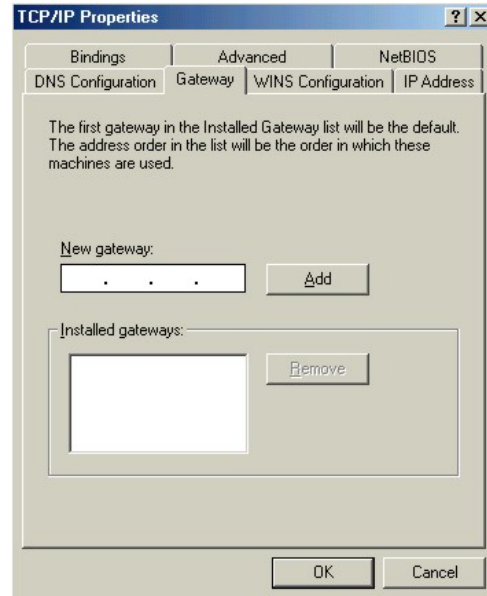

4. Click **OK** to save and close the **TCP/IP Properties** window.
5. Click **OK** to close the **Network** window. Insert the Windows CD if prompted.
6. Turn on your ZyAIR and restart your computer when prompted.

Verifying Your Computer's IP Address

1. Click **Start** and then **Run**.
2. In the **Run** window, type "winipcfg" and then click **OK** to open the **IP Configuration** window.
3. Select your network adapter. You should see your computer's IP address, subnet mask and default gateway.

Windows 2000/NT/XP

1. For Windows XP, click **start**, **Control Panel**. In Windows 2000/NT, click **Start, Settings, Control Panel**.

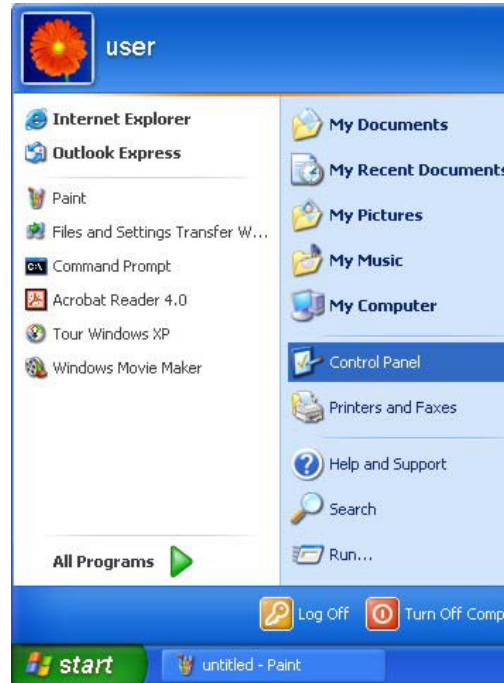

2. In the **Control Panel**, double-click **Network Connections (Network and Dial-up Connections)** in Windows 2000/NT).



3. Right-click **Local Area Connection** and then click **Properties**.

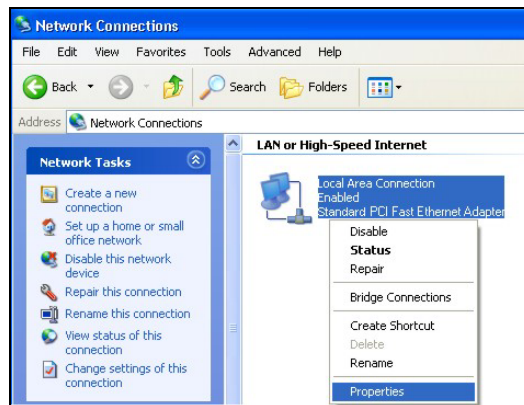

4. Select **Internet Protocol (TCP/IP)** (under the **General** tab in Win XP) and click **Properties**.

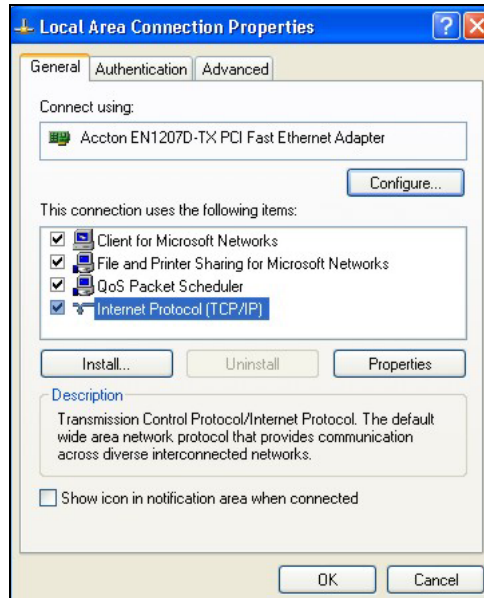

5. The **Internet Protocol TCP/IP Properties** window opens (the **General** tab in Windows XP).

-If you have a dynamic IP address click **Obtain an IP address automatically**.

-If you have a static IP address click **Use the following IP Address** and fill in the **IP address**, **Subnet mask**, and **Default gateway** fields.

Click **Advanced**.

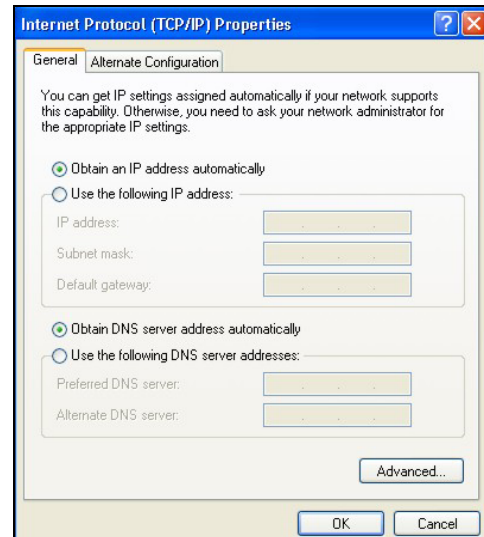

6. -If you do not know your gateway's IP address, remove any previously installed gateways in the **IP Settings** tab and click **OK**.

Do one or more of the following if you want to configure additional IP addresses:

-In the **IP Settings** tab, in IP addresses, click **Add**.

-In **TCP/IP Address**, type an IP address in **IP address** and a subnet mask in **Subnet mask**, and then click **Add**.

-Repeat the above two steps for each IP address you want to add.

-Configure additional default gateways in the **IP Settings** tab by clicking **Add** in **Default gateways**.

-In **TCP/IP Gateway Address**, type the IP address of the default gateway in **Gateway**. To manually configure a default metric (the number of transmission hops), clear the **Automatic metric** check box and type a metric in **Metric**.

-Click **Add**.

-Repeat the previous three steps for each default gateway you want to add.

-Click **OK** when finished.

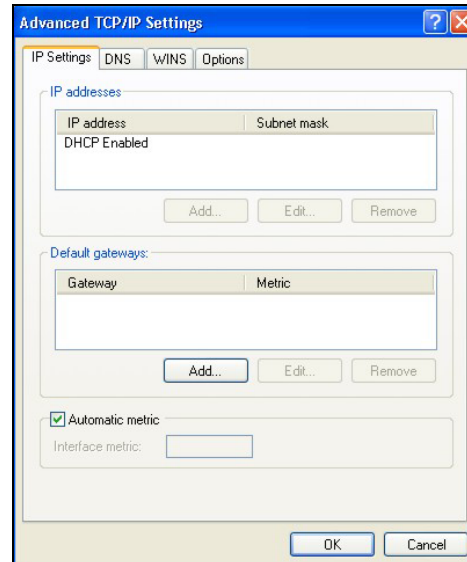

7. In the **Internet Protocol TCP/IP Properties** window (the **General** tab in Windows XP):

-Click **Obtain DNS server address automatically** if you do not know your DNS server IP address(es).

-If you know your DNS server IP address(es), click **Use the following DNS server addresses**, and type them in the **Preferred DNS server** and **Alternate DNS server** fields.

If you have previously configured DNS servers, click **Advanced** and then the **DNS** tab to order them.

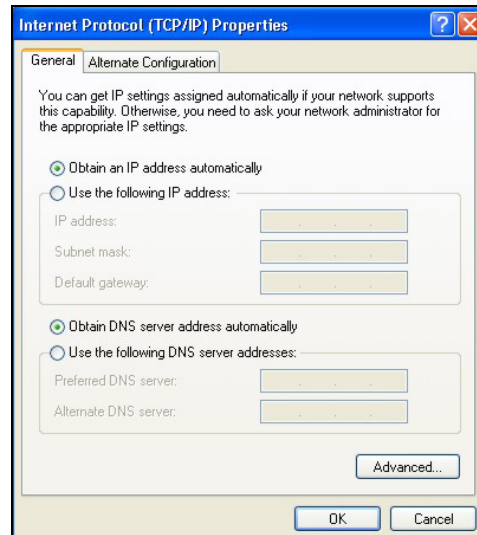

8. Click **OK** to close the **Internet Protocol (TCP/IP) Properties** window.
9. Click **Close (OK** in Windows 2000/NT) to close the **Local Area Connection Properties** window.
10. Close the **Network Connections** window (**Network and Dial-up Connections** in Windows 2000/NT).
11. Turn on your ZyAIR and restart your computer (if prompted).

Verifying Your Computer's IP Address

1. Click **Start, All Programs, Accessories** and then **Command Prompt**.
2. In the **Command Prompt** window, type "ipconfig" and then press [ENTER]. You can also open **Network Connections**, right-click a network connection, click **Status** and then click the **Support** tab.

Macintosh OS 8/9

1. Click the **Apple** menu, **Control Panel** and double-click **TCP/IP** to open the **TCP/IP Control Panel**.



2. Select **Ethernet built-in** from the **Connect via** list.

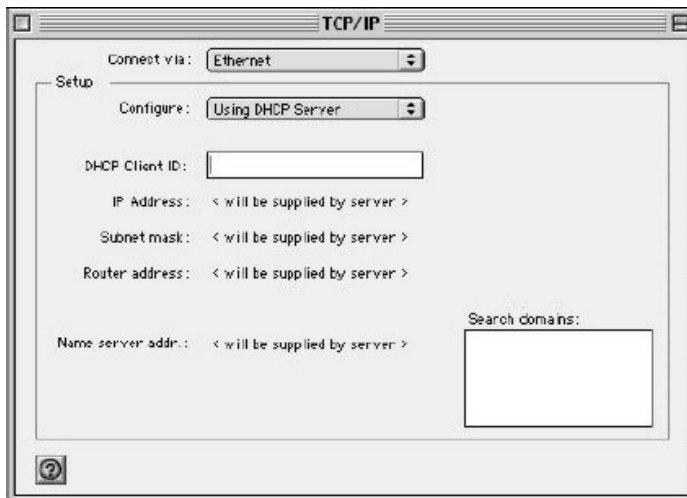

3. For dynamically assigned settings, select **Using DHCP Server** from the **Configure:** list.
4. For statically assigned settings, do the following:
 - From the **Configure** box, select **Manually**.
 - Type your IP address in the **IP Address** box.
 - Type your subnet mask in the **Subnet mask** box.
 - Type the IP address of your ZyAIR in the **Router address** box.
5. Close the **TCP/IP Control Panel**.
6. Click **Save** if prompted, to save changes to your configuration.
7. Turn on your ZyAIR and restart your computer (if prompted).

Verifying Your Computer's IP Address

Check your TCP/IP properties in the **TCP/IP Control Panel** window.

Macintosh OS X

1. Click the **Apple** menu, and click **System Preferences** to open the **System Preferences** window.

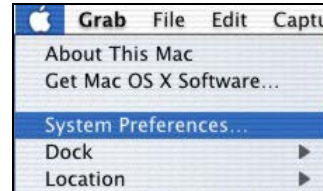

2. Click **Network** in the icon bar.
 - Select **Automatic** from the **Location** list.
 - Select **Built-in Ethernet** from the **Show** list.
 - Click the **TCP/IP** tab.

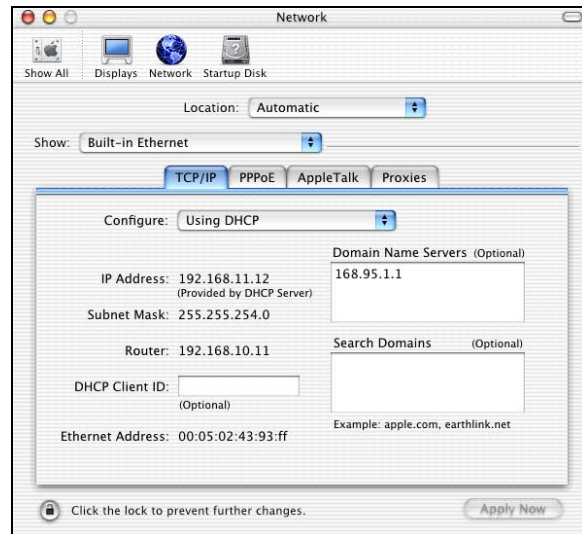

3. For dynamically assigned settings, select **Using DHCP** from the **Configure** list.
4. For statically assigned settings, do the following:
 - From the **Configure** box, select **Manually**.
 - Type your IP address in the **IP Address** box.
 - Type your subnet mask in the **Subnet mask** box.
 - Type the IP address of your ZyAIR in the **Router address** box.
5. Click **Apply Now** and close the window.
6. Turn on your ZyAIR and restart your computer (if prompted).

Verifying Your Computer's IP Address

Check your TCP/IP properties in the **Network** window.

Appendix B. IP Address Assignment Conflicts

This appendix describes situations where IP address conflicts may occur. Subscribers with duplicate IP addresses will not be able to access the Internet.

Case A: The ZyAIR is Using the Same LAN and WAN IP Addresses

The following figure shows an example where the ZyAIR is using a WAN IP address that is the same as the IP address of a computer on the LAN.

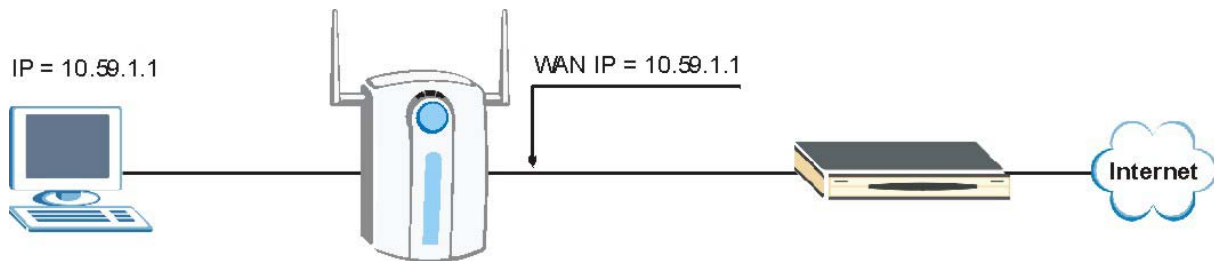

Diagram 1 IP Address Conflicts: Case A

You must set the ZyAIR to use different LAN and WAN IP addresses on different subnets if you enable DHCP server on the ZyAIR. For example, you set the WAN IP address to 192.59.1.1 and the LAN IP address to 10.59.1.1. Otherwise, it is recommended the ZyAIR use a public WAN IP address.

Case B: The ZyAIR LAN IP Address Conflicts with the DHCP Client IP Address

In the following figure, the ZyAIR is acting as a DHCP server. The ZyAIR assigns an IP address, which is the same as its LAN port IP address, to a DHCP client attached to the LAN.

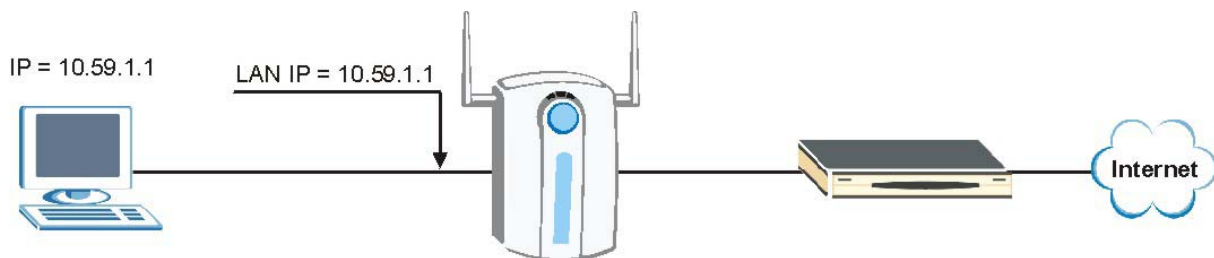

Diagram 2 IP Address Conflicts: Case B

To solve this problem, make sure the ZyAIR LAN IP address is not in the DHCP IP address pool.

Case C: The Subscriber IP Address is the Same as the IP Address of a Network Device

The following figure depicts an example where the subscriber IP address is the same as the IP address of a network device not attached to the ZyAIR.

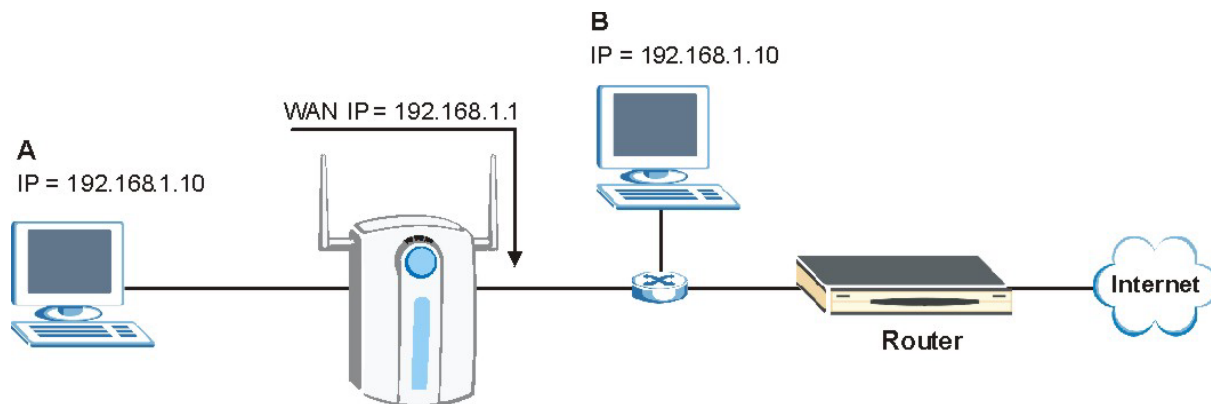

Diagram 3 IP Address Conflicts: Case C

You must set the ZyAIR to use different LAN and WAN IP addresses on different subnets if you enable DHCP server on the ZyAIR. For example, you set the WAN IP address to 192.59.1.1 and the LAN IP address to 10.59.1.1. Otherwise, It is recommended the ZyAIR use a public WAN IP address.

Case D: Two or More Subscribers Have the Same IP Address.

By converting all private IP addresses to the WAN IP address, the ZyAIR allows subscribers with different network configurations to access the Internet. However, there are situations where two or more subscribers are using the same private IP address. This may happen when a subscriber is configured to use a static (or fixed) IP address that is the same as the IP address the ZyAIR DHCP server assigns to another subscriber acting as a DHCP client.

In this case, the subscribers are not able to access the Internet.

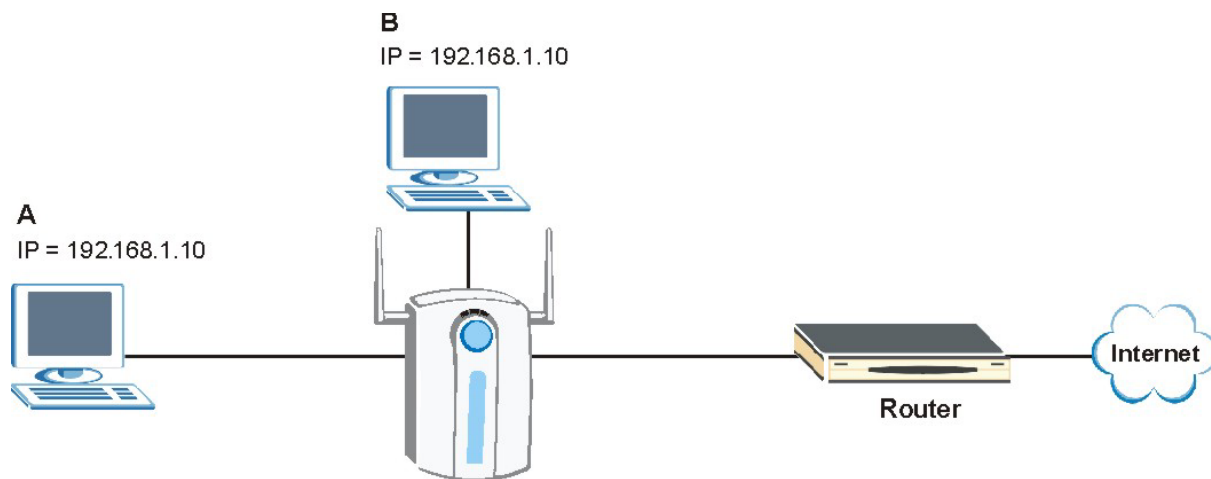

Diagram 4 IP Address Conflicts: Case D

This problem can be solved by adding a VLAN-enabled switch or set the computers to obtain IP addresses dynamically.

Appendix C.

Wireless LAN and IEEE 802.11

A wireless LAN (WLAN) provides a flexible data communications system that you can use to access various services (navigating the Internet, email, printer services, etc.) without the use of a cabled connection. In effect a wireless LAN environment provides you the freedom to stay connected to the network while roaming around in the coverage area. WLAN is not available on all models.

Benefits of a Wireless LAN

Wireless LAN offers the following benefits:

1. It provides you with access to network services in areas otherwise hard or expensive to wire, such as historical buildings, buildings with asbestos materials and classrooms.
2. It provides healthcare workers like doctors and nurses access to a complete patient's profile on a handheld or notebook computer upon entering a patient's room.
3. It allows flexible workgroups a lower total cost of ownership for workspaces that are frequently reconfigured.
4. It allows conference room users access to the network as they move from meeting to meeting, getting up-to-date access to information and the ability to communicate decisions while "on the go".
5. It provides campus-wide networking mobility, allowing enterprises the roaming capability to set up easy-to-use wireless networks that cover the entire campus transparently.

IEEE 802.11

The 1997 completion of the IEEE 802.11 standard for wireless LANs (WLANs) was a first important step in the evolutionary development of wireless networking technologies. The standard was developed to maximize interoperability between differing brands of wireless LANs as well as to introduce a variety of performance improvements and benefits. On September 16, 1999, the 802.11g provided much higher data rates of up to 11Mbps, while maintaining the 802.11 protocol.

The IEEE 802.11 specifies three different transmission methods for the PHY, the layer responsible for transferring data between nodes. Two of the methods use spread spectrum RF signals, Direct Sequence Spread Spectrum (DSSS) and Frequency-Hopping Spread Spectrum (FHSS), in the 2.4 to 2.4825 GHz unlicensed ISM (Industrial, Scientific and Medical) band. The third method is infrared technology, using very high frequencies, just below visible light in the electromagnetic spectrum to carry data.

Ad-hoc Wireless LAN Configuration

The simplest WLAN configuration is an independent (Ad-hoc) WLAN that connects a set of computers with wireless nodes or stations (STA), which is called a Basic Service Set (BSS). In the

most basic form, a wireless LAN connects a set of computers with wireless adapters. Any time two or more wireless adapters are within range of each other, they can set up an independent network, which is commonly referred to as an Ad-hoc network or Independent Basic Service Set (IBSS). See the following diagram of an example of an Ad-hoc wireless LAN.

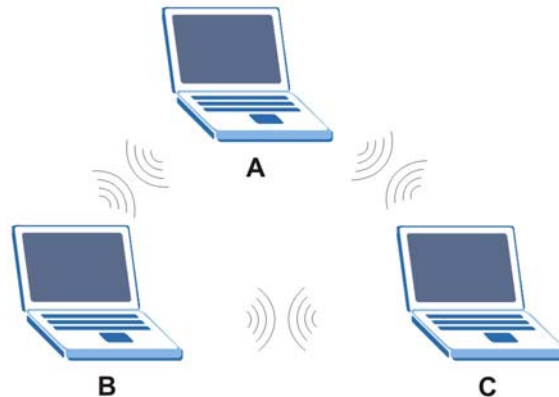

Diagram 5 Peer-to-Peer Communication in an Ad-hoc Network

Infrastructure Wireless LAN Configuration

For infrastructure WLANs, multiple access points (APs) link the WLAN to the wired network and allow users to efficiently share network resources. The access points not only provide communication with the wired network but also mediate wireless network traffic in the immediate neighborhood. Multiple access points can provide wireless coverage for an entire building or campus. All communications between stations or between a station and a wired network client go through the access point.

The Extended Service Set (ESS) shown in the next figure consists of a series of overlapping BSSs (each containing an Access Point) connected together by means of a Distribution System (DS). Although the DS could be any type of network, it is almost invariably an Ethernet LAN. Mobile nodes can roam between access points and seamless campus-wide coverage is possible.

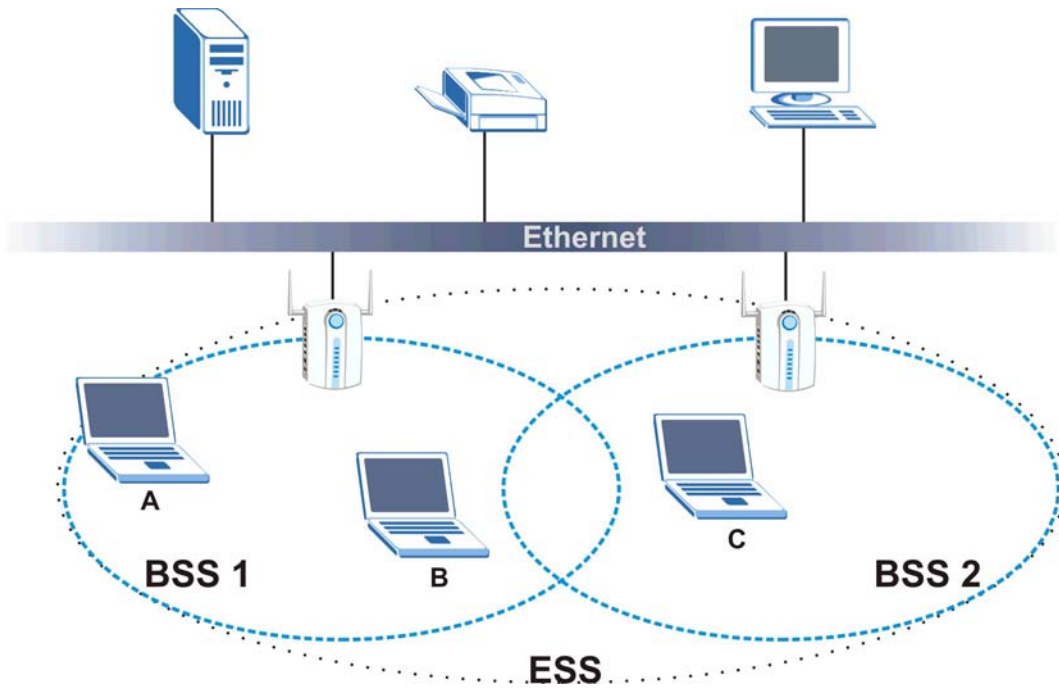

Diagram 6 ESS Provides Campus-Wide Coverage

Appendix D.

General Antenna Information

An antenna couples RF signals onto air. A transmitter within a wireless device sends an RF signal to the antenna, which propagates the signal through the air. The antenna also operates in reverse by capturing RF signals from the air.

Positioning the antennas properly increases the range and coverage area of a wireless LAN.

Antenna Characteristics

➤ Frequency

An antenna in the frequency of 2.4GHz (IEEE 802.11g) or 5GHz(IEEE 802.11a) is needed to communicate efficiently in a wireless LAN.

➤ Radiation Pattern

A radiation pattern is a diagram that allows you to visualize the shape of the antenna's coverage area.

➤ Antenna Gain

Antenna gain, measured in dB (decibel), is the increase in coverage within the RF beam width. Higher antenna gain improves the range of the signal for better communications.

For an indoor site, each 1 dB increase in antenna gain results in a range increase of approximately 2.5%. For an unobstructed outdoor site, each 1dB increase in gain results in a range increase of approximately 5%. Actual results may vary depending on the network environment.

Antenna gain is sometimes specified in dBi, which is how much the antenna increases the signal power compared to using an isotropic antenna. An isotropic antenna is a theoretical perfect antenna that sends out radio signals equally well in all directions. dBi represents the true gain that the antenna provides.

Types of Antennas For WLAN

There are two types of antennas used for wireless LAN applications.

- Omni-directional antennas send the RF signal out in all directions on a horizontal plane. The coverage area is torus-shaped (like a donut) which makes these antennas ideal for a room environment. With a wide coverage area, it is possible to make circular overlapping coverage areas with multiple access points.
- Directional antennas concentrate the RF signal in a beam, like a flashlight does with the light from its bulb. The angle of the beam determines the width of the coverage pattern. Angles typically range from 20 degrees (very directional) to 120 degrees (less directional). Directional antennas are ideal for hallways and outdoor point-to-point applications.

Positioning Antennas

In general, antennas should be mounted as high as practically possible and free of obstructions. In point-to-point application, position both transmitting and receiving antenna at the same height and in a direct line of sight to each other to attend the best performance.

For omni-directional antennas mounted on a table, desk, and so on, point the antenna up. For omni-directional antennas mounted on a wall or ceiling, point the antenna down. For a single AP application, place omni-directional antennas as close to the center of the coverage area as possible.

For directional antennas, point the antenna in the direction of the desired coverage area.

Connector Type

The ZyAIR is equipped with reverse polarity SMA jacks. 2.4GHz wireless antennas with reverse polarity SMA plugs are included.

Appendix E.

PPPoE

PPPoE in Action

An ADSL modem bridges a PPP session over Ethernet (PPP over Ethernet, RFC 2516) from your PC to an ATM PVC (Permanent Virtual Circuit), which connects to a DSL Access Concentrator where the PPP session terminates (see the next figure). One PVC can support any number of PPP sessions from your LAN. PPPoE provides access control and billing functionality in a manner similar to dial-up services using PPP.

Benefits of PPPoE

PPPoE offers the following benefits:

1. It provides you with a familiar dial-up networking (DUN) user interface.
2. It lessens the burden on the carriers of provisioning virtual circuits all the way to the ISP on multiple switches for thousands of users. For GSTN (PSTN & ISDN), the switching fabric is already in place.
3. It allows the ISP to use the existing dial-up model to authenticate and (optionally) to provide differentiated services.

Traditional Dial-up Scenario

The following diagram depicts a typical hardware configuration where the PCs use traditional dial-up networking.

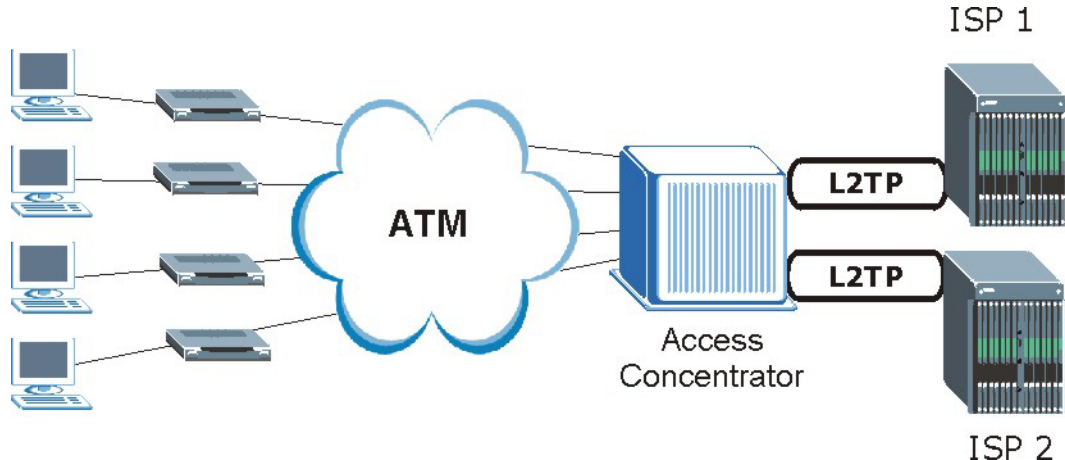

Diagram 7 Single-PC per Modem Hardware Configuration

How PPPoE Works

The PPPoE driver makes the Ethernet appear as a serial link to the PC and the PC runs PPP over it, while the modem bridges the Ethernet frames to the Access Concentrator (AC). Between the AC and an ISP, the AC is acting as a L2TP (Layer 2 Tunneling Protocol) LAC (L2TP Access Concentrator) and tunnels the PPP frames to the ISP. The L2TP tunnel is capable of carrying multiple PPP sessions.

With PPPoE, the VC (Virtual Circuit) is equivalent to the dial-up connection and is between the modem and the AC, as opposed to all the way to the ISP. However, the PPP negotiation is between the PC and the ISP.

ZyAIR as a PPPoE Client

When using the ZyAIR as a PPPoE client, the PCs on the LAN see only Ethernet and are not aware of PPPoE. This alleviates the administrator from having to manage the PPPoE clients on the individual PCs.

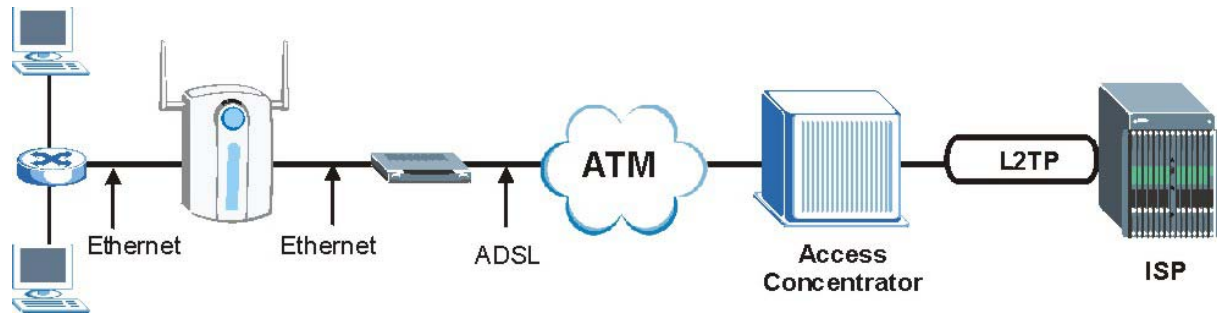

Diagram 8 ZyAIR as a PPPoE Client

Appendix F. PPTP

What is PPTP?

PPTP (Point-to-Point Tunneling Protocol) is a Microsoft proprietary protocol (RFC 2637 for PPTP is informational only) to tunnel PPP frames.

How can we transport PPP frames from a PC to a broadband modem over Ethernet?

A solution is to build PPTP into the ANT (ADSL Network Termination) where PPTP is used only over the short haul between the PC and the modem over Ethernet. For the rest of the connection, the PPP frames are transported with PPP over AAL5 (RFC 2364). The PPP connection, however, is still between the PC and the ISP. The various connections in this setup are depicted in the following diagram. The drawback of this solution is that it requires one separate ATM VC per destination.

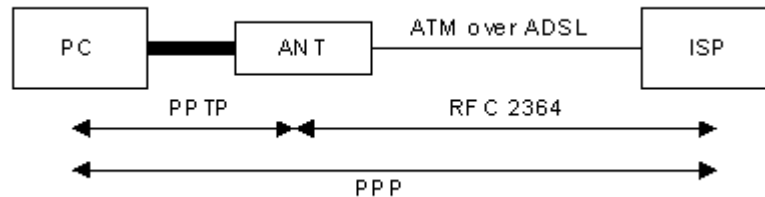

Diagram 9 Transport PPP frames over Ethernet

PPTP and the ZyAIR

When the ZyAIR is deployed in such a setup, it appears as a PC to the ANT.

In Windows VPN or PPTP Pass-Through feature, the PPTP tunneling is created from Windows 95, 98 and NT clients to an NT server in a remote location. The pass-through feature allows users on the network to access a different remote server using the ZyAIR's Internet connection. In NAT mode, the ZyAIR is able to pass the PPTP packets to the internal PPTP server (i.e. NT server) behind the NAT. Users need to forward PPTP packets to port 1723 by configuring the server in **Menu 15.2 - Server Set Setup**. In the case above as the remote PPTP Client initializes the PPTP connection, the user must configure the PPTP clients. The ZyAIR initializes the PPTP connection hence; there is no need to configure the remote PPTP clients.

PPTP Protocol Overview

PPTP is very similar to L2TP, since L2TP is based on both PPTP and L2F (Cisco's Layer 2 Forwarding). Conceptually, there are three parties in PPTP, namely the PNS (PPTP Network Server), the PAC (PPTP Access Concentrator) and the PPTP user. The PNS is the box that hosts both the PPP and the PPTP stacks and forms one end of the PPTP tunnel. The PAC is the box that dials/answers the phone calls and relays the PPP frames to the PNS. The PPTP user is not necessarily a PPP client (can be a PPP server too). Both the PNS and the PAC must have IP connectivity; however, the PAC must in addition have dial-up capability. The phone call is between the user and the PAC and the PAC

tunnels the PPP frames to the PNS. The PPTP user is unaware of the tunnel between the PAC and the PNS.



Diagram 10 PPTP Protocol Overview

Microsoft includes PPTP as a part of the Windows OS. In Microsoft's implementation, the PC, and hence the ZyAIR, is the PNS that requests the PAC (the ANT) to place an outgoing call over AAL5 to an RFC 2364 server.

Control & PPP connections

Each PPTP session has distinct control connection and PPP data connection.

Call Connection

The control connection runs over TCP. Similar to L2TP, a tunnel control connection is first established before call control messages can be exchanged. Please note that a tunnel control connection supports multiple call sessions.

The following diagram depicts the message exchange of a successful call setup between a PC and an ANT.

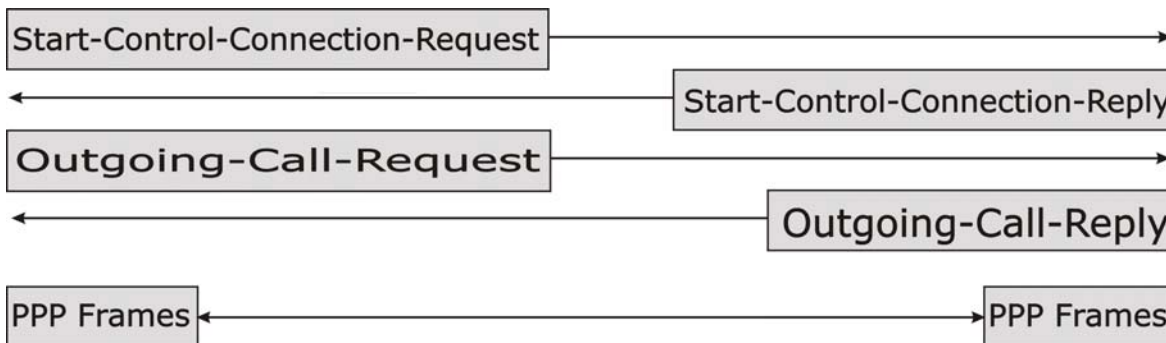

Diagram 11 Example Message Exchange between PC and an ANT

PPP Data Connection

The PPP frames are tunneled between the PNS and PAC over GRE (General Routing Encapsulation, RFC 1701, 1702). The individual calls within a tunnel are distinguished using the Call ID field in the GRE header.

Appendix G.

IP Subnetting

IP Addressing

Routers “route” based on the network number. The router that delivers the data packet to the correct destination host uses the host ID.

IP Classes

An IP address is made up of four octets (eight bits), written in dotted decimal notation, for example, 192.168.1.1. IP addresses are categorized into different classes. The class of an address depends on the value of its first octet.

- Class “A” addresses have a 0 in the left most bit. In a class “A” address the first octet is the network number and the remaining three octets make up the host ID.
- Class “B” addresses have a 1 in the left most bit and a 0 in the next left most bit. In a class “B” address the first two octets make up the network number and the two remaining octets make up the host ID.
- Class “C” addresses begin (starting from the left) with 1 1 0. In a class “C” address the first three octets make up the network number and the last octet is the host ID.
- Class “D” addresses begin with 1 1 1 0. Class “D” addresses are used for multicasting. (There is also a class “E” address. It is reserved for future use.)

Chart 1 Classes of IP Addresses

IP ADDRESS:		OCTET 1	OCTET 2	OCTET 3	OCTET 4
Class A	0	Network number	Host ID	Host ID	Host ID
Class B	10	Network number	Network number	Host ID	Host ID
Class C	110	Network number	Network number	Network number	Host ID



Host IDs of all zeros or all ones are not allowed.

Therefore:

- A class “C” network (8 host bits) can have $2^8 - 2$ or 254 hosts.
- A class “B” address (16 host bits) can have $2^{16} - 2$ or 65534 hosts.

A class “A” address (24 host bits) can have $2^{24} - 2$ hosts (approximately 16 million hosts).

Since the first octet of a class “A” IP address must contain a “0”, the first octet of a class “A” address can have a value of 0 to 127.

Similarly the first octet of a class “B” must begin with “10”, therefore the first octet of a class “B” address has a valid range of 128 to 191. The first octet of a class “C” address begins with “110”, and therefore has a range of 192 to 223.

Chart 2 Allowed IP Address Range By Class

CLASS	ALLOWED RANGE OF FIRST OCTET (BINARY)	ALLOWED RANGE OF FIRST OCTET (DECIMAL)
Class A	00000000 to 01111111	0 to 127
Class B	10000000 to 10111111	128 to 191
Class C	11000000 to 11011111	192 to 223
Class D	11100000 to 11101111	224 to 239

Subnet Masks

A subnet mask is used to determine which bits are part of the network number, and which bits are part of the host ID (using a logical AND operation). A subnet mask has 32 bits; each bit of the mask corresponds to a bit of the IP address. If a bit in the subnet mask is a “1” then the corresponding bit in the IP address is part of the network number. If a bit in the subnet mask is “0” then the corresponding bit in the IP address is part of the host ID.

Subnet masks are expressed in dotted decimal notation just as IP addresses are. The “natural” masks for class A, B and C IP addresses are as follows.

Chart 3 “Natural” Masks

CLASS	NATURAL MASK
A	255.0.0.0
B	255.255.0.0
C	255.255.255.0

Subnetting

With subnetting, the class arrangement of an IP address is ignored. For example, a class C address no longer has to have 24 bits of network number and 8 bits of host ID. With subnetting, some of the host ID bits are converted into network number bits. By convention, subnet masks always consist of a continuous sequence of ones beginning from the left most bit of the mask, followed by a continuous sequence of zeros, for a total number of 32 bits.

Since the mask is always a continuous number of ones beginning from the left, followed by a continuous number of zeros for the remainder of the 32 bit mask, you can simply specify the number of ones instead of writing the value of each octet. This is usually specified by writing a “/” followed by the number of bits in the mask after the address.

For example, 192.1.1.0 /25 is equivalent to saying 192.1.1.0 with mask 255.255.255.128.

The following table shows all possible subnet masks for a class “C” address using both notations.

Chart 4 Alternative Subnet Mask Notation

SUBNET MASK IP ADDRESS	SUBNET MASK “1” BITS	LAST OCTET BIT VALUE
255.255.255.0	/24	0000 0000
255.255.255.128	/25	1000 0000
255.255.255.192	/26	1100 0000
255.255.255.224	/27	1110 0000
255.255.255.240	/28	1111 0000

Chart 4 Alternative Subnet Mask Notation

SUBNET MASK IP ADDRESS	SUBNET MASK "1" BITS	LAST OCTET BIT VALUE
255.255.255.248	/29	1111 1000
255.255.255.252	/30	1111 1100

The first mask shown is the class "C" natural mask. Normally if no mask is specified it is understood that the natural mask is being used.

Example: Two Subnets

As an example, you have a class "C" address 192.168.1.0 with subnet mask of 255.255.255.0.

	NETWORK NUMBER	HOST ID
IP Address	192.168.1.	0
IP Address (Binary)	11000000.10101000.00000001.	00000000
Subnet Mask	255.255.255.	0
Subnet Mask (Binary)	11111111.11111111.11111111.	00000000

The first three octets of the address make up the network number (class "C"). You want to have two separate networks.

Divide the network 192.168.1.0 into two separate subnets by converting one of the host ID bits of the IP address to a network number bit. The "borrowed" host ID bit can be either "0" or "1" thus giving two subnets; 192.168.1.0 with mask 255.255.255.128 and 192.168.1.128 with mask 255.255.255.128.



In the following charts, shaded/bolded last octet bit values indicate host ID bits "borrowed" to form network ID bits. The number of "borrowed" host ID bits determines the number of subnets you can have. The remaining number of host ID bits (after "borrowing") determines the number of hosts you can have on each subnet.

Chart 5 Subnet 1

	NETWORK NUMBER	LAST OCTET BIT VALUE
IP Address	192.168.1.	0
IP Address (Binary)	11000000.10101000.00000001.	0 0000000
Subnet Mask	255.255.255.	128
Subnet Mask (Binary)	11111111.11111111.11111111.	1 0000000
Subnet Address: 192.168.1.0	Lowest Host ID: 192.168.1.1	
Broadcast Address: 192.168.1.127	Highest Host ID: 192.168.1.126	

Chart 6 Subnet 2

	NETWORK NUMBER	LAST OCTET BIT VALUE
IP Address	192.168.1.	128
IP Address (Binary)	11000000.10101000.00000001.	1 0000000

Chart 6 Subnet 2

	NETWORK NUMBER	LAST OCTET BIT VALUE
Subnet Mask	255.255.255.	128
Subnet Mask (Binary)	11111111.11111111.11111111.	10000000
Subnet Address: 192.168.1.128	Lowest Host ID: 192.168.1.129	
Broadcast Address: 192.168.1.255	Highest Host ID: 192.168.1.254	

The remaining 7 bits determine the number of hosts each subnet can have. Host IDs of all zeros represent the subnet itself and host IDs of all ones are the broadcast address for that subnet, so the actual number of hosts available on each subnet in the example above is $2^7 - 2$ or 126 hosts for each subnet.

192.168.1.0 with mask 255.255.255.128 is the subnet itself, and 192.168.1.127 with mask 255.255.255.128 is the directed broadcast address for the first subnet. Therefore, the lowest IP address that can be assigned to an actual host for the first subnet is 192.168.1.1 and the highest is 192.168.1.126. Similarly the host ID range for the second subnet is 192.168.1.129 to 192.168.1.254.

Example: Four Subnets

The above example illustrated using a 25-bit subnet mask to divide a class “C” address space into two subnets. Similarly to divide a class “C” address into four subnets, you need to “borrow” two host ID bits to give four possible combinations of 00, 01, 10 and 11. The subnet mask is 26 bits (11111111.11111111.11111111.11000000) or 255.255.255.192. Each subnet contains 6 host ID bits, giving $2^6 - 2$ or 62 hosts for each subnet (all 0’s is the subnet itself, all 1’s is the broadcast address on the subnet).

Chart 7 Subnet 1

	NETWORK NUMBER	LAST OCTET BIT VALUE
IP Address	192.168.1.	0
IP Address (Binary)	11000000.10101000.00000001.	00000000
Subnet Mask (Binary)	11111111.11111111.11111111.	11000000
Subnet Address: 192.168.1.0	Lowest Host ID: 192.168.1.1	
Broadcast Address: 192.168.1.63	Highest Host ID: 192.168.1.62	

Chart 8 Subnet 2

	NETWORK NUMBER	LAST OCTET BIT VALUE
IP Address	192.168.1.	64
IP Address (Binary)	11000000.10101000.00000001.	01000000
Subnet Mask (Binary)	11111111.11111111.11111111.	11000000
Subnet Address: 192.168.1.64	Lowest Host ID: 192.168.1.65	
Broadcast Address: 192.168.1.127	Highest Host ID: 192.168.1.126	

Chart 9 Subnet 3

	NETWORK NUMBER	LAST OCTET BIT VALUE
IP Address	192.168.1.	128
IP Address (Binary)	11000000.10101000.00000001.	10 000000
Subnet Mask (Binary)	11111111.11111111.11111111.	11 000000
Subnet Address: 192.168.1.128	Lowest Host ID: 192.168.1.129	
Broadcast Address: 192.168.1.191	Highest Host ID: 192.168.1.190	

Chart 10 Subnet 4

	NETWORK NUMBER	LAST OCTET BIT VALUE
IP Address	192.168.1.	192
IP Address (Binary)	11000000.10101000.00000001.	11 000000
Subnet Mask (Binary)	11111111.11111111.11111111.	11 000000
Subnet Address: 192.168.1.192	Lowest Host ID: 192.168.1.193	
Broadcast Address: 192.168.1.255	Highest Host ID: 192.168.1.254	

Example Eight Subnets

Similarly use a 27-bit mask to create 8 subnets (001, 010, 011, 100, 101, 110).

The following table shows class C IP address last octet values for each subnet.

Chart 11 Eight Subnets

SUBNET	SUBNET ADDRESS	FIRST ADDRESS	LAST ADDRESS	BROADCAST ADDRESS
1	0	1	30	31
2	32	33	62	63
3	64	65	94	95
4	96	97	126	127
5	128	129	158	159
6	160	161	190	191
7	192	193	222	223
8	224	225	254	255

The following table is a summary for class "C" subnet planning.

Chart 12 Class C Subnet Planning

NO. "BORROWED" HOST BITS	SUBNET MASK	NO. SUBNETS	NO. HOSTS PER SUBNET
1	255.255.255.128 (/25)	2	126
2	255.255.255.192 (/26)	4	62

Chart 12 Class C Subnet Planning

NO. "BORROWED" HOST BITS	SUBNET MASK	NO. SUBNETS	NO. HOSTS PER SUBNET
3	255.255.255.224 (/27)	8	30
4	255.255.255.240 (/28)	16	14
5	255.255.255.248 (/29)	32	6
6	255.255.255.252 (/30)	64	2
7	255.255.255.254 (/31)	128	1

Subnetting With Class A and Class B Networks.

For class "A" and class "B" addresses the subnet mask also determines which bits are part of the network number and which are part of the host ID.

A class "B" address has two host ID octets available for subnetting and a class "A" address has three host ID octets (see *Chart J-1*) available for subnetting.

The following table is a summary for class "B" subnet planning.

Chart 13 Class B Subnet Planning

NO. "BORROWED" HOST BITS	SUBNET MASK	NO. SUBNETS	NO. HOSTS PER SUBNET
1	255.255.128.0 (/17)	2	32766
2	255.255.192.0 (/18)	4	16382
3	255.255.224.0 (/19)	8	8190
4	255.255.240.0 (/20)	16	4094
5	255.255.248.0 (/21)	32	2046
6	255.255.252.0 (/22)	64	1022
7	255.255.254.0 (/23)	128	510
8	255.255.255.0 (/24)	256	254
9	255.255.255.128 (/25)	512	126
10	255.255.255.192 (/26)	1024	62
11	255.255.255.224 (/27)	2048	30
12	255.255.255.240 (/28)	4096	14
13	255.255.255.248 (/29)	8192	6
14	255.255.255.252 (/30)	16384	2
15	255.255.255.254 (/31)	32768	1

Appendix H. Subscriber Login

To log in as a subscriber, enter a web site address such as www.zyxel.com in a web browser.

If user authentication is activated, the login screen displays prompting you to enter the user name and password. A standard subscriber login screen (with the credit card function) is shown in the figure below.



The image shows a web browser window titled "Welcome" for "Hot Spot Internet Service". It features a login form with two input fields: "Username:" and "Password:". Below the form are "Enter" and "Cancel" buttons. At the bottom, there is a link "or Click here to pay by credit card" and logos for VISA, MasterCard, AMERICAN EXPRESS, and DISCOVER.

Diagram 12 Subscriber Login Screen

Enter a user name and password and click **Enter**. Depending on the settings in the ZyAIR, either the specified web page or an advertisement web page displays. A **Time Window** screen also displays showing the amount of time remaining on the account for Internet access.

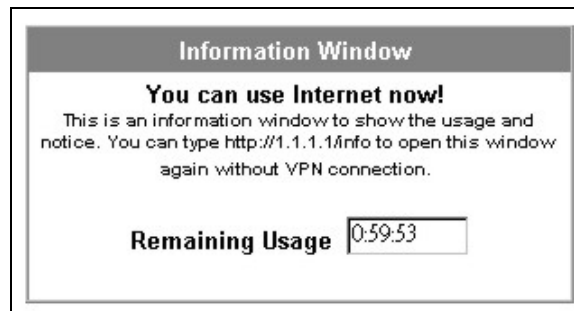

The image shows an "Information Window" with the following text: "You can use Internet now! This is an information window to show the usage and notice. You can type <http://1.1.1.1/info> to open this window again without VPN connection." Below this text, it displays "Remaining Usage" with a digital timer showing "0:59:53".

Diagram 13 Subscriber Login: Time Windows

Appendix I.

Power and Cable Specifications

Power Adaptor

The ZyAIR uses an external power adaptor with the following specifications.

- Input: 100-240 VAC, 50/60 Hz, 0.4 A
- Output: 5 V, 2 A

Power over Ethernet

The ZyAIR is compatible with IEEE 802.3af so it can receive power through an Ethernet cable. Use standard 8-wire CAT 5 10/100 BaseT Ethernet cable to connect an IEEE 802.3af compatible power injector to the WAN port.

The ZyAIR receives DC power through the unused twisted-wires (pairs 4/5 and 7/8) of the Ethernet cable.

RJ-45 Ethernet Port

The following table describes the types of network cable used for the different connection speeds.



Make sure the Ethernet cable length between connections does not exceed 100 meters (328 feet).

Chart 14 Network Cable Types

SPEED	NETWORK CABLE TYPE
10 Base-TX	100Ω 2-pair UTP/STP Category 3, 4 or 5
100 Base-TX	100Ω 2-pair UTP/STP Category 5

The WAN Port

The following table describes the Ethernet cable pin assignments for the WAN port.

Chart 15 WAN Port Cable Pin Assignments

	PIN NO	RJ-45 SIGNAL ASSIGNMENT	DESIGNATION
	1	Output Transmit Data +	TD+
	2	Output Transmit Data -	TD-
	3	Input Transmit Data +	RD+
	4	Unused	N/U
	5	Unused	N/U
	6	Input Transmit Data -	RD-
	7	Unused	N/U
	8	Unused	N/U

Make sure that the Ethernet cable connection between the ZyAIR and the hub or router conforms to the following pin assignments.

Chart 16 WAN Port Cable Pin Assignments

ETHERNET DEVICE (SWITCH/HUB/ROUTER ETC.)		ZYAIR	
1	RD+	1	TD+
2	RD-	2	TD-
3	TD+	3	RD+
6	TD-	6	RD-

The LAN Port

The following table describes the Ethernet cable pin assignments for the LAN port.

Chart 17 LAN Port Cable Pin Assignments

PIN NO	RJ-45 SIGNAL ASSIGNMENT	DESIGNATION
1	Input Transmit Data +	RD+
2	Input Transmit Data -	RD-
3	Output Transmit Data +	TD+
4	Unused	N/U
5	Unused	N/U
6	Output Transmit Data -	TD-
7	Unused	N/U
8	Unused	N/U

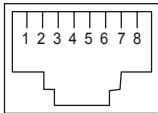

Make sure that the Ethernet cable connection between the ZyAIR and a computer or switch uplink port conforms to the following pin assignments.

Chart 18 LAN Port Cable Pin Assignments

ETHERNET DEVICE (COMPUTER/ UPLINK PORT)		ZYAIR	
1	TD+	1	RD+
2	TD-	2	RD-
3	RD+	3	TD+
6	RD-	6	TD-

The PRINTER Port

The following table describes the printer cable pin assignments that the ZyAIR's **PRINTER** port uses with an exclusive printer.

Chart 19 Device Port Cable Pin Assignments

ZYAIR DB9		EXCLUSIVE PRINTER RJ-11
2	—	2
3	—	3
7	—	4
5	—	5

Appendix J.

Report Printing Using the SP-200

This appendix shows you how to print reports using the SP-200. See the SP-200 User's Guide for details on how to set up the SP-200.

Reports Overview

The SP-200 allows you to print status reports about the subscriber accounts and general ZyAIR system information. Simply press a key combination on the SP-200 to print a report instantly without accessing the web configurator.

The following lists the reports that you can print using the SP-200.

- Daily account summary
- Monthly account summary
- System status
- Network statistics

Key Combinations

The following table lists the key combination to print each report.



You must press the key combination on the SP-200 within five seconds to print.

Chart 20 Report Printing Key Combinations

REPORT TYPE	KEY COMBINATION
Daily Account Summary	A B C A A
Monthly Account Summary	A B C B B
System Status	A B C C C
Network Statistics	A B C A B

The following sections describe each report printout in detail.

Daily Account Summary

The daily account report lists the accounts printed during the current day, the current day's total number of accounts and the total charge. It covers the accounts that have been printed during the current day starting from midnight (not the past 24 hours). For example, if you press the daily account key combination on 2005/8/1 at 20:00:00, the daily account report includes the accounts created on 2005/8/1 between 00:00:01 and 19:59:59.

Key combination: A B C A A

The following figure shows an example. “B” stands for the button that was pressed to generate the account. “UN” stands for the units of Internet access that were purchased.

Daily Account				

2005/8/1				

S/N	Username	B	UN	Price

000002	p2m6pf52	1	1	1.00
000003	s4pcms28	1	2	2.00

TOTAL ACCOUNTS: 2				
TOTAL PRICE: \$ 3.00				

2005/8/1 20:00:11				
---End---				

Diagram 14 Daily Account Example

Monthly Account Summary

The monthly account report lists the accounts printed during the current month, the current month’s total number of accounts and the total charge. It covers the accounts that have been printed during the current month starting from midnight of the first day of the current month (not the past one month period). For example, if you press the monthly account key combination on 2005/8/17 at 20:00:00, the monthly account report includes the accounts created from 2005/8/1 at 00:00:01 to 2005/8/17 at 19:59:59.

Key combination: A B C B B

The following figure shows an example. “B” stands for the button that was pressed to generate the account. “UN” stands for the units of Internet access that were purchased.

Monthly Account				

2005/8/1				

S/N	Username	B	UN	Price

000002	p2m6pf52	1	1	1.00
000003	s4pcms28	1	2	2.00
000004	7ufm7z22	2	1	2.00
000005	qm5fxn95	3	2	6.00

TOTAL ACCOUNTS: 4				
TOTAL PRICE: \$ 11.00				

2005/8/1 20:00:11				
---End---				

Diagram 15 Monthly Account Example

Account Report Notes

The daily or monthly account report holds up to 2000 entries. If there are more than 2000 accounts created in the same month or same day, the account report’s calculations only include the latest 2000.

For example, if 2030 accounts (each priced at \$1) have been created from 2005/7/1 00:00:00 to 2005/7/31 19:59:59, the monthly account report includes the latest 2000 accounts, so the total would be \$2,000 instead of \$2,030.

Use the **SYSTEM STATUS, ACCOUNT LOG** screen to see the accounts generated on another day or month (up to 2000 entries total).

System Status

This report shows the current system information such as the host name and WAN IP address.

Key combination: A B C C C

The following figure shows an example.

```

System Status
-----
ITEM DESCRIPTION
-----
WAST ESTABLISHED
WSTA Success
SYST 02D:02H:42M:46S
-----
HOST MyDevice
FRMW v1.00 (ZB.2) CO
WFRM
BTRM 1.01
LOCA
WAMA 00-90-0E-00-4A-29
LAMA 00-90-0E-00-4A-28
WATP DHCP
WAIP 172.21.2.67
WASM 255.255.0.0
WAGW 172.21.0.254
PDNS 172.20.0.63
SDNS 172.20.0.27
DHCP DHCP SERVER
DHSP 10.59.1.2
DHEP 10.59.1.254
DHLT 1440
EMAIL /PORT25
-----
2004/10/28 11:24:42
---End---

```

Diagram 16 System Status Example

The following table describes the labels in this report.

Chart 21 System Status

LABEL	DESCRIPTION
WAST	This field displays the WAN connection status.
WSTA	This field displays the status of the ZyAIR's wireless LAN.
SYST	This field displays the time since the system was last restarted.
HOST	This field displays the description name of the ZyAIR for identification purposes.
FRMW	This field displays the version of the firmware on the ZyAIR.
WFRM	This field displays the version of the (internal) wireless adapter firmware on the ZyAIR.

Chart 21 System Status

BTRM	This field displays the version of the bootrom.
WAMA	This field displays the MAC address of the ZyAIR on the WAN.
LAMA	This field displays the MAC address of the ZyAIR on the LAN.
WATP	This field displays the mode of the WAN port.
WAIP	This field displays the IP address of the WAN port on the ZyAIR.
WASM	This field displays the subnet mask of the WAN port on the ZyAIR.
WAGW	This field displays the IP address of the default gateway of the WAN port on the ZyAIR.
PDNS	This field displays the IP address of the primary DNS server.
SDNS	This field displays the IP address of the secondary DNS server.
DHCP	This field displays the DHCP mode (DHCP Server , Relay or DHCP Disable) on the LAN.
DHSP	If the DHCP field is DHCP Server , this field displays the first of the continuous addresses in the IP address pool. If the DHCP field is DHCP Relay , this field displays the DHCP server IP address.
DHEP	This field is visible when the DHCP is DHCP Server . This field displays the end of the continuous addresses in the IP address pool.
DHLT	This field is visible when the DHCP is DHCP Server . This field displays the time (in minutes) a DHCP client is allowed to use an assigned IP address.
EMAIL	The field displays e-mail server port number.
SSID	This field displays the ZyAIR's Extended Service Set IDentity.
WCHA	This field displays the channel that the ZyAIR is using.
WSEC	This field displays whether the ZyAIR's wireless security is turned on or off.

Network Statistics

This report shows the network statistics on the ZyAIR.

Key combination: A B C A B

The following figure shows an example.

```

Network
-----
ITEM DESCRIPTION
-----
WAST ESTABLISHED
WSTA Success
SYST 02D:02H:42M:46S
-----
WATD 37
WARD 4816
WATE 0
WARE 0
LATD 1768
LARD 4616
LATE 0
LARE 0
-----
2004/10/28 15:24:42
---End---

```

Diagram 17 Network Statistics Example

The following table describes the labels in this report.

Chart 22 Network Statistics

LABEL	DESCRIPTION
WAST	This field displays the WAN connection status.
WSTA	This field displays the wireless LAN status.
SYST	This field displays the time since the system was last restarted.
WATD	This field displays the number of packets transmitted on the WAN.
WARD	This field displays the number of packets received on the WAN.
WATE	This field displays the number of error packets transmitted on the WAN.
WARE	This field displays the number of error packets received on the WAN.
LATD	This field displays the number of packets transmitted on the LAN.
LARD	This field displays the number of packets received on the LAN.
LATE	This field displays the number of error packets transmitted on the LAN.
LARE	This field displays the number of error packets received on the LAN.

Index

2	
2.4 GHz.....	21-3
A	
Access Control.....	1-3
Account Activated	18-4
Account Created	18-4
Account Deletion	8-3
Account Generator.....	1-4
Account Information.....	11-21
Account Log	22-4
Account Manager Account	2-6
Account Printout.....	11-11
Account Printout Preview.....	11-14
Account Usage Time	7-3
Accounting.....	1-2, 8-1
Accounts	
Creating.....	8-5
Accumulation.....	6-3, 7-3, 11-13
Accumulation Accounting.....	7-1
Address Resolution Protocol (ARP).....	3-2
Ad-hoc Configuration.....	N
Administrator Account	2-6
Administrator Idle-Timeout.....	4-8
Advanced Subscriber Login Screen.....	11-5
Advertisement Links.....	15-1
Advertising Links	1-3
Antenna	
Omni-directional.....	Q
Types.....	Q
Antenna Gain.....	Q
Antennas	Q, 1-4
Any IP.....	1-1
Note	3-2, 3-5
Applications	1-4
Article	11-6
Article Background Color.....	11-6
Article Text Color	11-6
Authentication.....	5-1
Authentication Method	21-9
Authorization Code.....	11-19
Authorize.net	
Email Additional Information.....	9-2
Merchant Name	9-2
Merchant Transaction Key.....	9-2
Payment Gateway	9-2
Authorize.net.....	9-2
Merchant ID.....	9-2
Auto-negotiation	1-4
B	
Background Color.....	11-3
Bandwidth.....	20-1
Bandwidth Management.....	20-2
Maximum Downstream	20-2
Maximum Upstream	20-2
Basic Service Set.....	N
Beacon Interval	21-8
Billing	7-1
Billing Log.....	18-6
Billing Method	11-13
Billing Profile.....	11-13
Bluetooth.....	21-3
Boot Code Upgrade.....	23-8
Bootrom Version.....	22-3
BSS	<i>See</i> Basic Service Set
Built-in Authentication	5-1
Button Presses	8-4

C	
Cable	
Pin Assignments	EE
Cancel Button.....	11-3
CCK	<i>See</i> Complementary Code Keying
Changing System Password.....	2-7
Channel	21-3, 22-4
Charge.....	7-3
Charge by Levels	8-1, 8-4
Clear to Send.....	21-4
Code.....	11-4
Comments	11-6
Complementary Code Keying.....	21-2
Computer's IP Address	A
Conditions.....	8-4
Configuration and Firmware Files	
Filename Convention.....	23-1
Configuration File	
Backup.....	23-1, 23-3
Restore.....	23-4, 23-5
Connect on Demand.....	4-5, 4-6
Connection ID/Name	4-6
Connector Type.....	R
Copyright	ii, 11-3
Coverage	21-3
Credit Card.....	9-1, 11-16
Credit Card Code	11-19
Credit Card Fail.....	11-22
Credit Card Icons	9-2
Credit Card Number.....	11-19
Credit Card Service.....	7-2
Currency.....	7-3
Current User Information Backup.....	5-2
Current Users	22-6
Customer ID.....	11-19
Customer Support	vii
Customization	11-1
D	
Data encryption	21-4
Data Rates	21-2
Daylight Saving Time	3-4
DBPSK.....	<i>See</i> Differential Binary Phase Shift Keyed
Decimal Places	7-3
Default Gateway.....	2-6
Default IP Gateway	22-3
Default LAN IP address	4-1
Device IP Address.....	17-2
Device Name.....	17-2
Device Server Port	17-2
DHCP	1-2, 22-3
DHCP client	4-1
DHCP Client	4-5
DHCP Client Table	22-6
DHCP Pool Size	4-8
DHCP Server.....	4-8
DHCP Server IP Address	4-8
Differential Binary Phase Shift Keyed.....	21-2
Differential Quadrature Phase Shift Keying	21-2
Direct Sequence Spread Spectrum	M
Discount Price Plan	8-1, 8-4
Distribution System.....	N
DNS.....	2-6, 22-3
DNS Fake IP Reply.....	3-5
DNS Proxy	1-2
DNS Server	4-5, 4-8
Domain Name	2-5, 3-1, 3-4, 22-3
Domain Name System.....	4-2
DQPSK.....	<i>See</i> Differential Quadrature Phase Shift Keying

DS	<i>See</i> Distribution System	Filename Conventions.....	23-1
DSSS....	<i>See</i> Direct Sequence Spread Spectrum	Filtering.....	13-1
Dynamic DNS.....	16-1	Firmware	1-3
Dynamic Host Configuration Protocol	4-1	Firmware Upgrade	23-6
DYNDNS Wildcard.....	16-1	Scheduled.....	23-9
E		Firmware Version	2-5, 22-3
Email Button.....	11-21	Footnote	11-3
E-mail Forwarding.....	1-2	Fragmentation Threshold.....	21-5, 21-8
E-mail Redirection.....	22-4	Framed Subscriber Login Screen	11-7
Email Server	18-2	Frequency.....	Q
E-mail Server Redirect	4-8	Frequency-Hopping Spread Spectrum	M
Enable Credit Card Service	7-2	G	
Encapsulation		Gateway IP Address.....	4-5
PPP over Ethernet	S	Generic Interface Specification.....	6-4
Encryption	2-6, 22-4	H	
Ending.....	11-13	Host IDs	W
Enter Button.....	11-3	Host Name	3-4, 22-3
ESS ... <i>See</i> Extended Service Set. <i>See</i> Extended Service Set		I	
ESSID	2-6, 11-13, 21-2, 22-4	IANA.....	4-1, 4-2
Ethernet Cable Length Limit	EE	IBSS	<i>See</i> Independent Basic Service Set
Ethernet Cable Types.....	EE	Idle Time Out.....	6-3, 7-3
Exclusive Printer.....	1-4, 8-7	IEEE 802.11	M
Expiration	8-3	IEEE 802.11b.....	1-3
Expiration Time.....	11-13, 11-21	Data Rates.....	21-2
Extended Service Set	N, 21-2	Modulation.....	21-2
Extended Service Set IDentification.....	21-7	IEEE 802.11g.....	1-3, 21-2
F		Data Rates.....	21-3
Factory Ethernet Defaults	4-1	Modulation.....	21-3
Factory-Defaults	2-9	IEEE 802.1Q Tagged VLAN	1-1
FCC.....	iii	Independent Basic Service Set.....	N, 21-1
Features.....	1-1	Information Windows	11-9
FHSS.....	<i>See</i> Frequency-Hopping Spread Spectrum	Infrastructure Configuration	N
		Inside Server	17-3
		Internet Assigned Numbers Authority	<i>See</i> IANA

IP Address.....	4-1	Location Name	2-5
LAN.....	4-4, 22-3	Log Formats	18-4
WAN	4-5, 22-3	Logged-in Users	18-4
IP Address Assignment.....	4-1	Login Accounts	
IP Address Assignment Conflicts	K	Types	2-6
IP Addresses		Login Name.....	16-3
Private.....	4-2	Login Page Preview	11-3
IP Addressing.....	W	Logo	11-3, 11-8, 11-13
IP Classes	W		
IP Plug and Play.....	3-5	M	
IP Pool Starting Address.....	4-8	MAC Address	
iPass	6-4	Of LAN Device	17-2
IPASS GIS	6-4	Manual Entry.....	21-7
iPnP	3-1, 3-5	Manual Firmware Upgrade	
How it works	3-2	Using TFTP.....	23-7
		Modulation	21-2, 21-3
K		Multicast Pass Through.....	3-5
Keep Alive	4-5, 4-6	My IP Address.....	4-5
Keypad.....	10-1	My Subnet Mask	4-5
L		N	
LAN		NAT.....	1-2, 3-4, 4-3
IP Address	2-6, 4-4, 22-3	NAT (Network Address Translation - NAT, RFC 1631).....	17-1
MAC Address.....	2-6, 22-3	Navigating	2-2
Subnet Mask.....	2-6, 4-4	Network Cable Types	
LAN Device	17-1	100Mbps.....	EE
Accessing.....	22-9	10Mbps.....	EE
Detecting Time	17-2	Notice Message	11-10
Management	17-1, 17-3	Notification Message.....	11-19, 11-21
Port Mapping.....	17-1		
LAN Devices	22-9	O	
LAN Devices Alarm	18-6	OFDM	<i>See</i> Orthogonal Frequency Division Multiplexing
LAN Devices Information	18-6	Open System	21-9
LAN Subnet Mask	22-3	Orthogonal Frequency Division Multiplexing	21-3
Layer 2 Isolation Security	3-5		
Lease Time.....	4-8		
Level	8-4		
Limiting User Sessions	3-5		
Local Content.....	1-3		
Local Subscriber Database.....	1-2		

P	R
Page Background 11-6	Radiation Pattern..... Q
Pass Through 12-1	RADIUS.....6-1
Pass Through List 12-3	Redirect Login Page URL..... 5-2, 11-4
Password 11-3	Redirect Subscriber Login Screen..... 11-4
Payment Information 11-19	Related Documentation..... xxi
Ping Command 25-1	Replenish.....8-3
Point-to-Point Tunneling Protocol..... 4-3	Request To Send21-4
Port Mapping 17-1	Reset Button..... 1-4, 2-9
Portal Page..... 15-1	Restart26-1
Post-Paid 7-3	Restarting the ZyAIR2-11
Post-Paid Billing..... 10-2, 10-4	Restoring Factory-Defaults2-9
PPP MTU..... 4-3	Restricted Destination List..... 13-2
PPP MTU Setting 4-5	Reverse SMA connectors..... 1-4
PPPoE 1-2, 4-2, 4-3, 4-5	RF signals..... M
PPPoE Password..... 4-5	RTS /CTS Threshold.....21-4
PPPoE Username 4-5	RTS Threshold21-8
PPTP U, 1-2, 4-3, 4-5	S
PPTP Password..... 4-5	Scheduled Firmware Upgrade.....23-9
PPTP Server IP Address 4-5	Secure Administrator IP Addresses3-5
PPTP Username 4-5	Secure Socket Layer.....24-1
Preamble Type..... 21-8	Server Configuration.....4-6
Pre-Paid 7-2	Server Port17-1
Pre-Paid Billing 10-2	Service..... vi
Previewing Printouts..... 11-13	Service Name4-5
Price 11-13	Service Selection Message..... 11-19
Print out Time 11-13	Service Set21-7
Printout 8-3	Session Limits3-5
Printout Previews..... 11-13	Session List22-7
Private IP Addresses 4-2	Session Trace 19-1
Purchase Unit..... 11-13	Share LAN Resource 14-1
Purchase Unit Message..... 11-19	Shared Key21-9
Q	SMTP Port 4-9, 18-2
Quick Start Guide xxi	Specifying an Inside Server 17-3

SSL.....	24-1	System Name	3-1
SSL Certificate.....	3-5, 22-4	System Time.....	2-5
SSL Certificate Download	24-6	System Up Time.....	2-5
SSL Login Page Security	5-2	System/Host Name.....	2-5
SSL Secure Login	1-1		
SSL Security	4-8	T	
SSL Security Certificate	24-2	Tax.....	11-13
SSL Security for Subscriber Logins.....	24-6	Tax Percentage	7-3
Standard Subscriber Login Screen.....	11-2	TCP MSS	4-3
Statement Printer.....	1-4	TCP MSS Setting	4-5
Static IP	4-5	Three-Buttons Printer.....	8-3
Submit Button	11-21	Time to Finish	6-3, 7-3
Subnet Mask.....	4-1	Time-to-finish Accounting.....	7-1
LAN.....	4-4, 22-3	Title	11-3, 11-13
WAN	4-5, 22-3	Total	11-13
Subnet Masks	X	Troubleshooting	27-1
Subnetting	X	Account Generator.....	27-3
Subscriber Accounts	8-1	Internet Access	27-2
Subscriber Information Window.....	11-9	Internet Browser Display.....	27-2
Subscriber Login.....	CC	LAN LEDs	27-1
Subscriber Login Screen		Power LED	27-1
Advanced.....	11-5	WAN LEDs	27-1
Framed.....	11-7	Web Configurator.....	27-2
Redirect.....	11-4		
Standard.....	11-2	U	
Subtitle	11-3, 11-13	Unit Price	8-4
Super Subscriber Account.....	2-7	Usage Time	11-13, 11-21
Supervisor Account.....	2-6	User Agreement.....	5-2, 18-5
Supporting Disk	xxi	User Session Limited	3-5
Syslog.....	1-3, 18-1	Username.....	11-3
Syslog Log Settings	18-2	Using LEDs To Diagnose Problems	27-1
Syslog Server	18-1		
System Boot Notice	18-4	V	
System Information.....	18-4, 22-1	Virtual Port.....	17-1, 17-2
System Login Accounts		VPN Pass Through.....	1-1
Account manager.....	2-6		
Administrator.....	2-6	W	
System Manager Activity Information	18-4	Walled Garden	1-3, 15-2
		Walled Garden Login.....	15-3

WAN	
IP Address.....	2-6, 4-5, 22-3
MAC Address.....	2-6, 4-5, 22-3
Subnet Mask.....	2-6, 4-5, 22-3
WAN Port Mode.....	4-5, 22-3
WAN Status.....	2-6
WAN Type.....	2-6
Warning/Alarm Message.....	11-10
Watchdog.....	1-3
Web Configurator.....	2-1
Accessing.....	2-1
Screens Overview.....	2-3
Supported Browsers.....	2-1
Web Server.....	4-7
Web Server Port.....	4-7
Web-based Account Generator Panel.....	8-3
Welcome Slogan.....	11-6
WEP.....	1-1, 21-3, 21-7, 22-4
WEP Encryption.....	11-13
Wi-Fi based Wireless Internet Service Provider Roaming.....	6-4
Wireless.....	22-3
Wireless Association Information.....	18-4
Wireless Channel.....	2-6
Wireless Firmware Version.....	22-3
Wireless LAN.....	M, 21-1
Benefits.....	M
Coverage.....	21-3
Wireless Service.....	2-6
Wireless Standards.....	21-2
WISPr.....	6-4
Wizard Setup.....	2-2, 3-1
WLAN.....	21-1. <i>See</i> Wireless LAN
WorldPay.....	9-2
Currency Code.....	9-2
Installation ID.....	9-2
Payment Gateway.....	9-2
Test Mode.....	9-2
WPA.....	1-1, 21-3, 21-7, 22-4
WPA Encryption.....	11-13
Z	
ZyXEL Limited Warranty	
Note.....	vi

