

ZyAIR G-5100 Support Notes

V3.50(HV.0)b3 / 11/10/2004

FAQ

- [ZyNOS FAQ](#)
- [Product FAQ](#)
- [Wireless FAQ](#)

Application Notes

- [Infrastructure Mode](#)
- [Wireless MAC Address Filtering](#)
- [WEP Configurations](#)
- [Roaming](#)
- [Site Survey](#)
- [Repeater mode](#)
- [AP + Bridge mode](#)
- [802.1x/WPA](#)

CI Command List

Trouble Shooting

All contents copyright (c) 2004 ZyXEL Communications Corporation.

ZyNOS FAQ

1. [What is ZyNOS?](#)
 2. [How do I access the embeded web configurator?](#)
 3. [What is the default username and password? Moreover, how do I change it?](#)
 4. [How do I upload the ZyNOS firmware code via embedded web configurator?](#)
 5. [How do I upgrade/backup the ZyNOS firmware by using TFTP client program via LAN?](#)
 6. [How do I upgrade/backup the ZyNOS firmware by using FTP client program via LAN?](#)
 7. [How do I upload or backup ROMFILE via web configurator?](#)
 8. [How do I backup/restore configurations by using TFTP client program via LAN?](#)
 9. [How do I backup/restore configurations by using FTP client program via LAN?](#)
-

1. What is ZyNOS?

ZyNOS is ZyXEL's proprietary Network Operating System. It is the platform on all ZyXEL device that delivers network services and applications. It is designed in a modular fashion so it is easy for developers to add new features. New ZyNOS software upgrades can be easily downloaded from our FTP sites as they become available.

2. How do I access the embeded web configurator?

The Web configurator is configuration interface via user's web browser, which can be access by typing in the IP address of the ZyAIR G-5100 in users web browser. To access the ZyAIR G-5100's web configurator via web browser, the configuration PC must be in the same IP segment of ZyAIR G-5100 and ZyAIR G-5100 must be reachable to the configuration station.

3. What is the default username and password? Moreover, how do I change it?

The default username is "admin" and can not be changed, the default password is 1234. You can change the password once you enter the web configuration menu under "ADVANCED" -> "SYSTEM" and press the Password tab. At the password screen type in the old password and the new password and retype to confirm than press "Apply" button to save the change.

4. How do I upload the ZyNOS firmware code via embeded web configurator?

The procedure for uploading ZyNOS via embeded web configurator is as follows.

- a. Log on into the web configurator
- b. Press "MAINTENANCE" from the left menu.
- c. Press "F/W Upload" from the left menu.
- d. Press "browse" button and point to the directory where the firmware you want to upload is kept and press "Upload" button
- e. It will prompt you the firmware is upload successful and ZyAIR G-5100 will reboot.

5. How do I upgrade/backup the ZyNOS firmware by using TFTP client program via LAN?

The ZyAIR G-5100 allows you to transfer the firmware from/to ZyAIR G-5100 by using TFTP program via LAN. The procedure for uploading ZyNOS via TFTP, FTP is as follows.

- a. Use the TELNET client program in your PC to login to your Prestige.
- b. Enter CI command '**sys stdio 0**' in menu 24.8 to disable console idle timeout
- c. To upgrade firmware, use TFTP client program to put firmware in file '**ras**' in the ZyAIR G-5100. After data transfer is finished, the Prestige will program the upgraded firmware into FLASH ROM and reboot itself.
- d. To backup your firmware, use the TFTP client program to get file '**ras**' from the ZyAIR G-5100.

6. How do I upgrade/backup the ZyNOS firmware by using FTP client program via LAN?

The ZyAIR G-5100 allows you to transfer the firmware from/to ZyAIR G-5100 by using FTP program via LAN. The procedure for uploading ZyNOS via FTP is as follows.

- a. Use the TELNET client program in your PC to login to your Prestige.
- b. To upgrade firmware, use FTP client program to put firmware in file '**ras**' in the ZyAIR G-5100. After data transfer is finished, the Prestige will program the upgraded firmware into FLASH ROM and reboot itself.
- c. To backup your firmware, use the FTP client program to get file '**ras**' from the ZyAIR G-5100.

7. How do I upload or backup ROMFILE via web configurator?

In some situations, you may need to upload the ROMFILE, restore to previous saved configuration, or the need of resetting SMT to factory default.

The procedure for uploading ROMFILE via the web configurator is as follows.

- a. Log on into the Web Configurator
- b. Press "MAINTENANCE" from the left menu.

- c. Press "Configuration" from the left menu.
- d. Press "Restore" tab and press browse button point to the directory where the romfile you want to upload is stored.
- e. Press "Upload" button.

The procedure for backup ROMFILE via the Web Configurator is as follow

- a. Log on into the Web Configurator
- b. Press "MAINTENANCE" from the left menu.
- c. Press "Configuration" from the left menu.
- d. Press "Backup" tab and press "Backup" button, a pop up windows will ask you where to store the back up ROMFILE.
- e. Press "Save file" and browse to where you want the file be save.
- f. Press "Save" button.

8. How do I backup/restore configurations by using TFTP client program via LAN?

- a. Use the TELNET client program in your PC to login to your ZyAIR G-5100.
- b. Enter CI command '**sys studio 0**' in menu 24.8 to disable console idle timeout.
- c. To backup the configurations, use TFTP client program to get file '**rom-0**' from the Prestige.
- d. To restore the configurations, use the TFTP client program to put your configuration in file **ROM-0** in the ZyAIR G-5100.

9. How do I backup/restore configurations by using FTP client program via LAN?

- a. Use the TELNET client program in your PC to login to your ZyAIR G-5100.
- b. To backup the configurations, use FTPclient program to get file '**rom-0**' from the Prestige.
- c. To restore the configurations, use the FTP client program to put your configuration in file **ROM-0** in the ZyAIR G-5100.

All contents copyright © 2003 ZyXEL Communications Corporation.

Product FAQ

General FAQ

1. [What is the ZyAIR G-5100 Wireless Access Point?](#)
2. [Which Applications can I use with the ZyAIR G-5100 ?](#)
3. [What is the coverage range of ZyAIR G-5100?](#)
4. [What is the range coverage of B-100/B-200/B-300/B-400?](#)
5. [What can I do if I lost the password for my ZyAIR G-5100 and can't access it's configuration any more?](#)
6. [How do I used the reset button, more over what field of parameter will be reset by reset button?](#)
7. [Why can't I configure B-100/B-200/B-300 with the supplied utility in Windows XP](#)
8. [What is the default user name and password to login the ZyAIR G-5100 via the browser?](#)
9. [How can I manage the ZyAIR G-5100 ?](#)
10. [What network interface does the ZyAIR G-5100 support?](#)
11. [What is the maximum number of wireless client can associated with ZyAIR G-5100 simultaneously?](#)

Advanced FAQ

1. [What is the default antenna type and gain on ZyAIR G-5100?](#)
2. [Can I change the antenna on ZyAIR G-5100?](#)
3. [What are the connector type required on the replacement antenna?](#)
4. [What is the RF power output of ZyAIR G-5100?](#)
5. [What wireless security mechanism are supported by ZyAIR G-5100?](#)
6. [What is the difference between Open System and Shared Key of Authentication Type?](#)
7. [What authentication type does ZyAIR G-5100 support?](#)
8. [Why is the supplied utility for B-100/B-200/B-300 keep on prompting "Invalid WEP key length" when I try to save my WEP configuration and I am sure the configuration is correct?](#)
9. [I have problem associated with ZyAIR G-5100 with Symol wireless PcMCIA card when WEP is enabled, why?](#)
10. [What are 802.1x authentication type and which authentication type does ZyAIR G-5100 802.1x embeded server support.](#)
11. [How does the ZyAIR G-5100 support TFTP and FTP?](#)
12. [Which 802.1x authentication software client can ZyAIR G-5100 work with?](#)

1. What is the ZyAIR G-5100 Wireless Access Point?

The ZyAIR G-5100 is an outdoor wireless access point solution complete with everything needed for providing high speed wireless capability to your existing wired network. The ZyAIR G-5100 is equipped with one auto-MDI/MDIX Ethernet LAN port and two 802.11g Wireless LAN interfaces. It is the simplest and affordable solution for adding wireless mobile capability to your existing wired Ethernet network. The ZyAIR G-5100 is equipped with PoE (Power over Ethernet). This feature allows increased flexibility in the locating for your ZyAIR G-5100.

Virtually all-popular applications over Internet, such as Web, E-Mail, FTP, Telnet, Gopher, are supported. The ZyAIR G-5100 is designed for SOHO, branch offices, workgroups, and educational users.

2. Which Applications can I use with the ZyAIR G-5100 ?

ZyAIR G-5100 is bridge between wired and wireless network, since bridge is a layer 2 device it can carry all the upper layer protocol in other words it is transparent to all applications.

You can use ZyAIR G-5100 to add wireless capability to your existing wired network. Due to ZyAIR G-5100 is an outdoor access point, it is suitable to be deployed in campus, business building, village, rail stations, etc. ZyAIR G-5100 can be used in Browse the World Wide Web (WWW), send and receive individual e-mail, and download software where you can do task you can do with wired network generally can also be done on wireless network via ZyAIR G-5100 wireless access point.

3. What is the coverage range of ZyAIR G-5100?

The coverage range typically is 500m~1000m outdoor. The actual range may very depends on environment, as to obstacles and walls, RF interference, etc in the environment.

4. What is the range coverage of B-100/B-101/B-200/B-220/B-300/B-400/G-100 client adapter?

The coverage range typically is 50m~80m indoor, 150m~300m outdoor. The actual range may very depends on environment, as to obstacles and walls, RF interference, etc in the environment.

5. What can I do if I lost the password for my ZyAIR G-5100 and can't access it's configuration any more?

If you have lost the password there is no way to gain access to the device except to reset the device by pressing the reset button located by the power jack.

6. How do I used the reset button? More over what field of parameter will be reset by reset button?

You can used a sharp pointed object insert it into the little reset hole beside the power connector.

The procedures to reset the unit is as follow

1. Used a sharp pointed object insert it into the little reset hole beside the power connector.
2. Press down the reset button and hold down for approx 10 second, the unit will be reset .

Note: When the reset button is pressed all parameters will be reset back to factory default including ESSID, password, IP address, WEP Keys.

The basic default configuration after reset is as follow.

1. IP address default: 192.168.1.2
2. Password default: 1234
3. ESSID default: Wireless
4. WEP:disabled

7. Why can't I configure B-100/B-101/B-200/B-220/B-300/B-400/G-100 client adapter with the supplied utility in Windows XP?

This is because XP uses it's default configuration for wireless adapter. You can disable it by entering Control Panel->Network and Dialup Connections->Wireless network connection->Advance and uncheck the use Windows to configure wireless configuration check box and click OK. Now you need to exit the supplied configuration utility in the Windows task bar and restart it again. Now you can use the supplied utility to configure your B-100.

8. What is the default user name and password to login the ZyAIR G-5100 via the browser?

To restrict only the administrator can configure the router, there is a login procedure prompted for asking User Name and Password. The default User Name is '**admin**' and the default password is the default SMT password, '**1234**'.

9. How can I manage the ZyAIR G-5100 ?

- Configuration via web browser to the embedded Web Configurator.
- Telnet remote management
- TFTP (Trivial File Transfer Protocol), FTP firmware upgrade and configuration backup and restore.

10. What network interface does the ZyAIR G-5100 support?

The ZyAIR G-5100 supports 1 auto MDX/MDIX 10/100M Ethernet interface to connect to your existing wired Ethernet network and 1 802.11g wireless interface to connect to the wireless stations in the coverage range..

11. What is the maximum number of wireless client can associated with ZyAIR G-5100 simultaneously?

We did not limit the number of wireless client can associated with ZyAIR G-5100 simultaneously, the suggest number are no more than 32, a good number is under 10 to ensure the performance of each wireless client.

Advanced FAQ

1. What is the default antenna type and gain on ZyAIR G-5100?

The ZyAIR G-5100 are equip with omni directional antenna with 2 dBi Gains.

2. Can I change the antenna on ZyAIR G-5100?

Yes, you can change the antenna on ZyAIR G-5100 to fit your implementation needs. To change antenna you must remove it first. You can remove the antenna by holding the outer ring of the antenna and turn it counter clock wise, and firmly remove the antenna from the ZyAIR G-5100. To install it simply reverse the removing procedure.

3. What are the connector type required on the replacement antenna?

ZyAIR G-5100 are equip with Reverse Polarity SMA jack, so it will work with any 2.4Ghz wireless antenna with Reverse Polarity SMA Plug.

4. What is the RF power output of ZyAIR G-5100?

The output power of ZyAIR G-5100 is 12dBm or 16mW from the RF module.

5. What wireless security mechanism are supported by ZyAIR G-5100?

ZyAIR G-5100 supports below security mechanisms.

1. MAC address filtering.
2. 64bit/128bit WEP (Wired Equivalent Privacy).
3. 802.1x/WPA authentication support.

6. What is the difference between Open System and Shared Key of Authentication Type?

Open System:

The default authentication service that simply announces the desire to associate with another station or access point. A station can authenticate with any other station or access point using open system authentication if the receiving station designates open system authentication.

Share Key:

The optional authentication that involves a more rigorous exchange of frames, ensuring that the requesting station is authentic. For a station to use shared key authentication, it must implement WEP.

7. What authentication type does ZyAIR G-5100 support?

ZyAIR G-5100 support null authentication when WEP is disabled as specified by IEEE 802.11b/802.11g standard, and when WEP is enabled it is using shared key authentication and data are encrypted at the same time.

8. Why is the supplied utility for B-100/B-101/B-200/B-220/B-300/G-100 keep on prompting "Invalid WEP key length" when I try to save my WEP configuration and I am sure the configuration is correct?

Please make sure all 4 set of keys are with correct and WEP key length are also correct. Do not leave any key field blank.

Note: Please make sure all 4 set of keys are consistent with the 4 set of keys configured in AP.

9. I have problem associated with ZyAIR G-5100 with Symbol wireless PCMCIA card when WEP is enabled, why?

This is because when WEP is enabled in ZyAIR G-5100 it is authenticating using Shared key authentication. Symbol PcMCIA client do not support Shared key Authentication. When configuring WEP encryption please ensure open system is selected for authentication method. If you have several wireless NIC card in your network and all are from different vendor please configure the authentication method to 'Auto'. The system will auto detect the authentication method of the station.

10. What are 802.1x authentication type and which authentication type does ZyAIR G-5100 802.1x embedded server support.

802.1x specify the following authentication type, and the ZyAIR G-5100's embedded 802.1x server only support MD5/CHAP authentication.

1. MD5/CHAP
2. One time password
3. Generic Token Card
4. TLS
5. TTLS
6. LEAP
7. PEAP

11. How does the ZyAIR G-5100 support TFTP and FTP?

In addition to the direct console port connection, the Prestige supports the uploading/download of the firmware and configuration file using TFTP (Trivial File Transfer Protocol) or FTP over LAN.

12. Which 802.1x authentication software client can ZyAIR G-5100 work with?

ZyAIR G-5100 can work with the below test 802.1x authentication software.

For embedded MD5/CHAP authentication server

1. Windows XP embedded 802.1x client (Before SP1 patch).
2. Meetinghouse AEGIS client.
3. Funk Software Odyssey client.

For external TLS authentication server (Odyssey server).

1. Windows XP embedded 802.1x client
2. Funk Software Odyssey client

For external TTLS authentication server (Odyssey server)

1. Funk Software Odyssey client.

Note: 1. XP only support MD5/CHAP and TLS before SP1 patch, after upgrade SP1, XP support only PEAT authentication.

2. When using external server ZyAIR G-5100 only act as a pass-through thus no extra setting are required.

All contents copyright © 2004 ZyXEL Communications Corporation.

Wireless FAQ

General FAQ

1. [What is a Wireless LAN ?](#)
2. [What are the main advantages of Wireless LANs ?](#)
3. [What are the disadvantages of Wireless LANs ?](#)
4. [Where can you find wireless 802.11 networks ?](#)
5. [What is an Access Point ?](#)
6. [What is IEEE 802.11 ?](#)
7. [What is IEEE 802.11b ?](#)
8. [How fast is 802.11b ?](#)
9. [What is IEEE 802.11a ?](#)
10. [What is IEEE 802.11g ?](#)
11. [Is it possible to use products from a variety of vendors ?](#)
12. [What is Wi-Fi ?](#)
13. [What types of devices use the 2.4GHz Band ?](#)
14. [Does Bluetooth interfere with wireless 802.11 LAN ?](#)
15. [Can radio signals pass through walls ?](#)
16. [What are potential factors that may cause interference among WLAN products ?](#)
17. [What's the difference between a WLAN and a WWAN ?](#)

Advanced FAQ

1. [What is Ad Hoc mode ?](#)
2. [What is Infrastructure mode ?](#)
3. [How many Access Points are required in a given area ?](#)
4. [What is Direct-Sequence Spread Spectrum Technology – \(DSSS\) ?](#)
5. [What is Frequency-hopping Spread Spectrum Technology – \(FHSS\) ?](#)
6. [Do I need the same kind of antenna on both sides of a link ?](#)
7. [Why the 2.4 Ghz Frequency range ?](#)
8. [What is Server Set ID \(SSID\) ?](#)
9. [What is an ESSID ?](#)

Security FAQ

1. [How do I secure the data across an Access Point's radio link?](#)
 2. [What is WEP ?](#)
 3. [What is the difference between 40-bit and 64-bit WEP ?](#)
 4. [What is a WEP key ?](#)
 5. [Will 128-bit WEP communicate with 64-bit WEP ?](#)
 6. [Can the SSID be encrypted ?](#)
 7. [By turning off the broadcast of SSID, can someone still sniff the SSID ?](#)
 8. [What are Insertion Attacks?](#)
 9. [What is Wireless Sniffer ?](#)
 10. [What is the difference between Open System and Shared Key of Authentication Type ?](#)
 11. [What is 802.1x ?](#)
 12. [What is the difference between force-authorized, force-unauthorized and auto?](#)
 13. [What is AAA ?](#)
 14. [What is RADIUS ?](#)
-

Basic FAQ

1. What is a Wireless LAN ?

Wireless LANs provide all the functionality of wired LANs, without the need for physical connections (wires). Data is modulated onto a radio frequency carrier and transmitted through the ether. Typical bit-rates are 11Mbps and 54Mbps, although in practice data throughput is half of this. Wireless LANs can be formed simply by equipping PC's with wireless NICs. If connectivity to a wired LAN is required an Access Point (AP) is used as a bridging device. AP's are typically located close to the centre of the wireless client population.

2. What are the advantages of Wireless LANs ?

a. Mobility:

Wireless LAN systems can provide LAN users with access to real-time information anywhere in their organization. This mobility supports productivity and service opportunities not possible with wired networks.

b. Installation Speed and Simplicity:

Installing a wireless LAN system can be fast and easy and can eliminate the need to pull cable through walls and ceilings.

c. Installation Flexibility:

Wireless technology allows the network to go where wire cannot go.

d. Reduced Cost-of-Ownership:

While the initial investment required for wireless LAN hardware can be higher than the cost of wired LAN hardware, overall installation expenses and life-cycle costs can be significantly lower. Long-term cost benefits are greatest in dynamic environments requiring frequent moves and changes.

e. Scalability:

Wireless LAN systems can be configured in a variety of topologies to meet the needs of specific applications and installations. Configurations are easily changed and range from peer-to-peer networks suitable for a small number of users to full infrastructure networks of thousands of users that enable roaming over a broad area.

3. What are the disadvantages of Wireless LANs ?

The speed of Wireless LAN is still relative slower than wired LAN. The most popular wired LAN is operated in 100Mbps, which is almost 10 times of that of Wireless LAN (10Mbps). A faster wired LAN standard (1000Mbps), which is 100 times faster, becomes popular as well. The setup cost of Wireless LAN is relative high because the equipment cost including access point and PCMCIA Wireless LAN card is higher than hubs and CAT 5 cables.

4. Where can you find wireless 802.11 networks ?

Airports, hotels, and even coffee shops like Starbucks are deploying 802.11 networks so people can wirelessly browse the Internet with their laptops. As these types of networks increase, this will create additional security risk for the remote user if not properly protected.

5. What is an Access Point ?

The AP (access point also known as a base station) is the wireless server that with an antenna and a wired Ethernet connection that broadcasts information using radio signals. AP typically act as a bridge for the clients. It can pass information to wireless LAN cards that have been installed in computers or laptops allowing those computers to connect to the campus network and the Internet without wires.

6. What is IEEE 802.11 ?

The IEEE 802.11 is a wireless LAN industry standard, and the objective of IEEE 802.11 is to make sure that different manufactures' wireless LAN devices can communicate to each other. 802.11 provides 1 or 2 Mbps transmission in the 2.4 GHz ISM band using either FHSS or DSSS.

7. What is 802.11b ?

802.11b is the first revision of 802.11 standard allowing data rates up to 11Mbps in the 2.4GHz ISM band. Also known as 802.11 High-Rate and Wi-Fi. 802.11b only uses DSSS, the maximum speed of 11Mbps has fallbacks to 5.5, 2 and 1Mbps.

8. How fast is 802.11b ?

The IEEE 802.11b standard has a nominal speed of 11 megabits per second (Mbps). However, depending on signal quality and how many other people are using the wireless ethernet through a particular Access Point, usable speed will be much less (on the order of 4 or 5 Mbps, which is still substantially faster than most dialup, cable and DSL modems).

9. What is 802.11a ?

802.11a is the second revision of 802.11 that operates in the unlicensed 5 GHz band and allows transmission rates of up to 54Mbps. 802.11a uses OFDM (orthogonal frequency division multiplexing) as opposed to FHSS or DSSS. Higher data rates are possible by combining channels. Due to higher frequency, range is less than lower frequency systems (i.e., 802.11b and 802.11g) and can increase the cost of the overall solution because a greater number of access points may be required. 802.11a is not directly compatible with 802.11b or 802.11g networks. In other words, a user equipped with an 802.11b or 802.11g radio card will not be able to interface directly to an 802.11a access point. Multi-mode NICs will solve this problem.

10. What is 802.11g ?

802.11g is an extension to 802.11b. 802.11g increases 802.11b's data rates to 54 Mbps and still utilize the the 2.4 GHz ISM. Modulation is based upon OFDM (orthogonal frequency division multiplexing) technology. An 802.11b radio card will interface directly with an 802.11g access point (and vice versa) at 11 Mbps or lower depending on range. The range at 54 Mbps is less than for 802.11b operating at 11 Mbps.

11. Is it possible to use products from a variety of vendors ?

Yes. As long as the products comply to the same IEEE 802.11 standard. The Wi-Fi logo is used to define 802.11b compatible products. Wi-Fi5 is a compatibility standard for 802.11a products running in the 5GHz band.

12. What is Wi-Fi ?

The Wi-Fi logo signifies that a product is interoperable with wireless networking equipment from other vendors. A Wi-Fi logo product has been tested and certified by the Wireless Ethernet Compatibility Alliance (WECA). The Socket Wireless LAN Card is Wi-Fi certified, and that means that it will work (interoperate) with any brand of Access Point that is also Wi-Fi certified.

13. What types of devices use the 2.4GHz Band ?

Various spread spectrum radio communication applications use the 2.4 GHz band. This includes WLAN systems (not necessarily of the type IEEE 802.11b), cordless phones, wireless medical telemetry equipment and Bluetooth™ short-range wireless applications, which include connecting printers to computers and connecting modems or hands-free kits to mobile phones.

14. Does the 802.11 interfere with Bluetooth devices ?

Any time devices are operated in the same frequency band, there is the potential for interference.

Both the 802.11b and Bluetooth devices occupy the same 2.4-to-2.483-GHz unlicensed frequency range—the same band. But a Bluetooth device would not interfere with other 802.11 devices much more than another 802.11 device would interfere. While more collisions are possible with the introduction of a Bluetooth device, they are also possible with the introduction of another 802.11 device, or a new 2.4 GHz cordless phone for that matter. But, Bluetooth devices are usually low-power, so the effects that a Bluetooth device may have on an 802.11 network, if any, aren't far-reaching.

15. Can radio signals pass through walls ?

Transmitting through a wall is possible depending upon the material used in its construction. In general, metals and substances with a high water content do not allow radio waves to pass through. Metals reflect radio waves and concrete attenuates radio waves. The amount of attenuation suffered in passing through concrete will be a function of its thickness and amount of metal re-enforcement used.

16. What are potential factors that may causes interference among WLAN products ?

Factors of interference:

1. Obstacles: walls, ceilings, furniture... etc.
2. Building Materials: metal door, aluminum studs.
3. Electrical devices: microwaves, monitors, electric motors.

Solution :

1. Minimizing the number of walls and ceilings
2. Antenna is positioned for best reception
3. Keep WLAN products away from electrical devices, eg: microwaves, monitors, electric motors,...., etc.
4. Add additional APs if necessary.

17. What's the difference between a WLAN and a WWAN ?

WLANs are generally privately owned, wireless systems that are deployed in a corporation, warehouse, hospital, or educational campus setting. Data rates are high and there are no per-packet charges for data transmission.

WWANs are generally publicly shared data networks designed to provide coverage in metropolitan areas and along traffic corridors. WWANs are owned by a service provider or carrier. Data rates are low and charges are based on usage. Specialized applications are characteristically designed around short, burst messaging.

Advanced FAQ

1. What is Ad Hoc mode ?

A wireless network consists of a number of stations without access points. Without using an access point or any connection to a wired network.

2. What is Infrastructure mode ?

Infrastructure mode implies connectivity to a wired communications infrastructure. If such connectivity is required the Access Points must be used to connected to the wired LAN backbone. Wireless clients have their configurations set for "infrastructure mode" in order to utilize access points relaying.

3. How many Access Points are required in a given area ?

This depends on the surrounding terrain, the diameter of the client population, and the number of clients. If an area is large with dispersed pockets of populations then extension points can be used for extend coverage.

4. What is Direct-Sequence Spread Spectrum Technology – (DSSS) ?

DSSS spreads its signal continuously over a wide frequency band. DSSS maps the information bearing bit-pattern at the sending station into a higher data rate bit sequence using a "chipping" code. The chipping code (also known as processing gain) introduces redundancy which allows data recovery if certain bit errors occur during transmission. The FCC rules the minimum processing gain should be 10, typical systems use processing gains of 20. IEEE 802.11b specifies the use of DSSS.

5. What is Frequency-hopping Spread Spectrum Technology – (FHSS) ?

FHSS uses a narrowband carrier which hops through a predefined sequence of several frequencies at a specific rate. This avoids problems with fixed channel narrowband noise and simple jamming. Both transmitter and receiver must have their hopping sequences synchronized to create the effect of a single "logical channel". To an unsynchronised receivers an FHSS transmission appears to be short-duration impulse noise. 802.11 may use FHSS or DSSS.

6. Do I need the same kind of antenna on both sides of a link ?

No. Provided the antenna is optimally designed for 2.4GHz or 5GHz operation. WLAN NICs often include an internal antenna which may provide sufficient reception.

7. Why the 2.4 Ghz Frequency range ?

This frequency range has been set aside by the FCC, and is generally labeled the ISM band. A few years ago Apple and several other large corporations requested that the FCC allow the development of wireless networks within this frequency range. What we have today is a protocol and system that allows for unlicensed use of radios within a prescribed power level. The ISM band is populated by Industrial, Scientific and Medical devices that are all low power devices, but can interfere with each other.

8. What is Server Set ID (SSID) ?

SSID is a configurable identification that allows clients to communicate to the appropriate base station. With proper configuration, only clients that are configured with the same SSID can communicate with base stations having the same SSID. SSID from a security point of view acts as a simple single shared password between base stations and clients.

9. What is an ESSID ?

ESSID stands for Extended Service Set Identifier and identifies the wireless LAN. The ESSID of the mobile device must match the ESSID of the AP to communicate with the AP. The ESSID is a 32-

character maximum string and is case-sensitive.

Security FAQ

1. How do I secure the data across an Access Point's radio link ?

Enable Wired Equivalency Protocol (WEP) to encrypt the payload of packets sent across a radio link.

2. What is WEP ?

Wired Equivalent Privacy. WEP is a security mechanism defined within the 802.11 standard and designed to make the security of the wireless medium equal to that of a cable (wire). WEP data encryption was designed to prevent access to the network by "intruders" and to prevent the capture of wireless LAN traffic through eavesdropping. WEP allows the administrator to define a set of respective "Keys" for each wireless network user based on a "Key String" passed through the WEP encryption algorithm. Access is denied by anyone who does not have an assigned key. WEP comes in 40/64-bit and 128-bit encryption key lengths. Note, WEP has shown to have fundamental flaws in its key generation processing.

3. What is the difference between 40-bit and 64-bit WEP ?

40 bit WEP & 64 bit WEP are the same encryption level and can interoperate. The lower level of WEP encryption uses a 40 bit (10 Hex character) as "secret key" (set by user), and a 24 bit " Initialization Vector " (not under user control) (40+24=64). Some vendors refer to this level of WEP as 40 bit, others as 64 bit.

4. What is a WEP key ?

A WEP key is a user defined string of characters used to encrypt and decrypt data.

5. A WEP key is a user defined string of characters used to encrypt and decrypt data ?

No. 128-bit WEP will not communicate with 64-bit WEP. Although 128 bit WEP also uses a 24 bit Initialization Vector, but it uses a 104 bit as secret key. Users need to use the same encryption level in order to make a connection.

6. Can the SSID be encrypted ?

WEP, the encryption standard for 802.11, only encrypts the data packets not the 802.11 management packets and the SSID is in the beacon and probe management messages. The SSID is not encrypted if WEP is turned on. The SSID goes over the air in clear text. This makes obtaining the SSID easy by sniffing 802.11 wireless traffic.

7. By turning off the broadcast of SSID, can someone still sniff the SSID ?

Many APs by default have broadcasting the SSID turned on. Sniffers typically will find the SSID in the broadcast beacon packets. Turning off the broadcast of SSID in the beacon message (a common practice) does not prevent getting the SSID; since the SSID is sent in the clear in the probe message when a client associates to an AP, a sniffer just has to wait for a valid user to associate to the network to

see the SSID.

8. What are Insertion Attacks ?

The insertion attacks are based on placing unauthorized devices on the wireless network without going through a security process and review.

9. What is Wireless Sniffer ?

An attacker can sniff and capture legitimate traffic. Many of the sniffer tools for Ethernet are based on capturing the first part of the connection session, where the data would typically include the username and password. An intruder can masquerade as that user by using this captured information. An intruder who monitors the wireless network can apply this same attack principle on the wireless.

10. What is the difference between Open System and Shared Key of Authentication Type ?

Open System:

The default authentication service that simply announces the desire to associate with another station or access point. A station can authenticate with any other station or access point using open system authentication if the receiving station designates open system authentication.

Share Key:

The optional authentication that involves a more rigorous exchange of frames, ensuring that the requesting station is authentic. For a station to use shared key authentication, it must implement WEP.

11. What is 802.1x ?

IEEE 802.1x Port-Based Network Access Control is an IEEE (Institute of Electrical and Electronics Engineers) standard, which specifies a standard mechanism for authenticating, at the link layer (Layer 2), users' access to IEEE 802 networks such as Ethernet (IEEE 802.3) and Wireless LAN (IEEE 802.11). For IEEE 802.11 WLAN, IEEE 802.1x authentication can be based on username/password or digital certificate.

12. What is the difference between force-authorized, force-unauthorized and auto ?

force-authorized—disables 802.1X and causes the port to transition to the authorized state without any authentication exchange required. The port transmits and receives normal traffic without 802.1X-based authentication of the client.

force-unauthorized—causes the port to remain in the unauthorized state, ignoring all attempts by the client to authenticate. The switch cannot provide authentication services to the client through the interface.

auto—enables 802.1X and causes the port to begin in the unauthorized state, allowing only EAPOL frames to be sent and received through the port. The authentication process begins when the link state of the port transitions from down to up, or when an EAPOL-start frame is received. The switch requests the identity of the client and begins relaying authentication messages between the client and the authentication server. Each client attempting to access the network is uniquely identified by the switch by using the client's MAC address.

13. What is AAA ?

AAA is the acronym for Authentication, Authorization, and Accounting and refers to the idea of

managing subscribers by controlling their access to the network, verifying that they are who they say they are (via login name and password or MAC address) and accounting for their network usage.

14. What is RADIUS ?

RADIUS stands for Remote Authentication Dial-In User Service. RADIUS is a standard that has been implemented into several software packages and networking devices. It allows user information to be sent to a central database running on a RADIUS Server, where it is verified. RADIUS also provides a mechanism for accounting.

All contents copyright © 2003 ZyXEL Communications Corporation.

Configuring Infrastructure mode

- [Infrastructure Introduction](#)
- [Configure wireless access point to Infrastructure mode with SMT](#)
- [Configure wireless access point to Infrastructure mode with Web configurator](#)
- [Configure wireless station to Infrastructure mode](#)

j@

- **Introduction**

What is Infrastructure mode ?

Infrastructure mode, sometimes referred to as Access Point mode, is an operating mode of an 802.11b/Wi-Fi client unit. In infrastructure mode, the client unit can associate with an 802.11b/Wi-Fi Access Point and communicate with other clients in infrastructure mode through that access point.

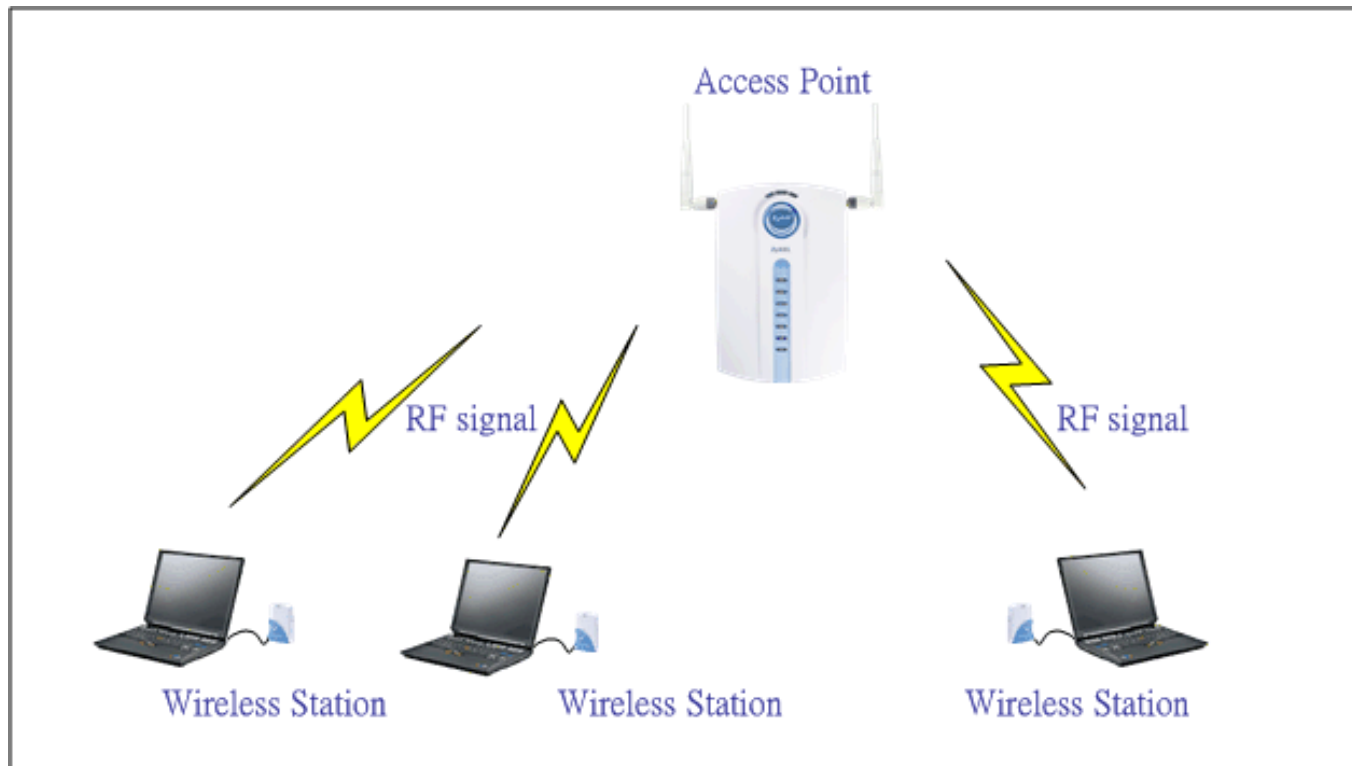

Configuration Wireless Access Point to Infrastructure mode using SMT.

To configure Infrastructure mode of your ZyAIR G-5100 wireless AP please follow the steps below.

1. From the SMT main menu, enter 3 to display Menu 3 ;V LAN Setup.
2. Enter 5 to display Menu 3.5 ;V Wireless LAN Setup.

Menu 3.5 - Wireless LAN Setup

ESSID= Wireless	Edit MAC Address Filter= No
Hide ESSID= No	Edit Roaming Configuration= No
Channel ID= CH06 2437MHz	Block Intra-BSS Traffic= Yes
RTS Threshold= 2432	Number of Associated Stations= 32
Frag. Threshold= 2432	Breathing LED= Yes
WEP Encryption= Disable	Output Power= 17dBm
Default Key= N/A	
Key1= N/A	
Key2= N/A	
Key3= N/A	
Key4= N/A	
Authen. Method= N/A	

Press ENTER to Confirm or ESC to Cancel:

3. Configure ESSID, Channel ID, WEP, Default Key and Keys as you desire.

Configuration Wireless Access Point to Infrastructure mode using Web configurator.

To configure Infrastructure mode of your ZyAIR G-5100 wireless AP please follow the steps below.

1. From the web configurator main menu, click advanced->>wireless to display Wireless LAN.

ZyXEL

WIZARD
SETUP

ADVANCED
SYSTEM
WIRELESS
IP
LOGS
VLAN

MAINTENANCE

LOGOUT

WIRELESS LAN

Wireless	MAC Filter	Roaming	802.1x/WPA	Local User Database	RADIUS
<p>Operating Mode Access Point ▾</p> <p>ESSID Wireless</p> <p><input type="checkbox"/> Hide ESSID</p> <p>Choose Channel ID Channel-01 2412MHz ▾ or Scan</p> <p>RTS/CTS Threshold 2432 (0 ~ 2432)</p> <p>Fragmentation Threshold 2432 (256 ~ 2432)</p> <p>WEP Encryption Disable ▾</p> <p>Authentication Method Auto ▾</p> <p><small>64-bit WEP: Enter 5 characters or 10 digit ("0-9", "A-F") for each Key(1-4). 128-bit WEP: Enter 13 characters or 26 digit ("0-9", "A-F") for each Key(1-4). (Select one WEP key as an active key to encrypt wireless data transmission.)</small></p> <p style="text-align: center;"><input checked="" type="radio"/> ASCII <input type="radio"/> Hex</p> <p><input checked="" type="radio"/> Key 1 <input type="text"/></p> <p><input type="radio"/> Key 2 <input type="text"/></p> <p><input type="radio"/> Key 3 <input type="text"/></p> <p><input type="radio"/> Key 4 <input type="text"/></p> <p><input checked="" type="checkbox"/> Enable Breathing LED</p> <p><input checked="" type="checkbox"/> Enable Spanning Tree Protocol (STP)</p> <p>Preamble Long ▾</p>					

802.11 Mode	Mixed
Max. Frame Burst	650 (0 ~1800)
VLAN ID	0 (1 ~255)

Apply Reset

3. Configure the desired configuration on ZyAIR G-5100.

4. Finished.

- ***Configuration Wireless Station to Infrastructure mode***

To configure Infrastructure mode on your ZyAIR B-100/B-200/B-300 wireless NIC card please follow the following steps.

1. Double click on the utility icon in your windows task bar the utility will pop up on your windows screen.
2. Select configuration tab.

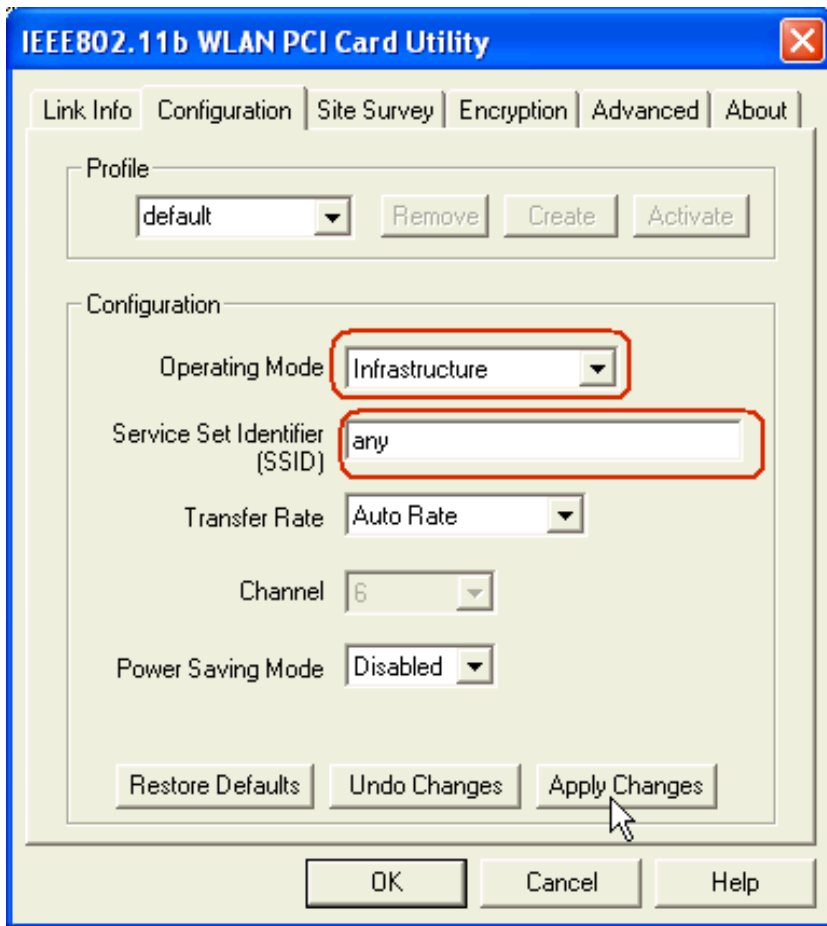

3. Select Infrastructure from the operation mode pull down menu, fill in an SSID or leave it as any if you wish to connect to any AP than press Apply Change to take effect.

4. Click on Site Survey tab, and press search all the available AP will be listed.

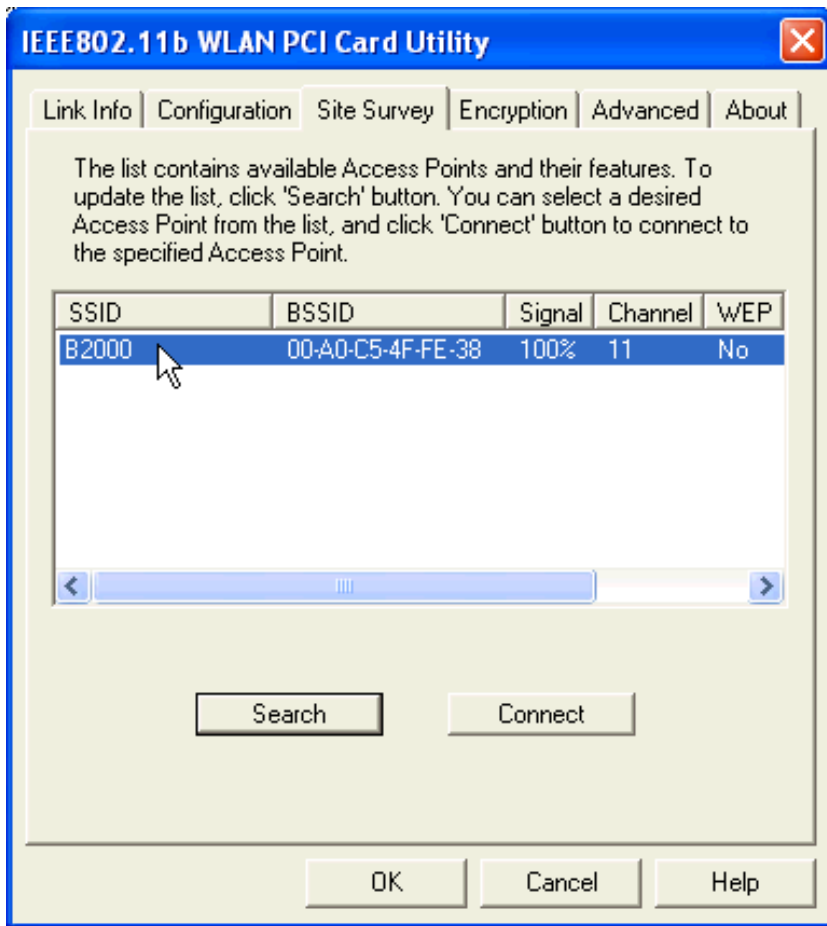

5. Double click on the AP you want to associated with.

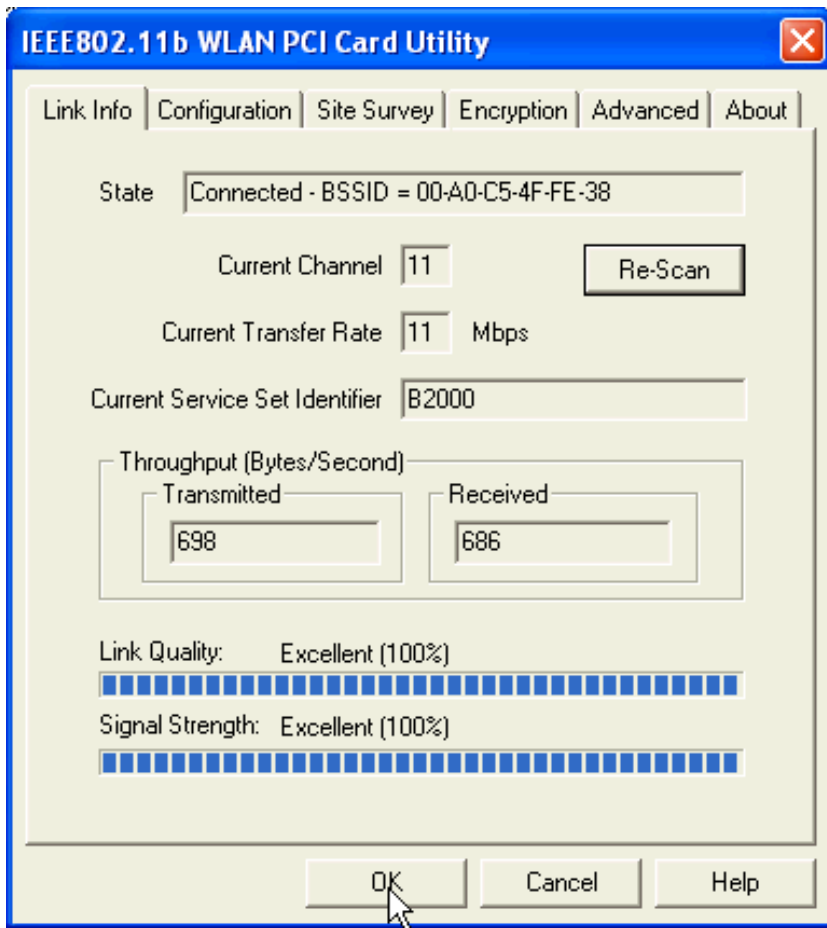

6. After the client have associated with the selected AP. The linked AP's channel, current linkup rate, SSID, link quality, and signal strength will show on the Link Info page. You now successfully associate with the selected AP with Infrastructure Mode.

MAC Filter

- [MAC Filter Overview](#)
- [ZyXEL MAC Filter Implementation](#)
- [Configure the WLAN MAC Filter](#)

1. MAC Filter Overview

Users can use MAC Filter as a method to restrict unauthorized stations from accessing the APs. ZyXEL's APs provide the capability for checking MAC address of the station before allowing it to connect to the network. This provides an additional layer of control layer in that only stations with registered MAC addresses can connect. This approach requires that the list of MAC addresses be configured.

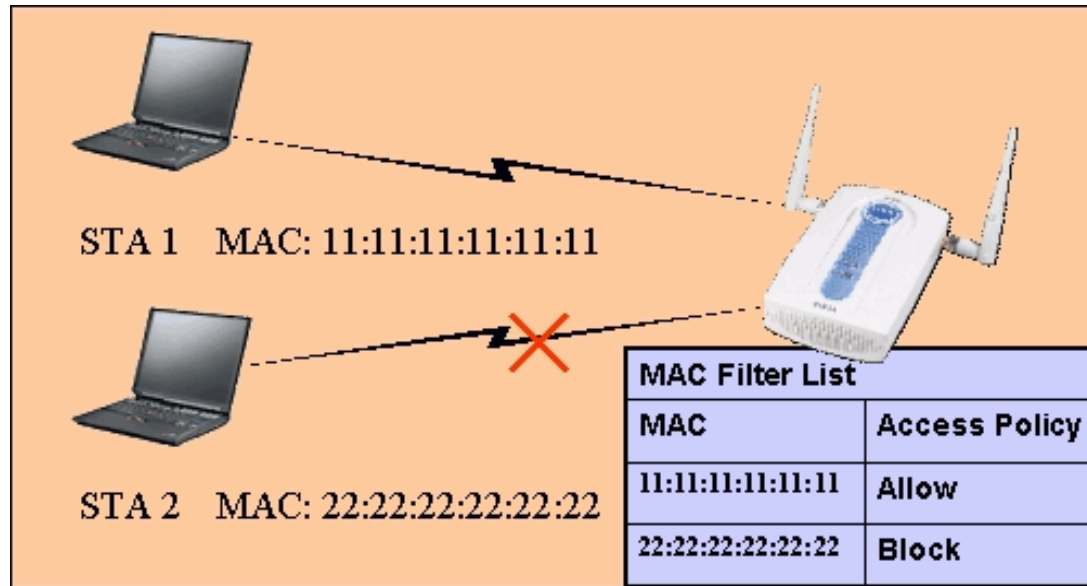

2. ZyXEL MAC Filter Implementation

ZyXEL's MAC Filter Implementation allows users to define a list to allow or block association from STAs. The filter set allows users to input 12 entries in the list. If Allow Association is selected, all other STAs which are not on the list will be denied. Otherwise, if Deny Association is selected, all other STAs which are not on the list will be allowed for association. Users can choose either way to configure their filter rule.

3. Configure the WLAN MAC Filter

The MAC Filter related settings in ZyXEL APs are configured in menu 3.5.1, WLAN MAC Address Filter Configuration. Before you configure the MAC filter, you need to know the MAC address of the client first. If not knowing what your MAC address is, please enter a command "**ipconfig /all**" after DOS prompt to get the MAC (physical) address of your wireless client.

If you use SMT management, the MAC Address Filter configuration are as shown below.

Enter the MAC Addresses of wireless cards in the filter set to allow or deny association from these cards.

```

Menu 3.5.1 - WLAN MAC Address Filter

Active= No

Filter Action= Allowed Association

-----

1= 00:00:00:00:00:00  13= 00:00:00:00:00:00  25= 00:00:00:00:00:00
2= 00:00:00:00:00:00  14= 00:00:00:00:00:00  26= 00:00:00:00:00:00
3= 00:00:00:00:00:00  15= 00:00:00:00:00:00  27= 00:00:00:00:00:00
4= 00:00:00:00:00:00  16= 00:00:00:00:00:00  28= 00:00:00:00:00:00
5= 00:00:00:00:00:00  17= 00:00:00:00:00:00  29= 00:00:00:00:00:00
6= 00:00:00:00:00:00  18= 00:00:00:00:00:00  30= 00:00:00:00:00:00
7= 00:00:00:00:00:00  19= 00:00:00:00:00:00  31= 00:00:00:00:00:00
8= 00:00:00:00:00:00  20= 00:00:00:00:00:00  32= 00:00:00:00:00:00
9= 00:00:00:00:00:00  21= 00:00:00:00:00:00
10= 00:00:00:00:00:00  22= 00:00:00:00:00:00
11= 00:00:00:00:00:00  23= 00:00:00:00:00:00
12= 00:00:00:00:00:00  24= 00:00:00:00:00:00

-----

Enter here to CONFIRM or ESC to CANCEL:

```

Key Settings:

Option	Descriptions
--------	--------------

Filter Action	Allow or block association from MAC addresses contained in this list. If Allow Association is selected in this field, hosts with MAC addresses configured in this list will be allowed to associate with AP. If Deny Association is selected in this field, hosts with MAC addresses configured in this list will be blocked.
MAC Address	This field specifies those MAC Addresses that you want to add in the list.

If you use WEB configuration, the MAC Address Filter configuration are as shown below.

1. Using a web browser, login AP by giving the LAN IP address of AP in URL field. Default LAN IP is **192.168.1.1**, default password to login web configurator is **1234**.
2. Click **Advanced**, and click **Wireless** tab on the left.
3. Click **MAC Filter** tab on the top and select **Yes** in the **Active** field to enable MAC Filter.
4. Select the **Filter Action** to allow or deny association from hosts in the list.
5. Enter the MAC Addresses which you may want to apply the filter to allow or block associations from.
6. Click **Apply** to make your setting work.



WIRELESS LAN

Wireless	MAC Filter	Roaming	802.1x/WPA	Local User Database	RADIUS
MAC Address Filter					
Active		Yes ▼			
Filter Action		Allow Association ▼			
Set	MAC Address	Set	MAC Address		
1	11:11:11:11:11:11	17	00:00:00:00:00:00		
2	00:00:00:00:00:00	18	00:00:00:00:00:00		
3	00:00:00:00:00:00	19	00:00:00:00:00:00		
4	00:00:00:00:00:00	20	00:00:00:00:00:00		
5	00:00:00:00:00:00	21	00:00:00:00:00:00		



6	<input type="text" value="00:00:00:00:00:00"/>	22	<input type="text" value="00:00:00:00:00:00"/>
7	<input type="text" value="00:00:00:00:00:00"/>	23	<input type="text" value="00:00:00:00:00:00"/>
8	<input type="text" value="00:00:00:00:00:00"/>	24	<input type="text" value="00:00:00:00:00:00"/>
9	<input type="text" value="00:00:00:00:00:00"/>	25	<input type="text" value="00:00:00:00:00:00"/>
10	<input type="text" value="00:00:00:00:00:00"/>	26	<input type="text" value="00:00:00:00:00:00"/>
11	<input type="text" value="00:00:00:00:00:00"/>	27	<input type="text" value="00:00:00:00:00:00"/>
12	<input type="text" value="00:00:00:00:00:00"/>	28	<input type="text" value="00:00:00:00:00:00"/>
13	<input type="text" value="00:00:00:00:00:00"/>	29	<input type="text" value="00:00:00:00:00:00"/>
14	<input type="text" value="00:00:00:00:00:00"/>	30	<input type="text" value="00:00:00:00:00:00"/>
15	<input type="text" value="00:00:00:00:00:00"/>	31	<input type="text" value="00:00:00:00:00:00"/>
16	<input type="text" value="00:00:00:00:00:00"/>	32	<input type="text" value="00:00:00:00:00:00"/>

All contents copyright (c) 2002 ZyXEL Communications Corporation.

Setup WEP (Wired Equivalent Privacy)

- [Introduction](#)
- [Setting up the Access Point](#)
- [Setting up the Station](#)

Introduction

The 802.11 standard describes the communication that occurs in wireless LANs.

The Wired Equivalent Privacy (WEP) algorithm is used to protect wireless communication from eavesdropping, because wireless transmissions are easier to intercept than transmissions over wired networks, and wireless is a shared medium, everything that is transmitted or received over a wireless network can be intercepted.

WEP relies on a secret key that is shared between a mobile station (e.g. a laptop with a wireless Ethernet card) and an access point (i.e. a base station). The secret key is used to encrypt packets before they are transmitted, and an integrity check is used to ensure that packages are not modified during the transition. The standard does not discuss how the shared key is established. In practice, most installations use a single key that is shared between all mobile stations and access points APs.

WEP employs the key encryption algorithm, Ron's Code 4 Pseudo Random Number Generator (RC4 PRNG). The same key is used to encrypt and decrypt the data.

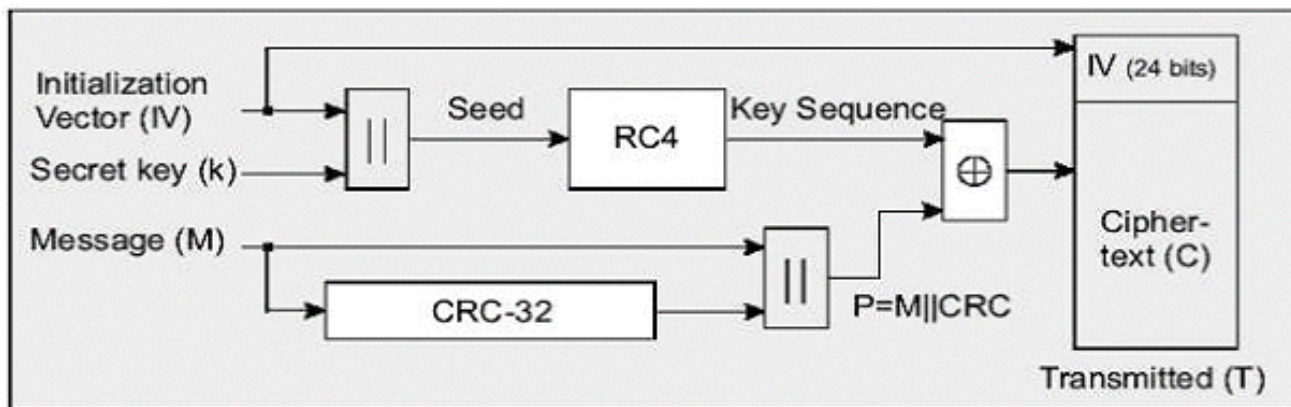

WEP has defences against this attack. To avoid encrypting two cipher texts with the same key stream, an Initialisation Vector (IV) is used to augment the shared WEP key (secret key) and produce a different RC4 key for each packet, the IV is also included in the package. WEP key (secret key) are available in two types, 64-bits and 128-bits. Many times you will see them referenced as 40-bits and 104-bits instead. The reason for this misnomer is that the WEP key (40/104 bits) is

concatenated with the initialisation vector (24 bits) resulting in a 64/128 bit total key size.

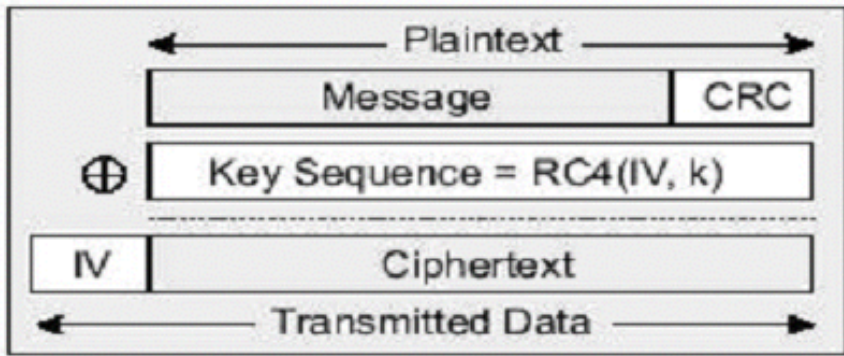

Setting up the Access Point

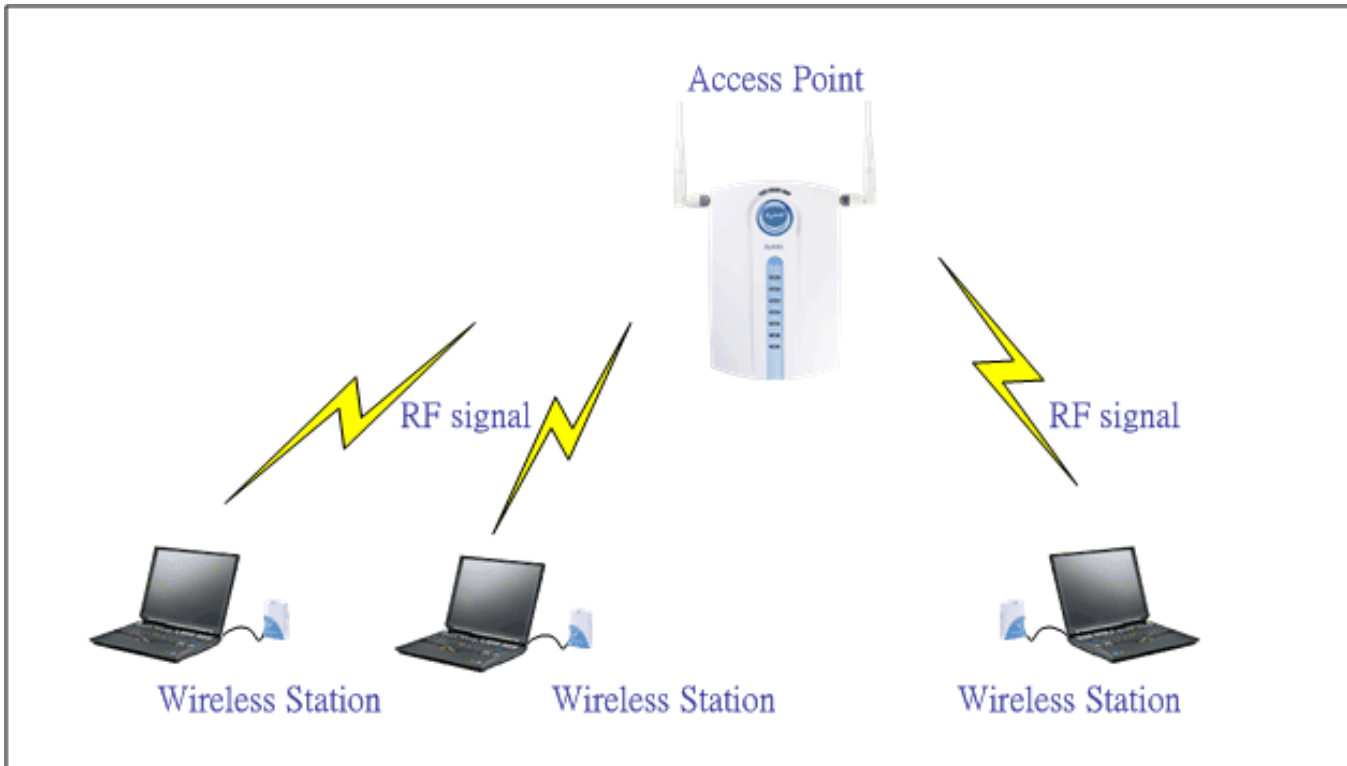

Most access points and clients have the ability to hold up to 4 WEP keys simultaneously. You need to specify one of the 4 keys as default Key for data encryption. To set up the Access Point, you will need to set the one of the following parameters:

- 64-bit WEP key (secret key) with 5 characters
- 64-bit WEP key (secret key) with 10 hexadecimal digits
- 128-bit WEP key (secret key) with 13 characters
- 128-bit WEP key (secret key) with 26 hexadecimal digits

You can set up the Access Point by SMT or Web configurator

- Setting up the Access Point from SMT Menu 3.5

G-5100 hold up to 4 WEP Keys. You have to specify one of the 4 keys as default Key which be used to encrypt wireless data transmission. For example,

```
Menu 3.5 - Wireless LAN Setup

Operaing Mode= Access Point      Edit MAC Address Filter= No
ESSID= Wireless                  Edit Roaming Configuration= No
Hide ESSID= No                   Edit Multiple ESS Configuration= N/A
Channel ID= CH06 2412MHz         Edit Bridge Link Configuration= N/A
RTS Threshold= 2432              Block Intra-BSS Traffic= No
Frag. Threshold= 2432           Number of Associated Stations= 32
WEP Encryption= 64-bit WEP     Breathing LED= Yes

Default Key= 3                  Output Power= 17dBm
Key1= lkasd
Key2= oueww
Key3= wopek
Key4= woppe
Authen. Method= N/A

Press ENTER to Confirm or ESC to Cancel:
```

Key settings

Hexadecimal digits have to preceded by '0x',

WEP Key type	Example
64-bit WEP with 5 characters	Key1= 2e3f4 Key2= 5y7js Key3= 24fg7 Key4= 98jui
64-bit WEP with 10 hexadecimal digits ('0-9', 'A-F')	Key1= 0x123456789A Key2= 0x23456789AB Key3= 0x3456789ABC Key4= 0x456789ABCD
128-bit WEP with 13 characters	Key1= 2e3f4w345ytre Key2= 5y7jse8r4i038 Key3= 24fg70okx3fr7 Key4= 98jui2wss35u4
128-bit WEP with 26 hexadecimal digits ('0-9', 'A-F')	Key1= 0x112233445566778899AABBCDEF Key2= 0x2233445566778899AABBCDDEE Key3= 0x3344556677889900AABCCDDFF Key4= 0x44556677889900AABCCDDEEFF

Select one of the WEP key as default Key to encrypt wireless data transmission.
The receiver will use the corresponding key to decrypt the data.

For example, if access point use Key 3 to encrypt data, then station will use Key 3 to decrypt data.
So, the Key 3 of station has to equal to the Key 3 of access point.

Though access point use Key 3 as default key, but the station can use the other Key as its default key to encrypt wireless data transmission.

Access Point (encrypt data by Key 3) -----> Station (decrypt data by Key 3)

Access Point (decrypt data by Key 2) <----- Station (encrypt data by Key 2)

In this case, access point transmits data to station which encrypt data by Key 3 of access point. The station will decrypt the data by its Key 3.

At the same time, when the station transmits data to access point which encrypt data by Key 2.
The access point will decrypt the data by its Key 2.

- Setting up the Access Point with Web configurator



WIRELESS LAN

WIZARD
SETUP

ADVANCED
SYSTEM

WIRELESS

IP

LOGS

VLAN

MAINTENANCE

LOGOUT

Wireless

MAC Filter

Roaming

802.1x/WPA

Local User
Database

RADIUS

Operating Mode

Access Point

ESSID

Wireless

Hide ESSID

Choose Channel ID

Channel-01 2412MHz

or

Scan

RTS/CTS Threshold

2432

(0 ~ 2432)

Fragmentation Threshold

2432

(256 ~ 2432)

WEP Encryption

64-bit WEP

Authentication Method

Auto

64-bit WEP: Enter 5 characters or 10 digit ("0-9", "A-F") for each Key(1-4).

128-bit WEP: Enter 13 characters or 26 digit ("0-9", "A-F") for each Key(1-4).

(Select one WEP key as an active key to encrypt wireless data transmission.)

ASCII

Hex

Key 1

loads

Key 2

oueww

Key 3

wopek

Key 4

woppe

Enable Breathing LED

Enable Spanning Tree Protocol (STP)

Preamble

Long

802.11 Mode

Mixed

Max. Frame Burst

650

(0 ~1800)

VLAN ID

0

(1 ~255)

Apply

Reset



Key settings

Select one WEP key as default key to encrypt wireless data transmission.

Setting up the Station

1. Double click on the utility icon in your windows task bar or right click the utility icon then select 'Show Config Utility'.



The utility will pop up on your windows screen.

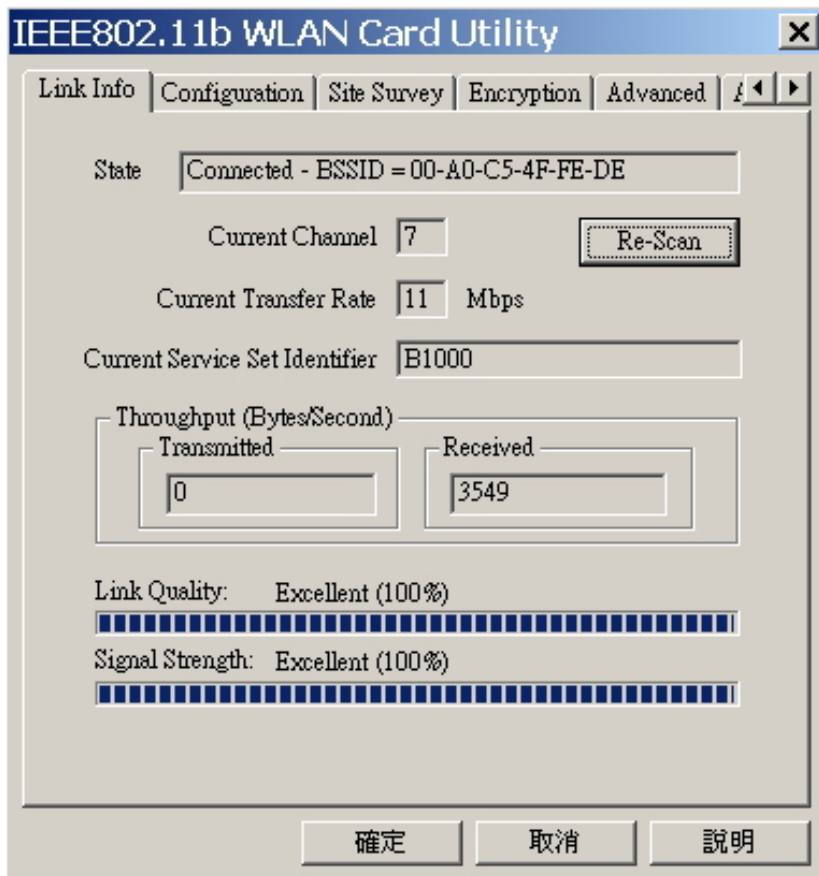

Note: If the utility icon doesn't exist in your task bar, click Start -> Programs -> IEEE802.11b WLAN Card -> IEEE802.11b WLAN Card.

2. Select the 'Encryption' tab.

Select encryption type correspond with access point.

Set up 4 Keys which correspond with the WEP Keys of access point.

And select on WEP key as default key to encrypt wireless data transmission.

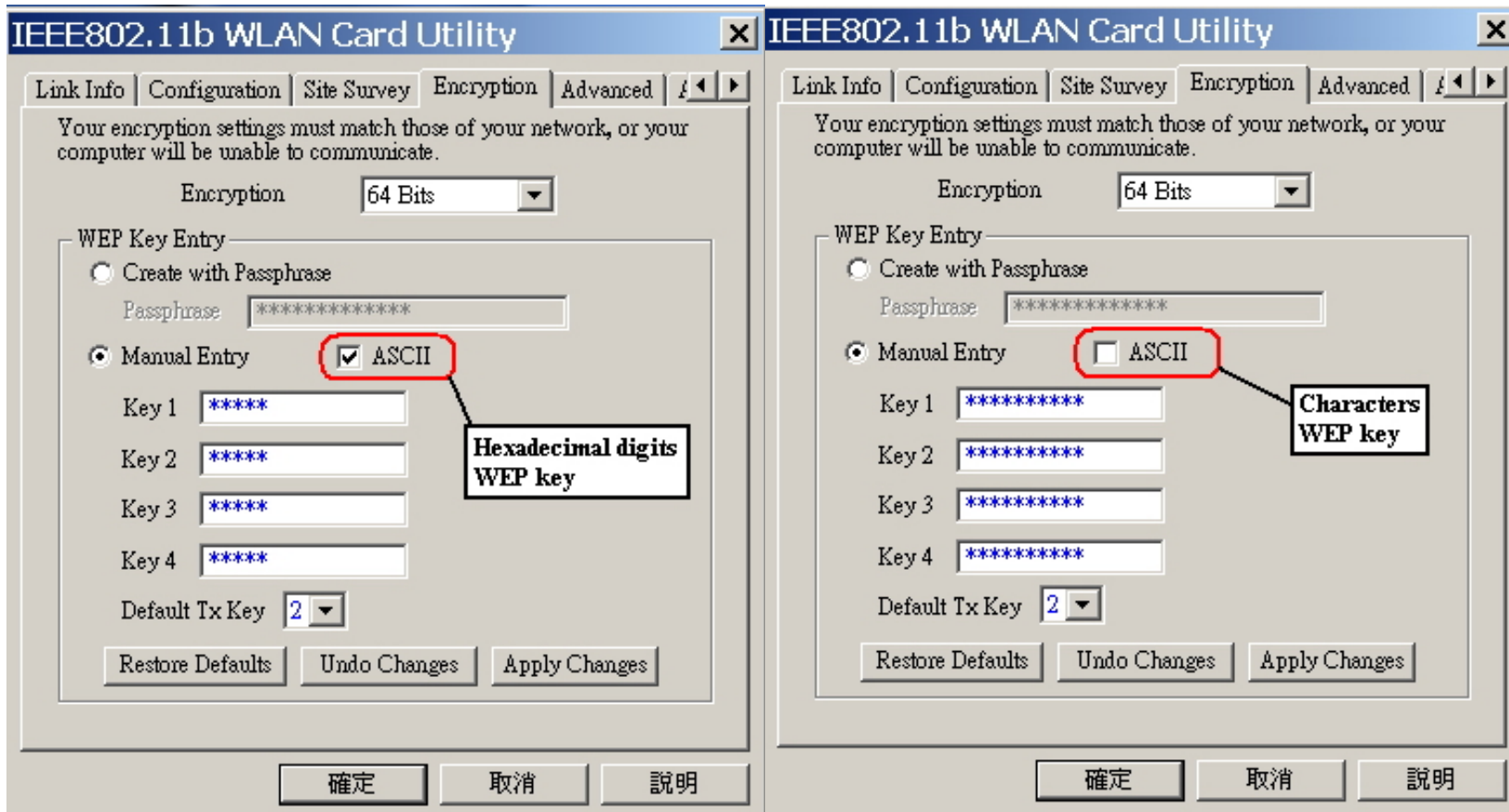

Key settings

The WEP Encryption type of station has to equal to the access point.

Check 'ASCII' field for characters WEP key or **uncheck 'ASCII'** field for Hexadecimal digits WEP key.

Hexadecimal digits don't need to be preceded by '0x'.

For example,

64-bits with characters WEP key :

Key1= loads

Key2= oueww

Key3= wopek

Key4= woppe

64-bits with hexadecimal digits WEP key :

Key1= 123456789A

Key2= 23456789AB

Key3= 3456789ABC

Key4= 456789ABCD

All contents copyright © 2002 ZyXEL Communications Corporation.

Configure Access Point for Roaming

- [Introduction](#)
- [Configure Access Point 1 for roaming using SMT](#)
- [Configure Access Point 2 for roaming using SMT](#)
- [Configure Access Point 1 for roaming using Web configurator](#)
- [Configure Access Point 2 for roaming using Web configurator](#)

i@

- **Introduction**

What is Roaming?

In a network environment with multiple access points, wireless stations are able to switch from one access point to another as they move between the coverage areas. During this period, the wireless station maintains uninterrupted connection to the network. This is roaming. As the wireless station moves from place to place, it is responsible for choosing the most appropriate access point depending on the signal strength, network utilization or other factors.

i@

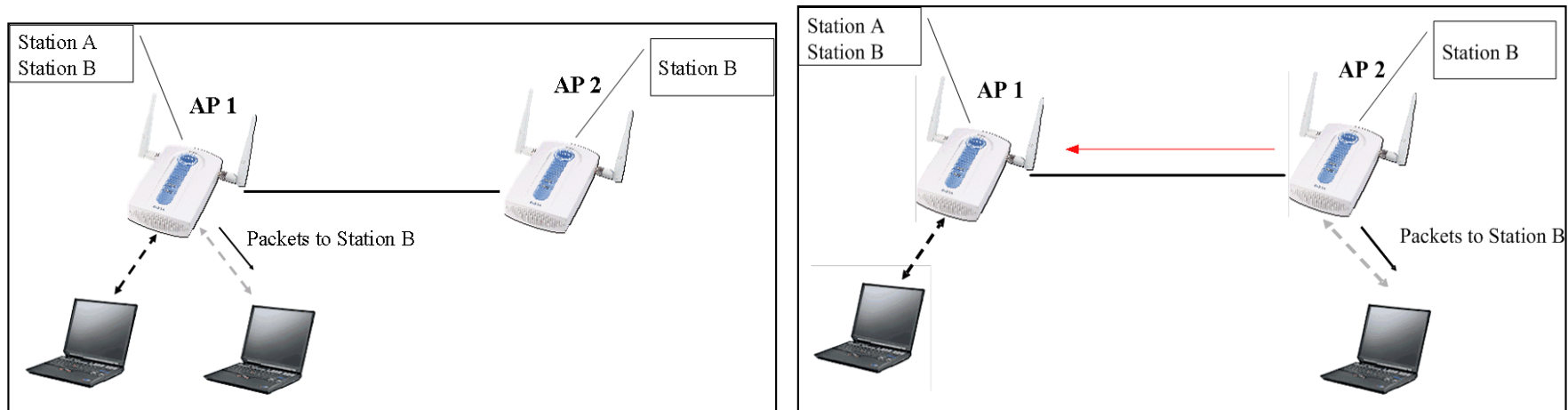

- **Configuration API for Roaming using SMT**

To Enable the roaming feature if you have two or more ZyAIRs on the same subnet. Follow the steps below to allow roaming on your ZyAIR.

1. From the SMT main menu, enter 3 to display Menu 3 ;V LAN Setup.
2. Enter 5 to display Menu 3.5 ;V Wireless LAN Setup.

```
Menu 3.5 - Wireless LAN Setup

Operaing Mode= Access Point      Edit MAC Address Filter= No
ESSID= Wireless                  Edit Roaming Configuration= Yes
Hide ESSID= No                   Edit Multiple ESS Configuration= N/A
Channel ID= CH06 2412MHz         Edit Bridge Link Configuration= N/A
RTS Threshold= 2432              Block Intra-BSS Traffic= No
Frag. Threshold= 2432            Number of Associated Stations= 32
WEP Encryption= Disable         Breathing LED= Yes

Default Key= N/A                 Output Power= 17dBm
Key1= N/A
Key2= N/A
Key3= N/A
Key4= N/A
Authen. Method= N/A

Press ENTER to Confirm or ESC to Cancel:

;@
```

3. Move the cursor to the Edit Roaming Configuration field. Press [SPACE BAR] to select Yes and then press [ENTER]. Menu 3.5.2 Roaming Configuration displays as shown next.

```
Menu 3.5.2 - Roaming Configuration

Active= Yes
Port #= 3517

Press ENTER to Confirm or ESC to Cancel:

;@
```

;@

- **Configuration AP2 for Roaming using SMT**

To Enable the roaming feature if you have two or more ZyAIRs on the same subnet. Follow the steps below to allow roaming on your ZyAIR.

1. From the SMT main menu, enter 3 to display Menu 3 ;V LAN Setup.
2. Enter 5 to display Menu 3.5 ;V Wireless LAN Setup.

```
Menu 3.5 - Wireless LAN Setup

Operaing Mode= Access Point      Edit MAC Address Filter= No
ESSID= Wireless                  Edit Roaming Configuration= Yes
Hide ESSID= No                   Edit Multiple ESS Configuration= N/A
Channel ID= CH06 2412MHz         Edit Bridge Link Configuration= N/A
RTS Threshold= 2432             Block Intra-BSS Traffic= No
Frag. Threshold= 2432           Number of Associated Stations= 32
WEP Encryption= Disable         Breathing LED= Yes

Default Key= N/A                 Output Power= 17dBm
Key1= N/A
Key2= N/A
Key3= N/A
Key4= N/A
Authen. Method= N/A

Press ENTER to Confirm or ESC to Cancel:
```

3. Move the cursor to the Edit Roaming Configuration field. Press [SPACE BAR] to select Yes and then press [ENTER]. Menu 3.5.2 Roaming Configuration displays as shown next.

Menu 3.5.2 - Roaming Configuration

Active= Yes
Port #= 3517

Press ENTER to Confirm or ESC to Cancel:

¡@

field	description
Active	Press [SPACE BAR] and then [ENTER] to select Yes to enable roaming on the ZyAIR if you have two or more ZyAIRs on the same subnet.
Port #	Enter the port number to communicate roaming information between access points. The port number must be the same on all access points. The default is 3517 . Make sure this port is not used by other services.
When you have completed this menu, press [ENTER] at the prompt ¡\$Press ENTER to confirm or ESC to cancel¡” to save your configuration or press [ESC] to cancel and go back to the previous screen.	

4. Requirements for Roaming

The following requirements must be met in order for wireless stations to roam between the coverage areas.

1. All the access points and wireless stations must be on the same subnet, configured with the same ESSID and security settings such as WEP.
2. If IEEE 802.1X user authentication is enabled and to be done locally on the access point, the new access point must have the user profile for the wireless station.
3. The adjacent access points should use different radio channels when their coverage areas overlap to provide seamless roaming.
4. All access points must use the same port number to relay roaming information.

- ***Configuration API for Roaming using Web configurator***

To Enable the roaming feature if you have two or more ZyAIRs on the same subnet. Follow the steps below to allow roaming on your ZyAIR.

1. From the Web configurator main menu, Click Advanced->>wireless than select roaming tab in wireless page.

[WIZARD
SETUP](#)[ADVANCED
SYSTEM
WIRELESS](#)[IP](#)[LOGS](#)[VLAN](#)[MAINTENANCE](#)[LOGOUT](#)

WIRELESS LAN

Wireless	MAC Filter	Roaming	802.1x/WPA	Local User Database	RADIUS
Roaming Configuration					
Active		Yes ▾			
Port		3517			
		Apply	Reset		

2. Select 'Yes' from the pull down menu under Roaming configuration and specify the roaming port.

3. Upon completion click Apply to make configuration take effect.

- *Configuration AP2 for Roaming using Web configurator*

To Enable the roaming feature if you have two or more ZyAIRs on the same subnet. Follow the steps below to allow roaming on your ZyAIR.

1. From the Web configurator main menu, Click Advanced->>wireless than select roaming tab in wireless page.

WIRELESS LAN

Wireless	MAC Filter	Roaming	802.1x/WPA	Local User Database	RADIUS
Roaming Configuration					
Active		Yes ▾			
Port		3517			
		Apply	Reset		

2. Select 'Yes' from the pull down menu under Roaming configuration and specify the roaming port.

3. Upon completion click Apply to make configuration take effect.

field	description
Active	Use the pull down menu to select Yes to enable roaming on the ZyAIR if you have two or more ZyAIRs on the same subnet.
Port #	Enter the port number to communicate roaming information between access points. The port number must be the same on all access points. The default is 3517 . Make sure this port is not used by other services.
When you have completed this menu, press [Apply] on the bottom of the page for the configuration to take effect.	

4. Requirements for Roaming

The following requirements must be met in order for wireless stations to roam between the coverage areas.

1. All the access points and wireless stations must be on the same subnet, configured with the same ESSID and security settings such as WEP.
2. If IEEE 802.1X user authentication is enabled and to be done locally on the access point, the new access point must have the user profile for the wireless station.

3. The adjacent access points should use different radio channels when their coverage areas overlap to provide seamless roaming.
4. All access points must use the same port number to relay roaming information.

Site Survey

- [Site survey introduction](#)
 - [Preparation](#)
 - [Survey on site](#)
-

- ***Introduction***

What is Site Survey?

An RF site survey is a MAP to RF contour of RF coverage in a particular facility. With wireless system it is very difficult to predict the propagation of radio waves and detect the presence of interfering signals. Walls, doors, elevator shafts, and other obstacles offer different degree of attenuation. This will cause the RF coverage pattern be irregular and hard to predict.

Site survey can help us overcome these problem and even provide us a map of RF coverage of the facility.

Preparation

Below are the step to complete a simple site survey with simple tools.

1. First you will need to Obtain a facility diagram, such as a blueprints. This is for you to mark and take record on.
 2. Visually inspect the facility, walk through the facility to verify the accuracy of the diagram and mark down any large obstacle you see that may effect the RF signal such as metal shelf, metal desk, etc on the diagram.
 3. Identify user's area, when doing so ask a question where is wireless coverage needed and where does not, and note and take note on the diagram this is information is needed to determine the number of AP required.
 4. Determine the preliminary access point location on the facility diagram base on the service area needed, obstacles, power wall jack considerations.
-

Survey on Site

1. With the diagram with all information you gathered in the preparation phase. Now you are ready to make the survey.

2. Install an access point at the preliminary location.
3. Use a notebook with wireless client installed and run it's utility. An utility will provide information such as connection speed, current used channel, associated rate, link quality, signal strength and etc information as shown in utility below.

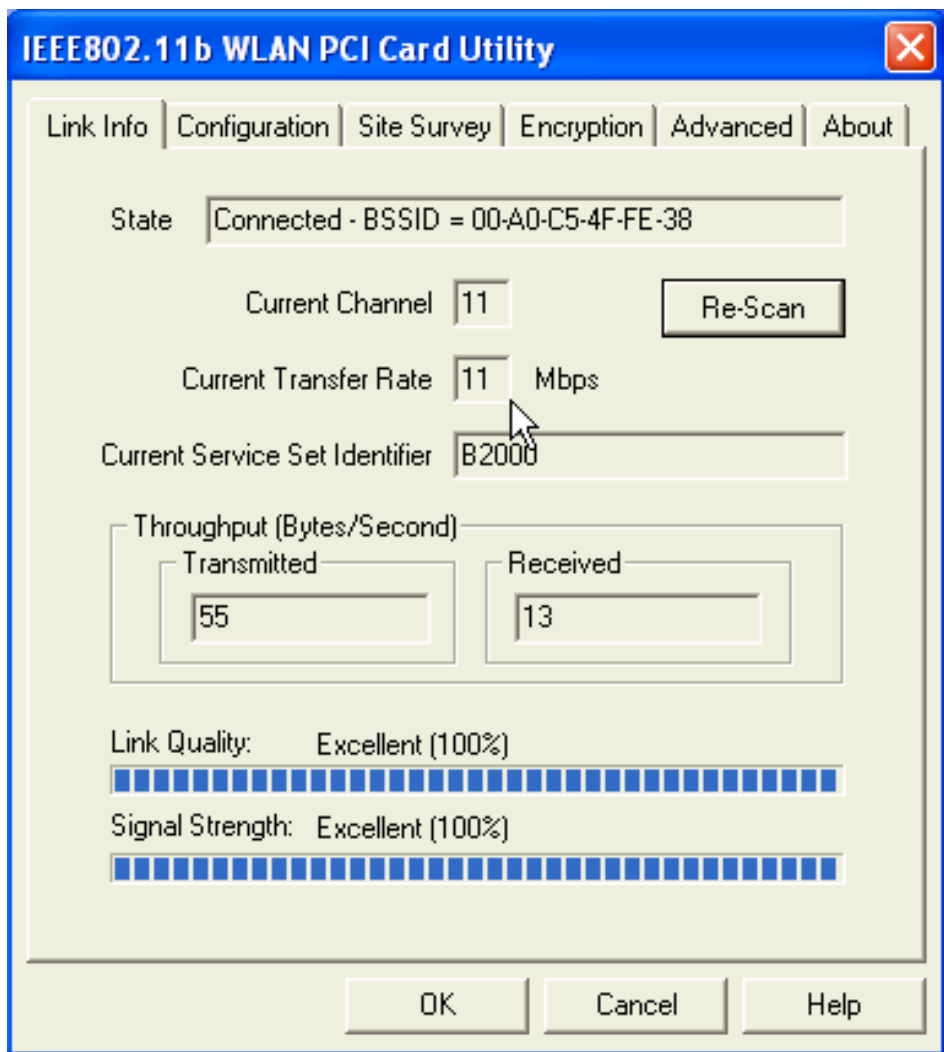

4. It's always a good idea to start with putting the access point at the corner of the room and walk away from the access point in a systematic manner. Record down the changes at point where transfer rate drop and the link quality and signal strength information on the diagram as you go alone.

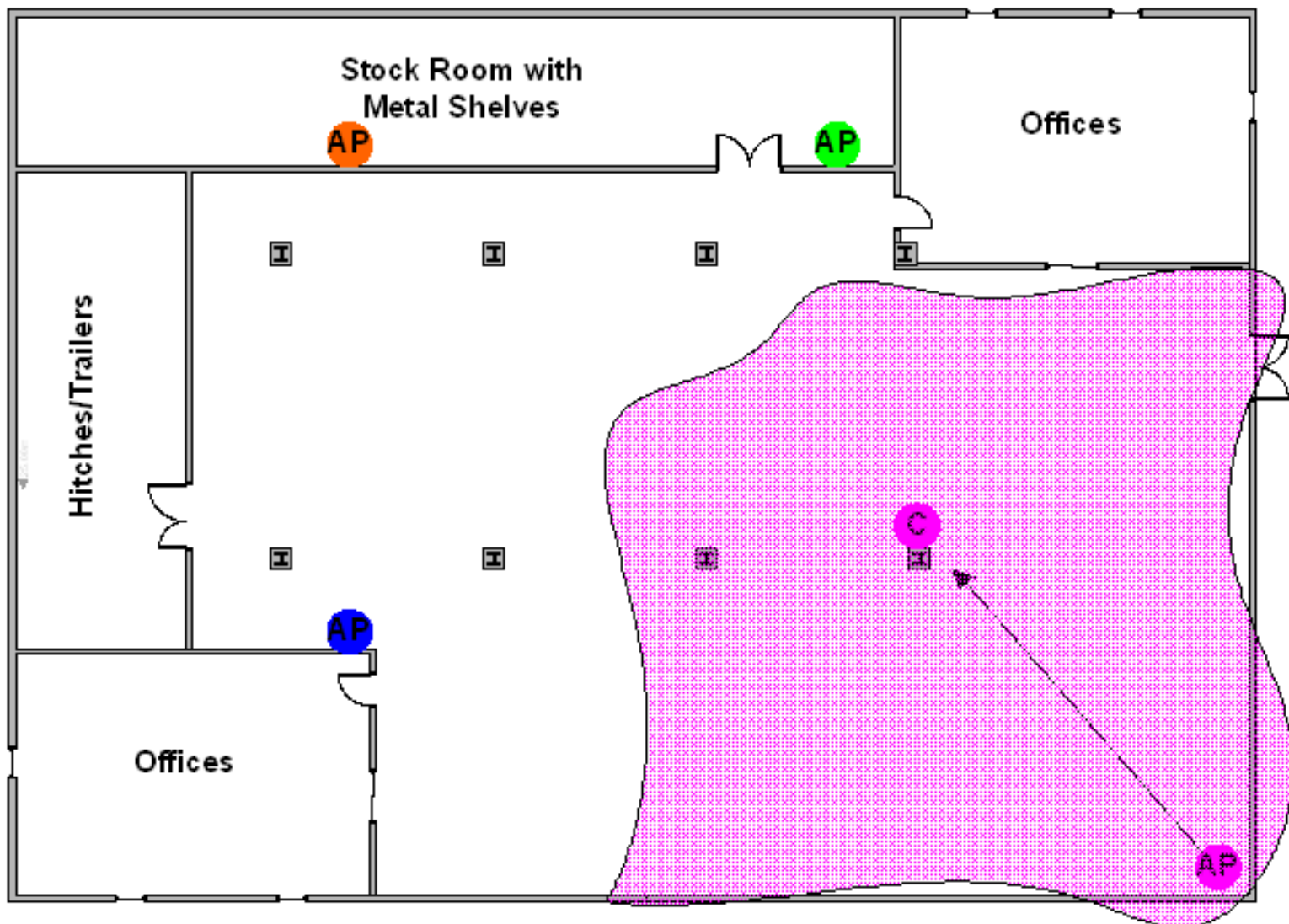

5. When you reach the farthest point of connection mark the spot. Now you move the access point to this new spot as have already determine the farthest point of the access point installation spot if wireless service is required from corner of the room.

6. Repeat step 1~5 and now you should be able to mark an RF coverage area as illustrated in above picutre.

7. You may need more than one access point is the RF coverage area have not cover all the wireless service area you needed.

8. Repeat step 1~6 of survey on site as necessary, upon completion you will have an diagram and information of site survey. As illustrated below.

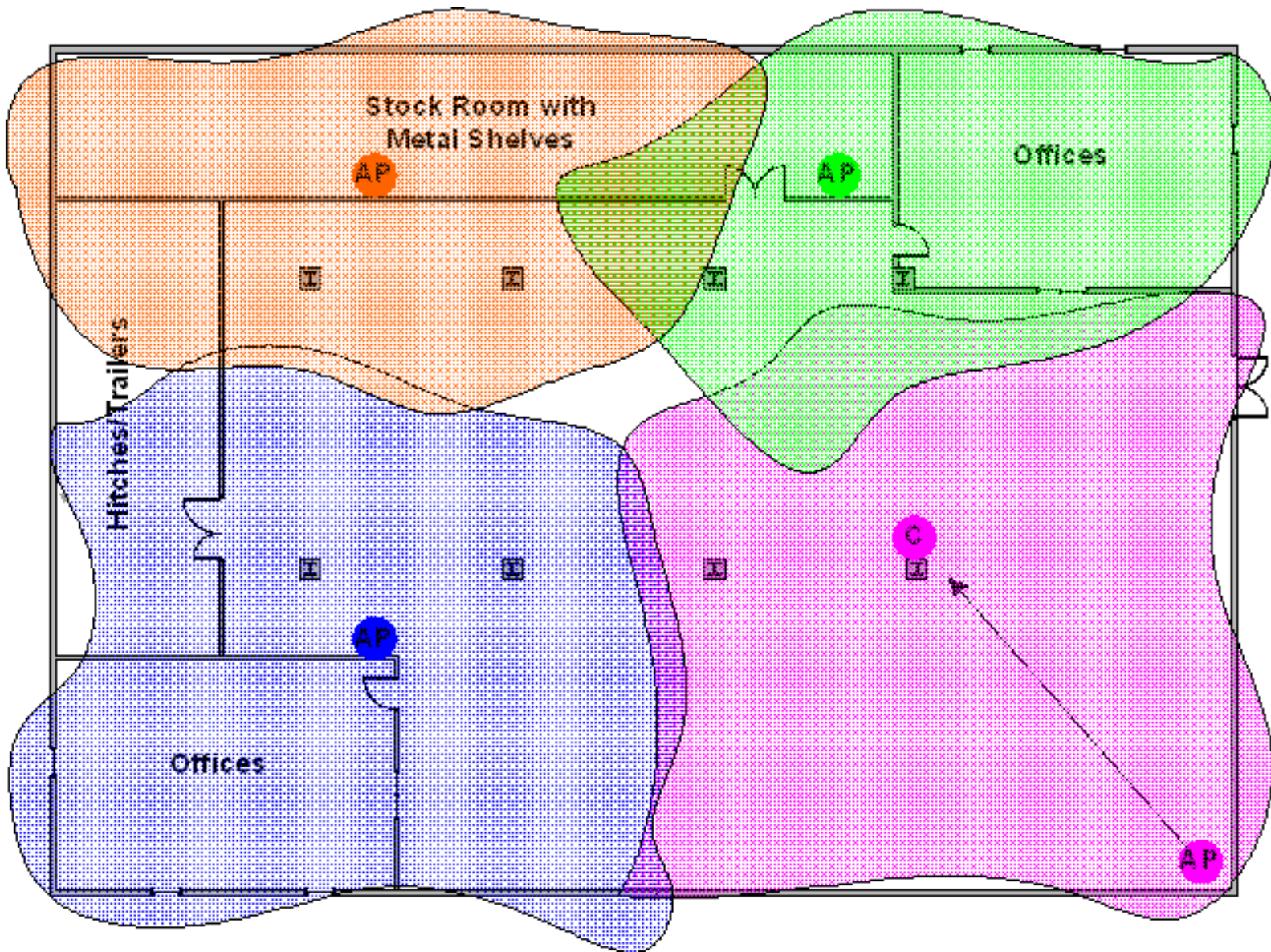

Note: If there are more than one access point is needed be sure to make the adjacent access point service area overlap one another. So the wireless station are able to roam. For more information please refer to roaming at

Configure Access Point as a Repeater mode

- [Repeater Introduction](#)
 - [Configuration for wireless station 1](#)
 - [Configuration for wireless station 2](#)
 - [Configuration for wireless station 3](#)
-

- ***Introduction***

What is Repeater Functionality?

A multiple Distribution System(DS) is a wired connection between two or more bridge/repeater devices. While a Wireless Distribution System(WDS) is a wireless connection. The ZyAIR G-5100 support Repeater, providing a like repeater solution for wireless network expansion. Basically, it's still a bridge device that all of traffic is transparent through the device.

The ZyAIR G-5100 can function as a wireless network bridge/repeater links with other bridge/repeater.

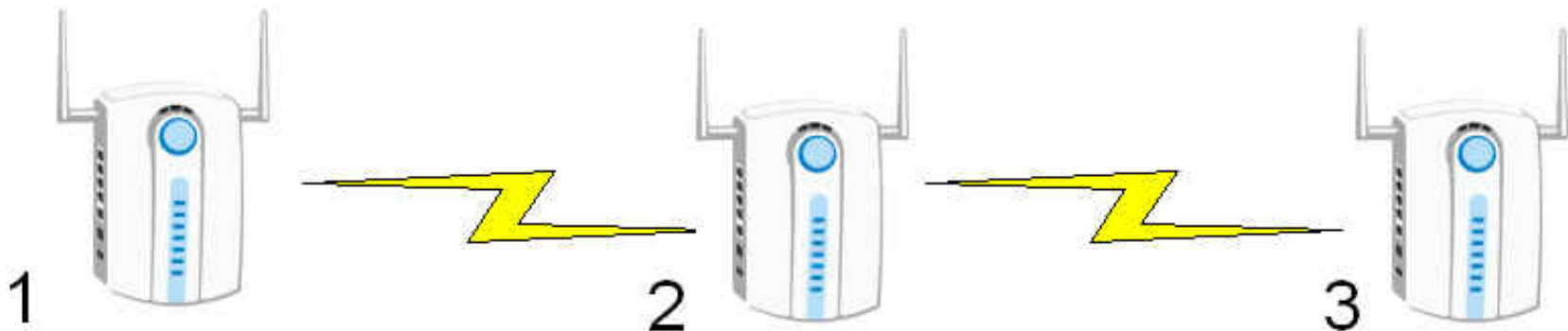

- ***Configuration for Wireless Station 1***

The ZyAIR G-5100 can function as wireless network bridge/repeater. You need to know the MAC address of the peer device, which also must be in bridge/repeater mode.

The repeater mode is the bridge mode without the Ethernet connection. When the ZyAIR G-5100 is in the bridge/repeater mode, you need to enable STP to prevent bridge loops.

1. Click **Advanced** and **Wireless**.
2. Select **Bridge/Repeater** in the **Operation Mode** drop-down list box to display the screen as down.
3. Type the MAC address of peer device in the **Remote Bridge MAC Address** field, that is, six hexadecimal character pairs.
4. Click **Apply** to finish.

ZyXEL

WIZARD SETUP

ADVANCED SYSTEM

WIRELESS

IP

LOGS

VLAN

MAINTENANCE

LOGOUT

WIRELESS LAN

Wireless

Operating Mode: Bridge/Repeater

Choose Channel ID: Channel-06 2437MHz or Scan

RTS/CTS Threshold: 2432 (0 ~ 2432)

Fragmentation Threshold: 2432 (256 ~ 2432)

Enable WDS Security

#	Active	Remote Bridge MAC Address	PSK
1	<input checked="" type="checkbox"/>	00:a0:c5:00:00:01	
2	<input checked="" type="checkbox"/>	00:a0:c5:00:00:03	
3	<input type="checkbox"/>	00:00:00:00:00:00	
4	<input type="checkbox"/>	00:00:00:00:00:00	
5	<input type="checkbox"/>	00:00:00:00:00:00	
6	<input type="checkbox"/>	00:00:00:00:00:00	
7	<input type="checkbox"/>	00:00:00:00:00:00	
8	<input type="checkbox"/>	00:00:00:00:00:00	



<input checked="" type="checkbox"/> Enable Breathing LED	
<input checked="" type="checkbox"/> Enable Spanning Tree Protocol (STP)	
Preamble	Long
802.11 Mode	Mixed
Max. Frame Burst	650 (0 ~1800)
VLAN ID	0 (1 ~255)

- *Configuration for Wireless Station 2*

1. Click **Advanced** and **Wireless**.
2. Select **Bridge/Repeater** in the **Operation Mode** drop-down list box to display the screen as down.
3. Type the MAC address of peer device in the **Remote Bridge MAC Address** field, that is, six hexadecimal character pairs.
4. Click **Apply** to finish.



WIRELESS LAN

Wireless	
Operating Mode	Bridge/Repeater
Choose Channel ID	Channel-06 2437MHz
RTS/CTS Threshold	2432 (0 ~ 2432)
Fragmentation Threshold	2432 (256 ~ 2432)

 Enable WDS Security

#	Active	Remote Bridge MAC Address	PSK
1	<input checked="" type="checkbox"/>	00:a0:c5:00:00:01	
2	<input checked="" type="checkbox"/>	00:a0:c5:00:00:03	
3	<input type="checkbox"/>	00:00:00:00:00:00	
4	<input type="checkbox"/>	00:00:00:00:00:00	
5	<input type="checkbox"/>	00:00:00:00:00:00	
6	<input type="checkbox"/>	00:00:00:00:00:00	
7	<input type="checkbox"/>	00:00:00:00:00:00	
8	<input type="checkbox"/>	00:00:00:00:00:00	

 Enable Breathing LED
 Enable Spanning Tree Protocol (STP)

Preamble

Long

802.11 Mode

Mixed

Max. Frame Burst

650 (0 ~1800)

VLAN ID

0 (1 ~255)

Apply

Reset

- **Configuration for Wireless Station 3**

1. Click **Advanced** and **Wireless**.
2. Select **Bridge/Repeater** in the **Operation Mode** drop-down list box to display the screen as down.
3. Type the MAC address of peer device in the **Remote Bridge MAC Address** field, that is, six hexadecimal character pairs.
4. Click **Apply** to finish.



WIRELESS LAN

Wireless

Operating Mode Bridge/Repeater

Choose Channel ID Channel-06 2437MHz

RTS/CTS Threshold 2432 (0 ~ 2432)

Fragmentation Threshold 2432 (256 ~ 2432)

Enable WDS Security

#	Active	Remote Bridge MAC Address	PSK
1	<input checked="" type="checkbox"/>	00:a0:c5:00:00:02	
2	<input type="checkbox"/>	00:00:00:00:00:00	
3	<input type="checkbox"/>	00:00:00:00:00:00	
4	<input type="checkbox"/>	00:00:00:00:00:00	
5	<input type="checkbox"/>	00:00:00:00:00:00	
6	<input type="checkbox"/>	00:00:00:00:00:00	
7	<input type="checkbox"/>	00:00:00:00:00:00	
8	<input type="checkbox"/>	00:00:00:00:00:00	

Enable Breathing LED

Enable Spanning Tree Protocol (STP)

Preamble Long

802.11 Mode Mixed

Max. Frame Burst 650 (0 ~1800)

VLAN ID 0 (1 ~255)

Configure Access Point as a AP + bridge/repeater mode

- [AP + Bridge mode Introduction](#)
 - [Configuration for wireless station A](#)
 - [Configuration for wireless station B](#)
-

- ***Introduction***

What is AP+Bridge mode Functionality?

Wireless station can only associated with device in access point mode. If a device is configured in bridge/repeater mode it means the other peer is another bridge/repeater not a wireless station. ZyXEL implement a new feature letting the Access point & bridge/repeater function mixed in the same device.

In AP+Bridge mode, the ZyAIR G-5100 support both AP(the wireless station can connect to the wired network through AP) and bridge(two APs can communicate with one another) connection at the same time.

Note: When the ZyAIR G-5100 is in AP+Bridge mode, the traffic between ZyAIRs(WDS) is not encrypted. The security settings on the ZyAIR refer to the traffic between the wireless station and the ZyAIR.

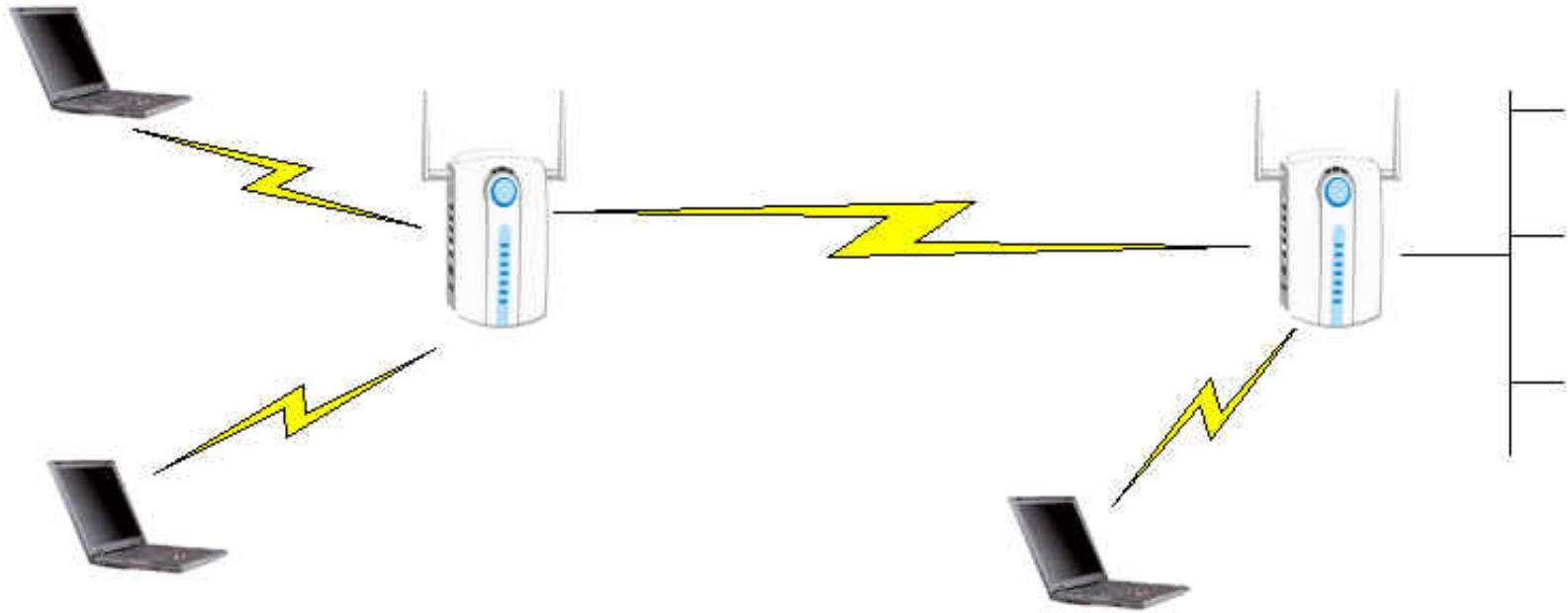

• *Configuration for Wireless Station A*

1. Click **Advanced** and **Wireless**.
2. Select **AP+Bridge** in the **Operation Mode** drop-down list box to display the screen as down.
3. Type a name to identify the ZyAIR in the wireless LAN(up to 32 characters) as the **ESSID**.
4. Select the **Channel** in the **Choose Channel ID** field.
5. Type the MAC address of peer device in the **Remote Bridge MAC Address** field, that is, six hexadecimal character pairs.
6. Click **Apply** to finish.



WIRELESS LAN

Wireless	MAC Filter	Roaming	802.1x/WPA	Local User Database	RADIUS
-----------------	-------------------	----------------	-------------------	----------------------------	---------------

ADVANCED
SYSTEM
WIRELESS

IP
LOGS
VLAN

MAINTENANCE

LOGOUT

Operating Mode

AP+Bridge

ESSID

Wireless A

Hide ESSID

Choose Channel ID

Channel-01 2412MHz

or

Scan

RTS/CTS Threshold

2432

(0 ~ 2432)

Fragmentation Threshold

2432

(256 ~ 2432)

WEP Encryption

Disable

Authentication Method

Auto

64-bit WEP: Enter 5 characters or 10 digit ("0-9", "A-F") for each Key(1-4).

128-bit WEP: Enter 13 characters or 26 digit ("0-9", "A-F") for each Key(1-4).

(Select one WEP key as an active key to encrypt wireless data transmission.)

ASCII

Hex

Key 1

Key 2

Key 3

Key 4

#	Active	Remote Bridge MAC Address	PSK
1	<input checked="" type="checkbox"/>	00:a0:c5:00:00:02	<input type="text"/>
2	<input type="checkbox"/>	00:00:00:00:00:00	<input type="text"/>
3	<input type="checkbox"/>	00:00:00:00:00:00	<input type="text"/>
4	<input type="checkbox"/>	00:00:00:00:00:00	<input type="text"/>
5	<input type="checkbox"/>	00:00:00:00:00:00	<input type="text"/>
6	<input type="checkbox"/>	00:00:00:00:00:00	<input type="text"/>
7	<input type="checkbox"/>	00:00:00:00:00:00	<input type="text"/>
8	<input type="checkbox"/>	00:00:00:00:00:00	<input type="text"/>

<input checked="" type="checkbox"/> Enable Breathing LED	
<input checked="" type="checkbox"/> Enable Spanning Tree Protocol (STP)	
Preamble	Long
802.11 Mode	Mixed
Max. Frame Burst	650 (0 ~1800)
VLAN ID	0 (1 ~255)

- *Configuration for Wireless Station B*

1. Click **Advanced** and **Wireless**.
2. Select **AP+Bridge** in the **Operation Mode** drop-down list box to display the screen as down.
3. Type a name to identify the ZyAIR in the wireless LAN(up to 32 characters) as the **ESSID**.
4. Select the **Channel** in the **Choose Channel ID** field.
5. Type the MAC address of peer device in the **Remote Bridge MAC Address** field, that is, six hexadecimal character pairs.
6. Click **Apply** to finish.



WIRELESS LAN

Wireless	MAC Filter	Roaming	802.1x/WPA	Local User Database	RADIUS
Operating Mode					
<div style="text-align: right;"> <input type="button" value="AP+Bridge"/> </div>					

- ADVANCED
- SYSTEM
- WIRELESS**
- IP
- LOGS
- VLAN

- MAINTENANCE

- LOGOUT

ESSID

Wireless B

Hide ESSID

Choose Channel ID

Channel-01 2412MHz

or

Scan

RTS/CTS Threshold

2432

(0 ~ 2432)

Fragmentation Threshold

2432

(256 ~ 2432)

WEP Encryption

Disable

Authentication Method

Auto

64-bit WEP: Enter 5 characters or 10 digit ("0-9", "A-F") for each Key(1-4).

128-bit WEP: Enter 13 characters or 26 digit ("0-9", "A-F") for each Key(1-4).

(Select one WEP key as an active key to encrypt wireless data transmission.)

ASCII

Hex

Key 1

Key 2

Key 3

Key 4

#	Active	Remote Bridge MAC Address	PSK
1	<input checked="" type="checkbox"/>	00:a0:c5:00:00:01	
2	<input type="checkbox"/>	00:00:00:00:00:00	
3	<input type="checkbox"/>	00:00:00:00:00:00	
4	<input type="checkbox"/>	00:00:00:00:00:00	
5	<input type="checkbox"/>	00:00:00:00:00:00	
6	<input type="checkbox"/>	00:00:00:00:00:00	
7	<input type="checkbox"/>	00:00:00:00:00:00	
8	<input type="checkbox"/>	00:00:00:00:00:00	

Enable Breathing LED

- Enable Breathing LED
- Enable Spanning Tree Protocol (STP)

Preamble

Long

802.11 Mode

Mixed

Max. Frame Burst

650 (0 ~1800)

VLAN ID

0 (1 ~255)

Apply

Reset

Configure 802.1x and WPA

- [What is the WPA Functionality?](#)
 - [Configuration for Access Point](#)
 - [Configuration for your PC](#)
-

- ***Introduction***

What is WPA Functionality?

Wi-Fi Protected Access (WPA) is a subset of the IEEE 802.11i security specification draft. Key differences between WAP and WEP are user authentication and improved data encryption WAP applies IEEE 802.1x Extensible Authentication Protocol (EAP) to authenticate wireless clients using an external RADIUS database. You can not use the ZyAIR's local user database for WPA authentication purpose since the local user database uses MD5 EAP which can not to generate keys.

WPA improves data encryption by using Temporal Key Integrity Protocol (TKIP), Message Integrity Check and IEEE 802.1x. Temporal Key Integrity Protocol uses 128-bits keys that are dynamically generated and distributed by the authentication server. It includes a per-packet key mixing function, a Message Integrity Check (MIC) named Michael, an extend initialization vector (IV) with sequencing rules and a re-keying mechanism.

If you do not have an external RADIUS, server, you should use WPA-PSK (WPA Pre-Share Key) that only requires a single (identical) password entered into each access point, wireless gateway and wireless client. As long as the password match, a client will be granted access to a WLAN.

Here comes **WPA-PSK Application example** for your reference.



- *Configuration for Access point*

The IEEE 802.1x standard outlines enhanced security methods for both the authentication of wireless stations and encryption key management. Authentication can be done using local user database internal to the ZyAIR (authenticate up to 32 users) or an external RADIUS server for an unlimited number of users.

1. To change your ZyAIR's authentication settings, click the wireless **Wireless** link under Advanced.
2. Select **802.1x/WPA** tab.
3. choose **Authentication Required** from the **Wireless Port Control**.
4. Select the **WAP-PSK** in the **Key Management Protocol** field.
5. Type the Pre Shared Key in the **Pre-Shared Key** field.

6. Click **Apply** to finish.

The screenshot shows the ZyXEL WIRELESS LAN configuration interface. The left sidebar contains navigation options: WIZARD SETUP, ADVANCED SYSTEM, WIRELESS (highlighted with a red circle), IP, LOGS, VLAN, MAINTENANCE, and LOGOUT. The main content area is titled 'WIRELESS LAN' and has several tabs: Wireless, MAC Filter, Roaming, 802.1x/WPA (highlighted with a red circle), Local User Database, and RADIUS. The 802.1x/WPA tab is active, showing the following settings:

- 802.1X Authentication: Authentication Required (dropdown menu, highlighted with a red circle)
- Wireless Port Control: 1800 (In Seconds)
- ReAuthentication Timer: 3600 (In Seconds)
- Idle Timeout: 3600 (In Seconds)
- Key Management Protocol: WPA-PSK (dropdown menu, highlighted with a red circle)
- Pre-Shared Key: 12345678
- WPA Mixed Mode: Disable (dropdown menu)
- WPA Group Key Update Timer: 1800 (seconds)

At the bottom of the configuration area, there are two buttons: 'Apply' (highlighted with a red circle) and 'Reset'.

- *Configuration for your PC*

1. Double click on your wireless utility icon(here is the Centrion on Windows XP) in your windows task bar the utility will pop up on your windows screen.

2. Select the **wireless card** that you want to configure.

3. Select **on** from the Switch Radio.

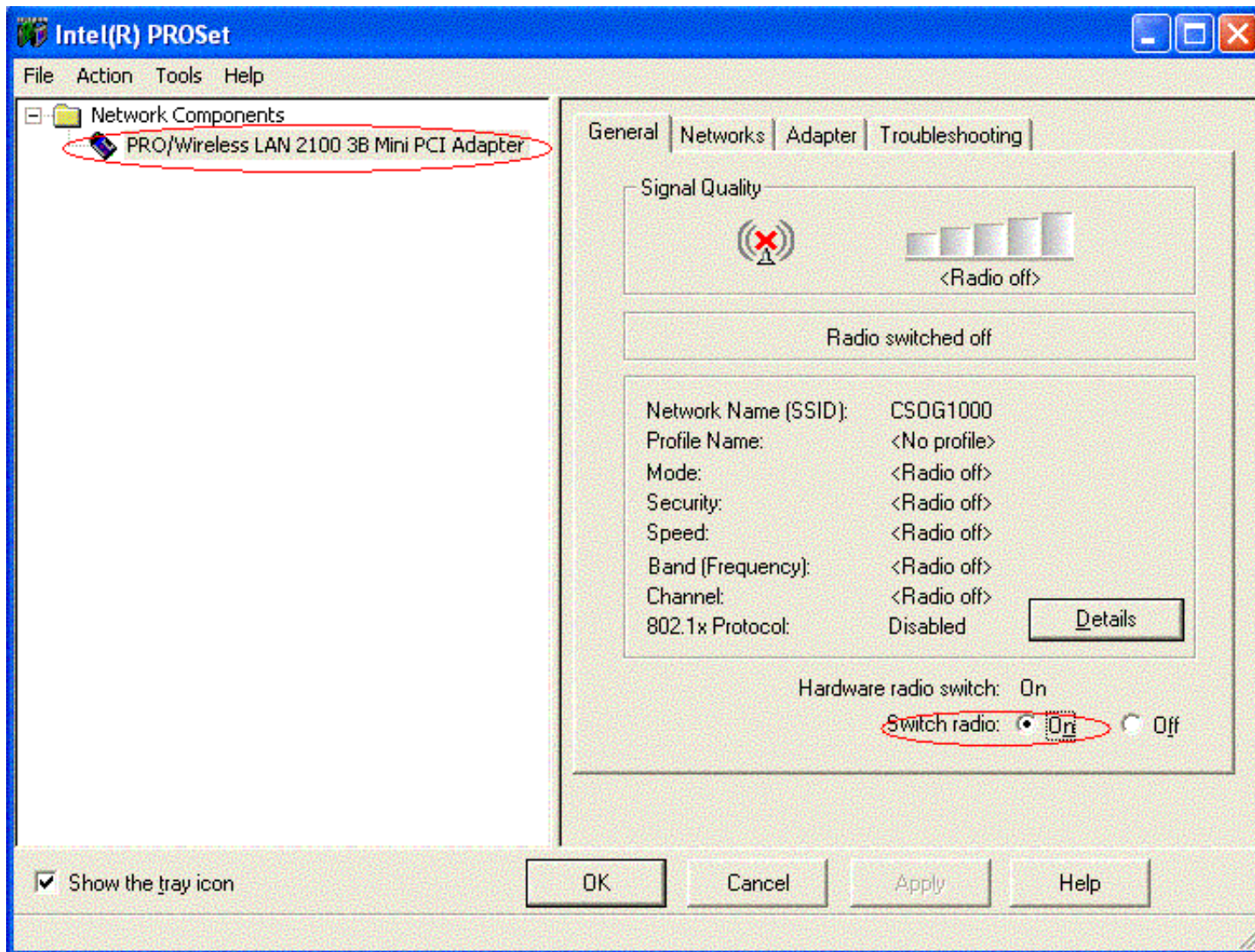

4. choose **Network** option.

5. **Add** a new wireless profile.

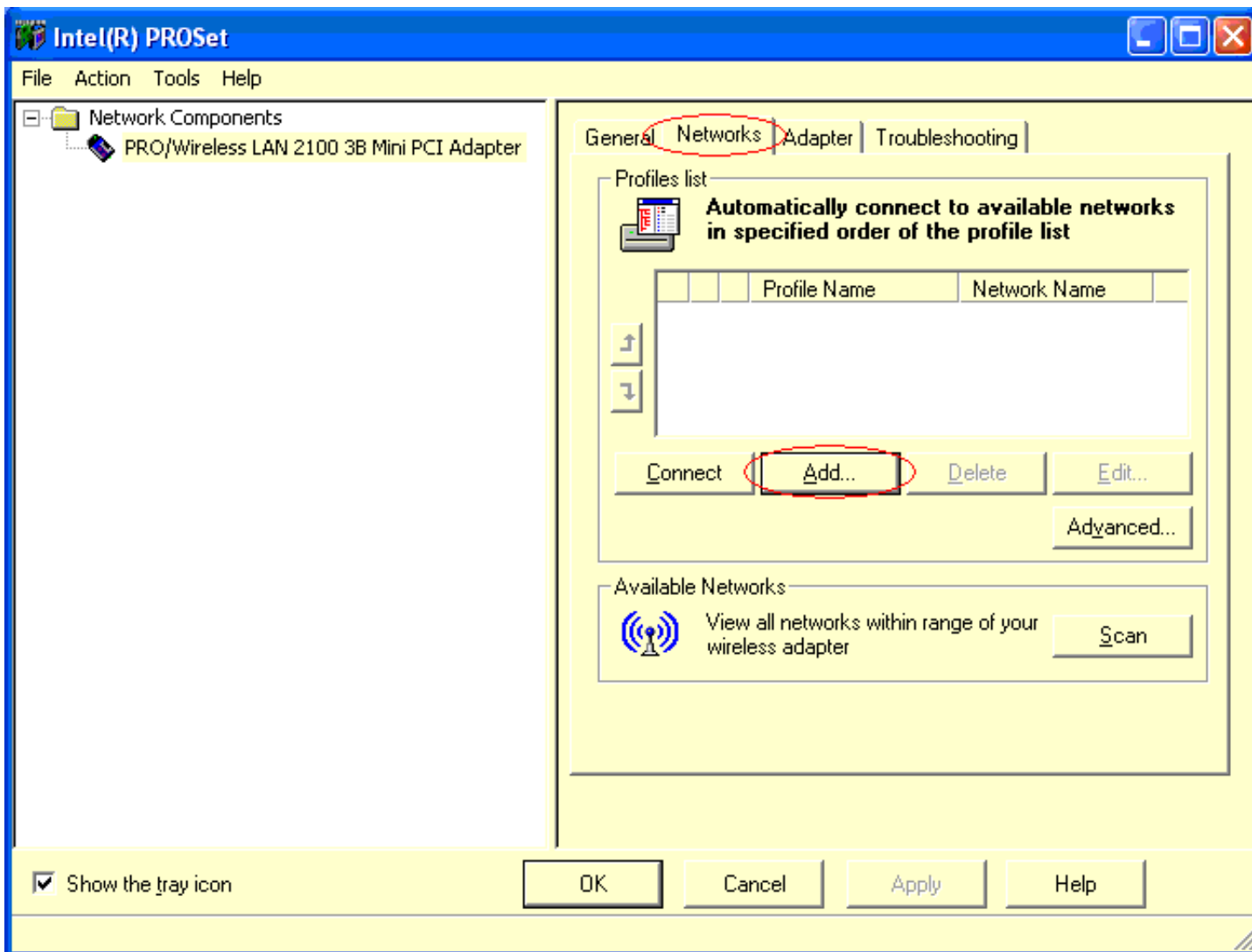

6. Type the **Profile Name** and **Network Name (SSID)** in the field.

7. Click **Next** button.

Profile Wizard: Step 1 of 2

General Settings

Profile Name: BT

Network Name (SSID): BT

Operating Mode:

Infrastructure - Connect to an Access Point

Ad hoc - Connect directly to other computers

Password protect this profile

Advanced Network Settings

Mandatory AP

Enable Cisco Client extensions

< Back **Next >** Cancel Help

Enable Auto-Import

8. Select **WPA-PSK** from the **Network Authentication** field.
9. Select **TKIP** from the **Data Encryption** field.
10. Type the **Pre Share Key** (8-63 character) in the **Pass phrase** field.
11. Click **Finish** to exit the **Profile Wizard** screen.

Profile Wizard: Step 2 of 2

Security Settings

Network Authentication: WPA-PSK

Data Encryption: TKIP

WPA Pre Shared Key Settings

Set Manual Key Encryption Level: 64-bit

Use pass phrase (8 - 63 character values required) Key index: 1

Pass phrase: 12345678

Use hex key (64 hexadecimal values required)

Key: _____

802.1x Settings

802.1x Enabled

Authentication Type: None [Configure >>](#)

Enable Auto-Import

< Back **Finish** Cancel Help

12. After you finished the profile settings, choose the profile you configured. Then, click **Connect** button to associate with the Access Point.

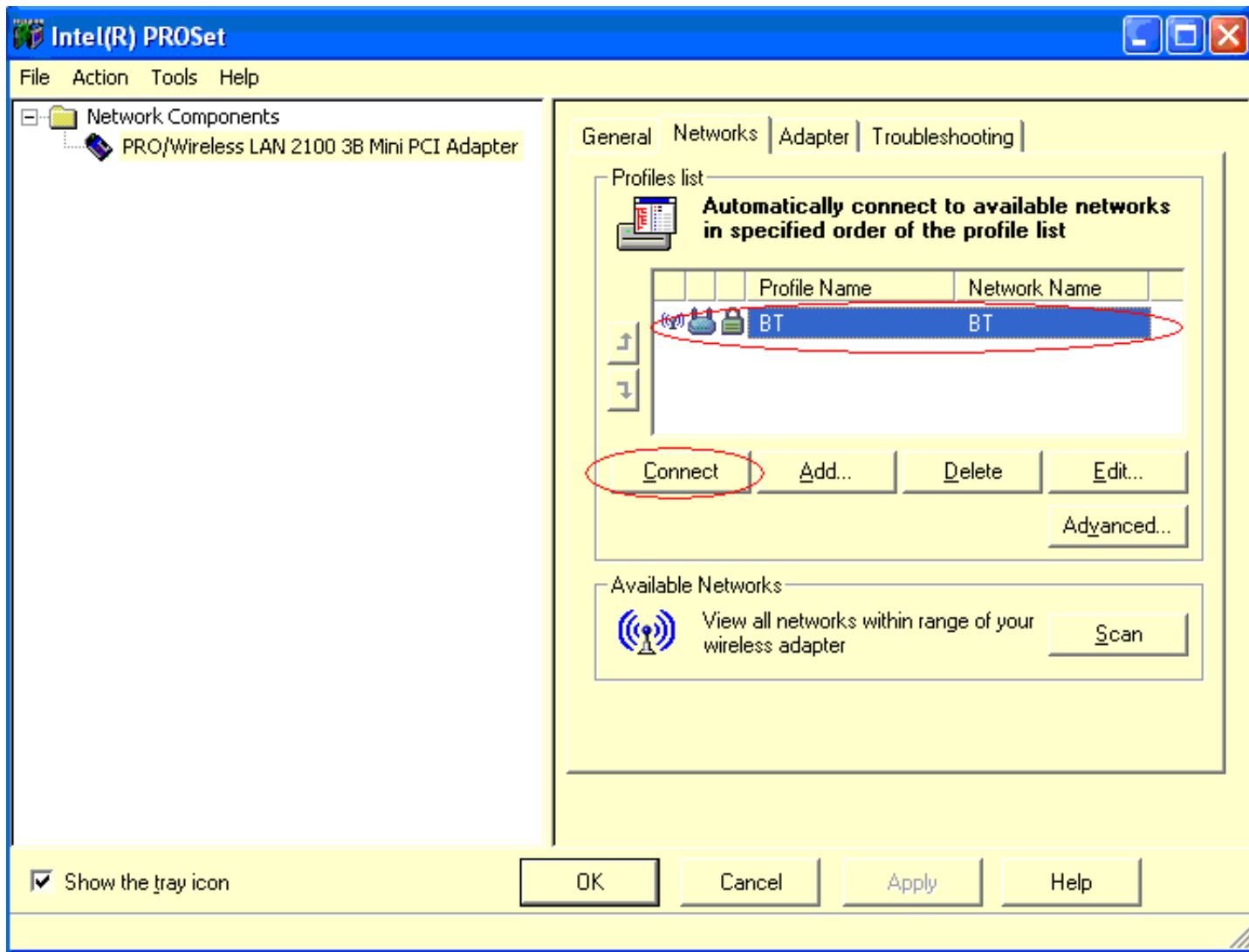

13. Click the General option, we will see the following information, that means the PC associated and authenticated with AP successfully.

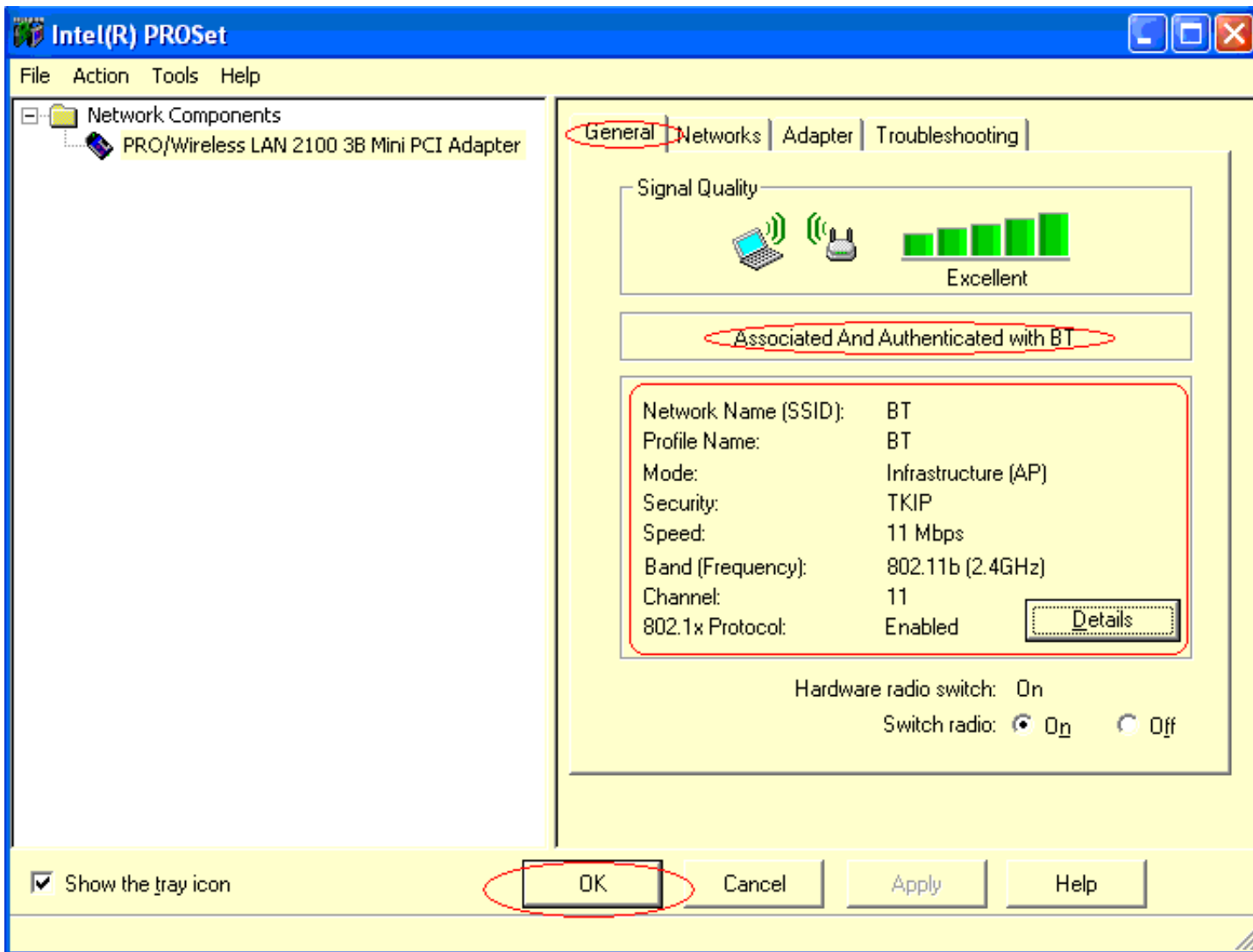

CI Command List

Command Class List Table

System Related Command	Exit Command	Ethernet Related Command
Wireless LAN Related Command	IP Related Command	Bridge Related Command
802.1x Related Command		

System Related Command

[Home](#)

Command				Description
sys				
	adjtime			retrive date and time from Internet
	callhist			
		display		display call history
		remove	<index>	remove entry from call history
	countrycode		[countrycode]	set country code
	date		[year month date]	set/display date
	domainname			display domain name
	edit		<filename>	edit a text file
	extraphnum			maintain extra phone numbers for outcalls
		add	<set 1-3> <1st phone num> [2nd phone num]	add extra phone numbers
		display		display extra phone numbers
		node	<num>	set all extend phone number to remote node <num>
		remove	<set 1-3>	remove extra phone numbers
		reset		reset flag and mask

feature			display feature bit
hostname		[hostname]	display system hostname
log			
	clear		clear log error
	disp		display log error
	online	[on/off]	turn on/off error log online display
rn			
	load	<entry no.>	load remote node information
	disp	<entry no.>(0:working buffer)	display remote node information
	nat	<none sua full_feature>	config remote node nat
	nailup	<no yes>	config remote node nailup
	save	[entry no.]	save remote node information
stdio		[second]	change terminal timeout value
systemname		[system name]	Change system name
time		[hour [min [sec]]]	display/set system time
trcdisp	parse, brief, disp		monitor packets
trclog			
trcpacket			
syslog			
	server	[destIP]	set syslog server IP address
	facility	<FacilityNo>	set syslog facility
	type	[type]	set/display syslog type flag
	mode	[on/off]	set syslog mode
version			display RAS code and driver version
view		<filename>	view a text file

	wdog			
		switch	[on/off]	set on/off wdog
		cnt	[value]	display watchdog counts value: 0-34463
	romreset			restore default romfile
	socket			display system socket information
	filter			
		netbios		
	cpu			
		display		display CPU utilization

Exit Command

[Home](#)

Command				Description
exit				exit smt menu

Ethernet Related Command

[Home](#)

Command				Description
ether				
	config			display LAN configuration information
	driver			
		cnt		
			disp <name>	display ether driver counters
		ioctl	<ch_name>	Useless in this stage.
		status	<ch_name>	see LAN status

	version			see ethernet device type
	edit			
		load	<ether no.>	load ether data from spt
		save		save ether data to spt

Wireless LAN Related Command

[Home](#)

Command				Description
wlan				
	active		[on/off]	set on/off wlan
	association			display association list
	chid		[channel id]	set channel
	diagnose			self-diagnostics
	essid		[ess id]	set ESS ID
	scan			scan wireless channels
	version			display WLAN version information
wlan1				
	active		[on/off]	set on/off wlan
	association			display association list
	chid		[channel id]	set channel
	diagnose			self-diagnostics
	essid		[ess id]	set ESS ID
	scan			scan wireless channels
	version			display WLAN version information

IP Related Command

[Home](#)

Command				Description
ip				
	address		[addr]	display host ip address
	arp			
		status	<iface>	display ip arp status
	dhcp		<iface>	
		client		
			release	release DHCP client IP
			renew	renew DHCP client IP
		status	[option]	show dhcp status
	dns			
		query		
		stats		
	httpd			
	icmp			
		status		display icmp statistic counter
		discovery	<iface> [on off]	set icmp router discovery flag
	ifconfig		[iface] [ipaddr] [broadcast <addr> mtu <value> dynamic]	configure network interface
	ping		<hostid>	ping remote host
	route			
		status	[if]	display routing table
		add	<dest_addr default>[/<bits>] <gateway> [<metric>]	add route
		addiface	<dest_addr default>[/<bits>] <gateway> [<metric>]	add an entry to the routing table to iface
		addprivate	<dest_addr default>[/<bits>] <gateway> [<metric>]	add private route

	drop	<host addr> [/<bits>]	drop a route
	status		display ip statistic counters
	udp		
	status		display udp status
	rip		
	tcp		
	status	[tcb] [<interval>]	display TCP statistic counters
	telnet	<host> [port]	execute telnet clinet command
	tftp		
	traceroute	<host> [ttl] [wait] [queries]	send probes to trace route of a remote host
	xparent		
	join	<iface1> [<iface2>]	join iface2 to iface1 group
	break	<iface>	break iface to leave ipxparent group

Bridge Related Command

[Home](#)

Command			Description
Bridge			
	cnt		related to bridge routing statistic table
	disp		display bridge route counter
	clear		clear bridge route counter
	stat		related to bridge packet statistic table
	disp		display bridge route packet counter
	clear		clear bridge route packet counter

802.1x Related Command

[Home](#)

Command				Description
8021x				
	radius	authentication	Show	show current radius authentication server configuration
		accounting	Show	show current radius accounting server configuration
	debug	reauth	<0:off 1:on>	set IEEE802.1x reauthentication method
		level	[debug level]	set ieee802.1x debug message level
		trace		show all supplications in the supplication table
		user	[username]	show the specified user status in the supplicant table

Wireless Troubleshooting

- [Is it a hardware problem](#)
 - [How can I check to be sure if I am interfered or not](#)
 - [If I've confirmed it is an interference problem. What should I do](#)
 - [What should I do if I have low signal or high noise](#)
 - [Unable to associate to the access point](#)
 - [Unable to authenticate to the access point](#)
 - [Unable to get an IP address via DHCP](#)
 - [Unable to transmit traffic](#)
 - [What should I get back to my technical support for analysis](#)
-

Is it a hardware problem ?

If following symptoms happen on the access point

- None of the LEDs turn on when I plug in the power adapter

Make sure you are using the supplied power adapter and that it is plugged in to an appropriate power source. Check that the power source is turned on. If the problem persists, you may have a hardware problem. In this case, you should contact your local vendor.

- The ZyAIR reboots automatically sometimes

The supplied power to ZyAIR is too low. Check that the ZyAIR is receiving enough power. ;@

How can I check to be sure if I am interfered or not ?

There may not be an easy or quick answer to this. One thing to notice first is whether the problems are continuous or intermittent. Interference usually occurs intermittently, or else it would have likely been noticed when the link was first commissioned.

If I've confirmed it is an interference problem. What should I do?

Change the location and choose other radio channel to see whether the impact of the interference decreases and the link quality improves.

What should I do if I have low signal or high noise ?

To improve the signal, check or get the antennas with reverse SMA type connectors. For noise problems, please shield or remove the interference. If the situation doesn't improve, please change radio channels.

Unable to associate to the access point

1. Verify that the PC card or PCI adapter is installed correctly.
2. Is the signal strength and link quality good ? Move closer to the access point to see if it helps ? If not, you may have radio problems. Make sure you are in the wireless coverage of your access point.
3. Temporarily disable the WLAN MAC Filter function on the access point. If this solves the problem, check to make sure the MAC address of the wireless client is not contained in the list of denied MAC addressed.
4. Temporarily disable any security feature on both the access point and the client. If this solves the problem, check to make sure that the Wired Equivalent Privacy (WEP) key you use to transmit data is set up exactly the same on your AP and on any wireless devices with which it associates.
5. Make sure the configuration on access point and wireless consistent. Verify that the configuration for the SSID on PC matches the access point's ESSID.

You can verify the result of association by using wireless client utility or entering command "**wlan association disp**" in SMT Menu 24.8..

```
G-5100> wlan association disp
[NUM] MAC Address Association time
-----
[001] 0x00:0x60:0xb3:0x69:0x03:0x37 00:00:02 2000/01/01 1
-----
Total: 1
```

Unable to authenticate to the access point

If your client adapter is unable to authenticate to an access point, check the security settings of your client adapter and the access point. These include the following areas:

Authentication with shared key (WEP):

If you use WEP shared key to authenticate the wireless clients, you should check whether following configuration parameters on both AP and wireless clients match:

- WEP key values, WEP key sizes, WEP activation, and WEP transmit key parameters

;
@

Authentication with 802.1X:

If 802.1X security is used in your network, you can troubleshoot the authentication through SMT Menu 24.3.1 - System Maintenance - Log and Trace. Here is the format of the log message: **[user] [mac of user's STA] [type] [message]**

;
@

802.1X with built-in user account:

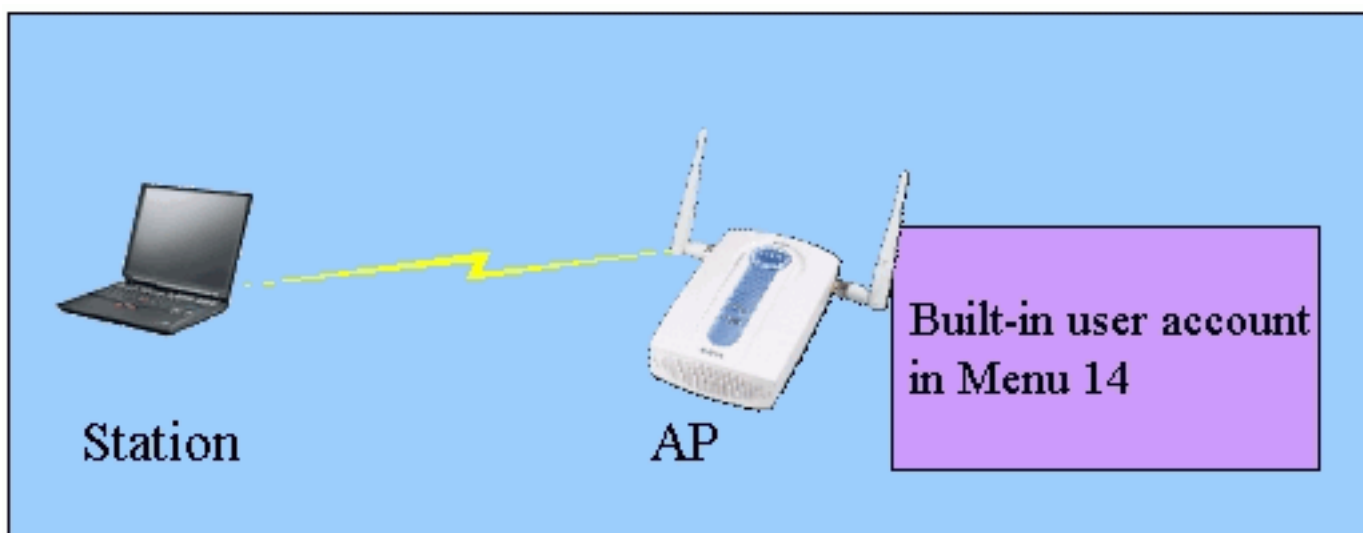

```
[test] [0:a:8a:a2:ae:4e] [login success] [accepted by profiles]
```

```
[test] [0:a:8a:a2:ae:4e] [login fail] [user password error related to profiles]
```

```
[mars] [0:a:8a:a2:ae:4e] [login fail] [user not found in profiles]
```

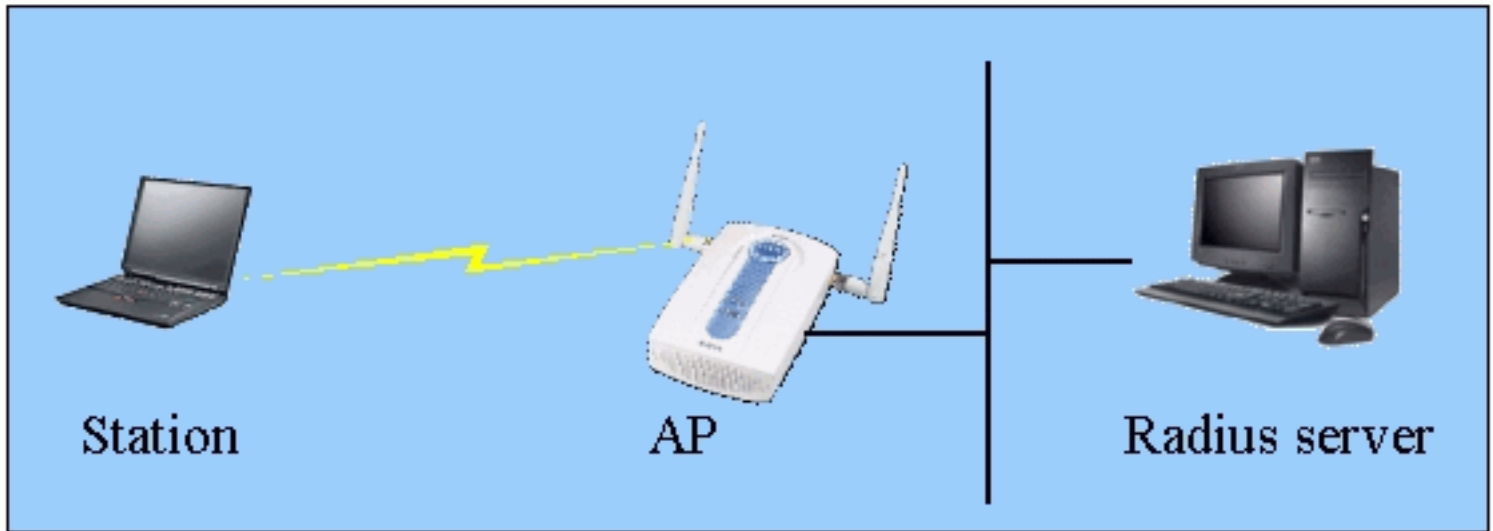
802.1X with RADIUS server:

```
[test] [0:60:b3:69:3:37] [login fail] [rejected by RADIUS server]
```

```
[test] [0:60:b3:69:3:37] [authenticating ...] [no response from RADIUS server]
```

```
[test] [0:60:b3:69:3:37] [logout] [user requested]
```

Note: Some wireless clients (for example, Symbol PCMCIA client) support open authentication and WEP encryption for data traffic. To support these clients in your network, you need to select either 'Open System' or 'Auto' for authentication method when WEP is enable. If you have a mix network which mean there are adapter from different vendor, the suggest configuration is 'Auto'. The system will automatically detect your adapter type and auto configure to the client adapter when WEP is enabled.

Unable to get an IP address via DHCP

1. Verify that the DHCP server service is running.
2. The other wired clients on the same segment are able to be successfully addressed dynamically.
3. Verify that the ethernet interface on the access point is up.
4. Verify that the client has passed association and authentication to the access point.
5. Verify that the Wired Equivalent Privacy (WEP) key on the client is set up exactly the same on

your AP.

Unable to transmit traffic

1. Verify that the client has passed association and authentication.
 2. Make sure the client is configured with exact IP setting or get a valid IP address from DHCP server. You can go to a DOS prompt and type: **ipconfig** and press Enter to verify this.
 3. Ping the gateway in your network. A response other than Request timed out indicates a successful ping.
 4. Enable packet trace function on the access point Verify that the Wired Equivalent Privacy (WEP) key on the client is set up exactly the same on your AP.
-

What should I get back to my technical support for analysis ?

Following information are helpful to your technical support to troubleshoot your problem, please get back the answer and associated files to your support:

1. Is this a new or existing installation ?
 2. Did it work before ?
 3. Have there been any recent changes that might affect the LAN, the client workstation or the radio environment ?
 4. What is the firmware version you are using now ? Do you have uploaded firmware recently ?
 5. Is addresses, networking information and ROMFILE available ? If yes, please send it (include your password) to your support.
-

All contents copyright (c) 2003 ZyXEL Communications Corporation.